

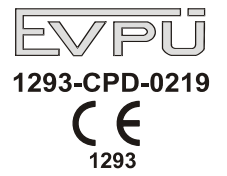

**Interactive Fire Control Panel  
IFS7002  
four signal loops**



**Instruction Manual**

Revision 4/16.08.10

## Contents

<b>1. Introduction</b> .....	<b>6</b>
<b>2. Terminology</b> .....	<b>6</b>
<b>3. Function</b> .....	<b>8</b>
<b>4. Technical data</b> .....	<b>8</b>
<b>4.1. Physical configuration</b> .....	<b>8</b>
<b>4.2. Fire alarm zones</b> .....	<b>8</b>
<b>4.3. Fire alarm loops</b> .....	<b>9</b>
<b>4.4. Power loop</b> .....	<b>9</b>
<b>4.5. Monitored outputs</b> .....	<b>9</b>
<b>4.6. Relay output for fire conditions</b> .....	<b>9</b>
<b>4.7. Programmable relay output</b> .....	<b>9</b>
<b>4.8. Relay output for fault conditions</b> .....	<b>9</b>
<b>4.9. Performance</b> .....	<b>9</b>
<b>4.10. Indications of registered events</b> .....	<b>9</b>
<b>4.11. Power supply</b> .....	<b>9</b>
4.11.1. Mains.....	10
4.11.2. Back up batteries .....	10
4.11.3. Consumption on back up batteries supply.....	10
4.11.4. Power supply to external devices .....	10
<b>4.12. Dimensions</b> .....	<b>10</b>
<b>4.13. Weight</b> .....	<b>10</b>
<b>5. Contents of delivery</b> .....	<b>10</b>
<b>6. General information</b> .....	<b>10</b>
<b>6.1. Access levels</b> .....	<b>10</b>
6.1.1. Access Level 1 .....	10
6.1.2. Access Level 2 .....	11
6.1.3. Access Level 3 .....	11
6.1.4. Access Level 4 .....	11
<b>6.2. Indications and buttons for control</b> .....	<b>11</b>
<b>6.3. Zone in Coincidence Mode</b> .....	<b>12</b>
<b>6.4. Addressing, initialization, re-initialization</b> .....	<b>15</b>
6.4.1. Addressing .....	15
6.4.2. Initialization .....	15
6.4.3. Re-initialization.....	16
<b>6.5. Operation of the fire control panel</b> .....	<b>17</b>
<b>7. Duty Mode</b> .....	<b>18</b>
<b>7.1. Description</b> .....	<b>18</b>
<b>7.2. Indication</b> .....	<b>18</b>
7.2.1. LED and sound indication.....	18
7.2.2. Text message.....	18
<b>7.3. Using the keypad</b> .....	<b>19</b>
<b>8. Fire condition</b> .....	<b>19</b>

<b>8.1. Description .....</b>	<b>19</b>
<b>8.2. Indication .....</b>	<b>19</b>
8.2.1. LED and sound indication.....	19
8.2.2. Text messages .....	19
<b>8.3. Using the keypad .....</b>	<b>20</b>
<b>9. Fault Condition .....</b>	<b>23</b>
<b>9.1. Description .....</b>	<b>23</b>
<b>9.2. Indication .....</b>	<b>24</b>
9.2.1. LED and sound indication.....	24
9.2.2. Text messages .....	24
<b>9.3. Using the keypad .....</b>	<b>25</b>
<b>10. Disabled component .....</b>	<b>26</b>
<b>10.1. Description .....</b>	<b>26</b>
<b>10.2. Indication .....</b>	<b>26</b>
10.2.1. LED and sound indication.....	26
10.2.2. Text messages .....	26
<b>10.3. Using the keypad .....</b>	<b>26</b>
<b>11. Test Mode.....</b>	<b>26</b>
<b>11.1. Description .....</b>	<b>26</b>
<b>11.2. Indicators .....</b>	<b>27</b>
11.2.1. LEDs and sound indicators .....	27
11.2.2. Text messages .....	27
<b>11.3. Using the keypad .....</b>	<b>27</b>
<b>12. Information and Control Mode.....</b>	<b>27</b>
<b>12.1. Description .....</b>	<b>27</b>
<b>12.2. Menu Lists .....</b>	<b>28</b>
12.2.1. Menu <i>Faults</i> .....	28
12.2.2. Menu <i>Disables</i> .....	29
12.2.3. Menu <i>Zones in Test</i> .....	31
12.2.4. Menu <i>Input messages</i> .....	32
12.2.5. Menu <i>Activated Outputs</i> .....	33
12.2.6. Menu <i>Screen Panel configuration</i> .....	35
12.2.7. Menu <i>Panel parameters</i> .....	35
12.2.8. Menu <i>Loops</i> .....	36
12.2.9. Menu <i>Zones</i> .....	38
12.2.10. Menu <i>Device Status</i> .....	41
12.2.11. Menu <i>Inputs</i> .....	44
12.2.12. Menu <i>Archive</i> .....	46
12.2.13. Menu <i>Select Loc/Rem. Control Panel</i> .....	52
<b>12.3. Menu System functions .....</b>	<b>52</b>
12.3.1. Menu <i>Disables</i> .....	53
12.3.2. Menu <i>Zones in Test</i> .....	57
12.3.3. Function <i>Set Clock</i> .....	58
12.3.4. Function <i>Set Mode</i> .....	58
12.3.5. Function <i>Check LEDs and Buzzer</i> .....	59
<b>12.4. Menu Set Up .....</b>	<b>60</b>
<b>13. Set Up Mode.....</b>	<b>60</b>
<b>13.1. Description .....</b>	<b>60</b>

<b>13.2. Menu Panel configuration</b> .....	<b>61</b>
<b>13.3. Menu Panel parameters</b> .....	<b>62</b>
<b>13.4. Menu Loops</b> .....	<b>62</b>
13.4.1. Menu Loop parameters .....	62
13.4.2. Screen List Devices .....	63
13.4.3. Menu Device parameters .....	63
13.4.4. Function Check up.....	69
13.4.5. Function Manual addressing.....	70
<b>13.5. Menu Zones</b> .....	<b>78</b>
13.5.1. Menu Devices.....	79
13.5.2. Menus Fire Phase 1 Outputs and Fire Phase 2 Outputs .....	84
13.5.3. Menu Zone parameters .....	87
13.5.4. Menu Service Rem. Zones .....	88
13.5.5. Screen Text message .....	88
<b>13.6. Menu Inputs</b> .....	<b>90</b>
13.6.1. Screen List of addressable outputs .....	91
13.6.2. Menu Remove addressable output .....	91
13.6.3. Menu Add addressable output.....	92
13.6.4. Screen Outputs activation mode.....	93
13.6.5. Menu Text message .....	93
<b>13.7. Menu Initialization</b> .....	<b>95</b>
13.7.1. Function Initialization .....	96
13.7.2. Function Clean initialization.....	97
13.7.3. Menu Readdressing.....	99
13.7.4. Menu Exclude devices.....	100
13.7.5. Menu Check .....	101
<b>13.8. Menu Checks</b> .....	<b>103</b>
13.8.1. Menu Monitored outputs .....	103
13.8.2. Menu Relay outputs.....	103
13.8.3. Menu Addressable outputs .....	104
13.8.4. Function Display .....	105
13.8.5. Menu Buttons .....	105
<b>13.9. Menu New passwords</b> .....	<b>107</b>
13.9.1. Menu Level 2.....	107
13.9.2. Function Level 3.....	107
<b>13.10. Function Default parameters</b> .....	<b>108</b>
<b>13.11. Function Clear archive</b> .....	<b>109</b>
<b>14. Saving the parameters</b> .....	<b>110</b>
<b>15. Labour protection requirements</b> .....	<b>110</b>
<b>16. Installation and arrangements</b> .....	<b>110</b>
<b>16.1. To mount the fire control panel</b> .....	<b>110</b>
<b>16.2. Periphery devices assembly</b> .....	<b>111</b>
16.2.1. Mounting periphery devices to monitored outputs.....	111
16.2.2. Mounting periphery devices to relay outputs .....	111
<b>16.3. Connecting interface devices</b> .....	<b>111</b>
16.3.1. Global network.....	111
16.3.2. Local network .....	111
<b>16.4. Connecting addressable fire detectors</b> .....	<b>111</b>
<b>16.5. Power supply connection</b> .....	<b>112</b>
<b>17. Fire control panel start up</b> .....	<b>112</b>

---

<b>17.1. Sequence of start up .....</b>	<b>112</b>
<b>17.2. Clean initialization of loops .....</b>	<b>113</b>
17.2.1. Clean initialization of loops with automated addressing .....	113
17.2.2. Clean initialization of loops set to manual addressing .....	114
<b>18. Troubleshooting.....</b>	<b>116</b>
<b>19. Conditions of operation, storage and transportation .....</b>	<b>118</b>
<b>19.1. Operation and storage.....</b>	<b>118</b>
19.1.1. Temperature .....	118
19.1.2. Relative humidity .....	118
<b>19.2. Transportation.....</b>	<b>118</b>
<b>20. Warranty .....</b>	<b>118</b>
<b>21. Appendixes.....</b>	<b>119</b>

## 1. Introduction

Interactive Fire Control Panel IFS 7002 is an up-to-date, high reliable, multifunctional and versatile device, providing the user with unexpected potential in the design, installation and operation of addressable fire alarm systems.

Some of its main features and possibilities are:

- Adjustment of operating modes and parameters of each fire alarm line via built in keypad;
- User oriented menu dialogue for easy and convenient operation;
- LCD for visualization of system checkup and setup modes;
- Touch-panel contributing to the creation of a dynamic keypad;
- LEDs indication for early warning of a break down or extreme conditions;
- Energy independent archive memory saving the event type, date and time, allowing for detailed analysis of the actions of the authorized personnel and of possible problems in the fire protection process of the area;
- User oriented test modes allowing for a total control of the site protected;
- Built-in serial interface for connection to other fire control panels of similar or higher level;
- Built-in serial interface for connection to second level control devices, ability for connection via telephone line and a standard modem;
- System expansion and functional modification (our goal is to constantly improve the fire alarm equipment features), no additional cabling necessary;
- Compatible to random installation design, within the range of the available fire control panels resources.

All these are realizable via fire control panel's keypad and after a detailed examination of the instructions set herewith.

## 2. Terminology



**ADDRESSING** – the method used for assigning addresses to addressable devices in a fire alarm loop. The addressing can be automated or manual and shall be performed separately for each fire alarm loop (see section 6.4.1).

**ADDRESSABLE OUTPUT** – potential or relay output of an addressable executive device included in *fire alarm loops*. The executive device can be power supplied from the *fire alarm loop* or from the *power supply loop*.

**ADDRESSABLE DEVICE** – a device included in one of the *fire alarm loops* that has its own address for communication with the fire control panel. An addressable device can be a fire detector (automatic or manual call point), a conventional line-monitoring module or an input/output module.

**ASSOCIATED OUTPUT** – *addressable monitored or relay output*, user programmed to react upon Fire condition (separately upon *Fire condition I* and *Fire condition II*) via selected *fire alarm zone*.

**INSPECTION TIME** – period of time added to the remaining time, before the system proceeds from *Fire condition stage I* to *Fire condition stage II*, when button  is pressed. Usually, this period of time is long enough for the authorized personnel to check up the indicated premises. The inspection time is user defined and is specified for each *zone*.

**PROCEEDING FROM FIRE CONDITION STAGE I TO FIRE CONDITION STAGE II** – the time is user defined for each *zone* separately. During the phase *Fire condition stage I* the remaining time for the selected fire alarm line is indicated on the LCD display. During the remaining time actions can be taken, for example press  or .

**DISABLED ZONE** – a *zone* that is not controlled for activated fire detectors and fault condition. This condition is user defined. The indication for a disabled zone is common light indication and text messages on the LCD display.

**DISABLED ADDRESSABLE/MONITORED OUTPUT** – *the addressable/ monitored output* is switched off (the executive device can not be activated) and is not monitored for a fault condition. This feature is user defined. The indication for a disabled addressable/monitored output is common light indication and text messages on the LCD display.

**DISABLED DEVICE** – the addressable device (a fire detector) is switched off and is not monitored for a fault condition. This feature is user defined. The indication for a disabled device is common light indication and text messages on the LCD display.

**SHORT CIRCUIT IN A LOOP** – *non-fatal fault condition*, entered due to registered current value in a *loop*, exceeding a threshold value. The threshold value for each loop shall be user defined.

**ZONE IN TEST** – a *zone* set in Test condition by the user. The zone is reset (the fire detectors in fire condition receive a command to clear the condition) periodically every 60 s. The events registered in a zone in Test condition are not saved in the archive and do not trigger the associated outputs or the light and sound signalling. The indication for a zone in Test condition is common light indication.

**SWITCHED-OFF ADDRESS** – an address that will be skipped during initialization of a fire alarm loop (see section 6.4.2). The feature allows including devices in the fire alarm loop later, without re-assigning addresses to current devices.

**INITIALIZATION** – a process during which addresses are being assigned to addressable devices in a fire alarm loop. The initialization can be two types – clear initialization and standard initialization (see section 6.4.2).

**MONITORED OUTPUT** – a potential output that monitors the serviceability of the connection wires between the fire control panel and the executive device. Follow the special diagram for connection.

**SHORT CIRCUIT IN A MONITORED OUTPUT** – *non-fatal fault condition*, entered due to registered current value in a *monitored output*, exceeding a threshold value.

**LOCAL SOUNDER** – a sounder built-in the fire control panel.

**NON-FATAL FAULT CONDITION** – fault condition that allows the fire control panel to continue operation. The indication is common light indication, local sound indication and text messages on the LCD display.

**ACCESS LEVEL** – access level to various indications and control functions.

**LOW BATTERY** – *fatal fault condition* due to full discharge of the backup batteries upon interrupted power supply.

**GROUNDING** – *non-fatal fault condition*, due to leakage to a grounded wire.

**FIRE ALARM ZONE** (further on it will be referred as ZONE) – logical unification of automatic fire detectors and addressable manual call points, physically allocated in fire alarm loops on random principle. Interactive Fire Control Panel IFS7002 allows for formation of a maximum of 500 zones. Up to 60 fire detectors can be integrated in each zone.

**FIRE ALARM LOOP** (further on it will be referred as LOOP) – automatic fire detectors and addressable manual call points and addressable executive devices, physically connected by the means of two-wire connection. The basic configuration of IFS 7002-4I loops includes 4 fire alarm

loops; a maximum of 125 devices (addressable fire detectors and/or addressable executive devices) can be integrated into each loop.

**FIRE CONDITION STAGE I** – phase 1 of Fire condition; upon activation of automatic fire detector the fire control panel enters Fire condition until the specified time expires. The common and local light indicators, local sound signaling and a text message displayed on the LCD display indicate the phase.

**FIRE CONDITION STAGE II** – phase 2 of Fire condition; the fire control panel enters Fire condition stage II when: a) the time for *Fire condition stage I* has expired or b) upon activation of a manual call point. The common light indicators, local sound signaling and a text message displayed on the LCD display indicate the phase.

**INTERRUPTED LOOP OR MONITORED OUTPUT** – *non-fatal fault condition* due to current value in a *loop* or in *monitored output* lower than the threshold value. The user shall define the threshold value separately for each loop.

**COINCIDENCE MODE**– mode of operation of the fire alarm zones, that requires activation of at least two automatic fire detectors in a zone so the fire control panel is able to enter *Fire condition*, phase *Fire condition stage I*, in this particular zone (see section 6.3).

**RELAY OUTPUT** – a relay, potential-free switching outputs provided for controlling external executive devices.

**POWER LOOP** – a two-wire connection supplying power to addressable executive devices in case their consumption exceeds the load carrying capacity of the fire alarm loops, which they have been integrated into. IFS7002 has 1 power loop, its load carrying capacity is 1000 mA.

**SYSTEM ERROR** – *fatal fault condition* due to a fault in system's basic component

**SYSTEM OPERATION** – the fire control panel executes internal operations to set its registers. This is visualized on the LCD display with a text message for system operations, before the user is allowed to proceed with his work with IFS7002.

**DEVICE REMOVED** – *non-fatal fault condition* due to removed device (addressable fire detector of a specific zone and/or addressable executive device).

**FATAL FAULT CONDITION** – fault condition that prevents the fire control panel from continuing its operation. The indication is common light indication, local sound indication and text messages on the LCD display.

### **3. Function**

Interactive Fire Control Panel IFS7002 with four signal loops is designed to operate with addressable automatic fire detectors and manual call points. It controls addressable executive devices integrated into fire alarm loops. The addressable executive devices can be power supplied from the fire alarm loop or from a power loop. The panel has outputs provided for integration of external executive devices.

### **4. Technical data**

#### 4.1. Physical configuration

- 4 fire alarm loops
- 1 power loop
- 2 monitored outputs
- 1 relay outputs for fire condition
- 1 programmable relay output for fire condition stage I and/or stage II
- 1 relay output for fault conditions

#### 4.2. Fire alarm zones

- Maximum number of zones - 500



- Maximum number of fire detectors in a zone - 60
- 4.3. Fire alarm loops
  - Maximum number of fire detectors in a loop - 125
  - Connecting line - two-wire shielded
  - Maximum resistance of a loop - 80 $\Omega$
  - Output resistance of a loop - 10 $\Omega$
  - Maximum consumption of a loop - 200mA
- 4.4. Power loop
  - Connecting line - two-wire
  - Maximum resistance of the loop - 10 $\Omega$
  - Output resistance of the loop - 0.78 $\Omega$
  - Maximum consumption of the loop - 1A
- 4.5. Monitored outputs
  - Type - potential
  - Electrical characteristics - (24 $\pm$ 5)V/1A
- 4.6. Relay output for fire conditions
  - Type - potential free, switching,
  - Electrical characteristics - 3A/125VAC; 3A/30VDC
- 4.7. Programmable relay output
  - Type - potential free, switching,
  - Electrical characteristics - 3A/125VAC; 3A/30VDC
- 4.8. Relay output for fault conditions
  - Type - potential free, switching
  - Electrical characteristics - 3A/125VAC; 3A/30VDC
- 4.9. Performance
  - Control over fire alarm loops and monitored outputs for fault conditions (short circuit and interruption) and automatic reset
  - Detection of removed devices in the loops and automatic reset
  - Ability to set the zones in Coincidence Mode
  - Two phases of Fire condition, programmable time for Fire condition stage I, separately for each zone
  - Option for setting the fire detectors belonging to one zone in Coincidence Mode;
  - Option to prolong the time period for Fire condition stage I with programmable inspection period, specified for each zone
  - Built-in sounder for fire condition – one tonal, discontinuous, can be switched off
  - Built-in sounder for fault condition – one tonal, discontinuous, can be switched off
  - Built-in real time clock
  - Set of test modes and options for adjustment:
    - ◆ Setting the clock;
    - ◆ Check ups on light and sound indications;
    - ◆ Test of fire alarm zones;
    - ◆ Adjustment of outputs and integrated external devices;
    - ◆ Programming of parameters and modes of operation;
    - ◆ Remote programming of the parameters from distant operator control point;
  - Energy independent archive of registered events with the events type, date and hour
    - up to 2046 events;
  - Interfaces for communication with external devices - CAN 2.0B and RS-232 (directly or via modem).
- 4.10. Indications of registered events
  - Light indication - LED
  - Text messages - LCD display, graphic  
320 x 240 points, backlit
  - Sound signaling - built-in sounder
- 4.11. Power supply

- |   |                         |
|---|-------------------------|
| 4.11.1. Mains   |                         |
| – voltage   | - 220/230V              |
| – frequency   | - 50Hz                  |
| 4.11.2. Back up batteries   |                         |
| – battery type  | - lead, gel electrolyte |
| – number of batteries   | - 2 pcs                 |
| – connection  | - serial connection     |
| – nominal voltage of the back up battery  | - 2 x 12V               |
| – nominal capacity $C_{20}$   | - 18Ah                  |
| – extreme discharge voltage   | - 21V                   |
| – charge voltage  | - 28,2V                 |
| 4.11.3. Consumption on back up batteries supply                                 |                         |
| – at 24V  | - < 250mA               |
| – at 26V  | - < 240mA               |
| 4.11.4. Power supply to external devices  |                         |
| – Voltage   | - (24±5)V               |
| – Maximum current value (including current of monitored outputs and power loop) | - 5A                    |
| 4.12. Dimensions  |                         |
| – Overall dimensions  | - 493x464x110mm         |
| 4.13. Weight  |                         |
| – Weight (batteries not included)   | - 10kg                  |

### **5. Contents of delivery**

- |  |         |
|--|---------|
| – Fire control panel IFS7002   | - 1 pc  |
| – Resistors 5,6kΩ/ 0,25W   | - 2 pcs |
| – Jumper for the backup batteries  | - 1 pc  |
| – Fuse 4A  | - 1 pc  |
| – Fuse 6,3A  | - 1 pc  |
| – CD with documentation (Instruction Manual, Service Personnel Instruction Manual) | - 1 pc  |
| – Packing  | - 1 pc  |

### **6. General information**

The fire control panel is controlled by means of buttons, shown on the touchscreen. Different buttons are active depending on the chosen menu, screen or function. Observe strictly the requirements for operation with the panel in order to ensure its long lasting performance.

The function of the stylus (pos. 1, fig.1) is to facilitate and provide the safety operation of the touchscreen of fire control panel IFS7002 and repeater IFS7002R.

Tap slightly the stylus point on the displayed button.

The self-sticking support pad (pos.2, fig.1) allows it to be stuck in a convenient place.

It is not recommended to use other objects when operating the touchscreen panel as there is a risk to damage it.

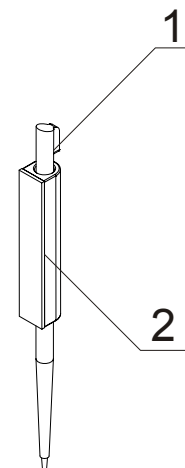

Fig.1

#### 6.1. Access levels

4 levels of access to the variable indications and control functions of IFS7002 are available.

##### 6.1.1. Access Level 1

All persons who would presumably find out and react to alarm upon fault condition or fire condition have access to level 1.

The following actions are accessible:

- Displaying suppressed messages for Fire condition, Fault condition, Disabled components and Zone in test (see sections 8.3.6, 12.2.1, 12.2.2 and 12.2.3);
- Entering inspection time period (see section 8.3.1);
- Forced proceeding from phase Fire condition stage I to phase Fire condition stage II (see section 8.3.3);
- Suppressing the local sounder (see sections 8.3.2 and 9.3.1);
- Displaying text messages from the inputs (see section 12.2.4);
- Displaying program data for the fire control panel (see sections 12.2.6 to 12.2.9 and 12.2.11);
- Displaying the status of the addressable devices in the loops (see section 12.2.10);
- Displaying the archive (see section 12.2.12).

All light indicators are visible.

#### 6.1.2. Access Level 2

The personnel in charge of the fire protection have access to level 2; they shall be authorized and trained to operate the fire control panel in the following conditions:

- Duty Mode;
- Fire condition;
- Fault condition;
- Disabled component;
- Information and adjustment.

To enter Access level 2 use your password.

The following features of the fire control panel are accessible:

- All features accessible at Level 1;
- Switching off the outputs, activated upon fire condition (see section 8.3.4);
- Exit of Fire condition (see section 8.3.5);
- System functions of the fire control panel (see section 12.3).

#### 6.1.3. Access Level 3

Accessible for personnel trained and authorized for:

- Reconfiguration of specific data – of the protected site or of the fire control panel – saved in the memory;
- Maintenance of the fire control panel.

This level has two sublevels of access - 3A and 3B.

Level 3, sublevel 3A, is accessed through a password entered at Access level 2. At this sublevel the functions for reconfiguration of specific data for the protected site or the fire control panel are accessible (see section 13).

Level 3, sublevel 3B is accessed when the fire control panel is opened. The following features are accessible:

- Replacing a burnt fuse;
- Connecting fire alarm loops and executive devices.

#### 6.1.4. Access Level 4







Accessible for personnel trained and authorized by the Producer to repair the fire control panel and to modify the software. Special means are required to enter this level.

### 6.2. Indications and buttons for control

Table 1 gives detail description of the indications for each status, Table 2 presents the basic means for control. Appendix 1 shows the front panel of IFS7002.

**Table 1**

Conditions of the fire control panel	Indication
All conditions - The fire control panel is power supplied	 Indicator <i>Power supply</i> – continuous green light

Conditions of the fire control panel	Indication
Fire condition	 Common indicator <i>Fire condition</i> – flashing red light
Fault condition - All faults except for <i>Battery Low</i>	 Common indicator <i>Fault condition</i> – continuous yellow light
Fault condition – System error	 Indicator <i>System error</i> - continuous yellow light
Fault condition - Fault in mains supply	 Indicator <i>Fault in mains supply</i> - continuous yellow light
Disabled component - Disabled zone, addressable device or monitored output	 Indicator <i>Disabled component</i> - continuous yellow light
Test condition	 Indicator <i>Test</i> – continuous yellow light
Fire condition	Local sounder – discontinuous signal: 0.5 s sound, followed by 0.5s break
Fault condition - All faults except for <i>Battery Low</i>	Local sounder – discontinuous signal: 1 s sound, followed by 1 s break
Fault condition - Low battery	Local sounder – discontinuous signal: 1 s sound, followed by 3 s break

### 6.3. Zone in Coincidence Mode

Coincidence Mode allows for enhanced certainty that a zone has entered Fire condition, phase Fire condition stage I. The mode requires that at least two fire detectors from this zone shall be activated to trigger Fire condition, phase Fire condition stage I in the fire control panel.

The Coincidence Mode is not applicable to manual call points. If a manual call point, included in a zone set to Coincidence Mode, responds, the fire control panel enters Fire condition, phase Fire condition stage II in this particular zone.

Upon activation of an automatic fire detector from a zone set to Coincidence Mode, but the fire control panel has not entered Fire condition in this zone, then:

- If no other automatic fire detector is activated, the zone enters Pre-Fire condition;
- If another automatic fire detector is activated, i.e. the zone is in Pre-Fire condition, then the fire control panel enters Fire condition, phase Fire condition stage I, in this particular zone.











Exit from Pre-Fire condition in a zone is done:











- Upon activation of a second automatic fire detector in the zone (the fire control panel enters Fire condition, phase Fire condition stage I, in this particular zone);
- Upon activation of a manual call point in the zone (the fire control panel enters Fire condition, phase Fire condition stage II, in this particular zone)
- On manual operation from the button “Reset Fire” (password for Access Level 2 is required) – the control panel will send command “Reset to duty mode” to the automatic detector in fire condition.

To set a zone in Coincidence Mode you need to appoint the parameter Coincidence Mode for this zone (see section 13.5.3).

While using the Coincidence Mode in a zone, we recommend you to include just one group of automatic fire detectors (minimum 2 fire detectors) in this zone, allocated in one and the same room, so upon activation of any two fire detectors you obtain a firm indication for fire in the room.

Table 2

Means of control	Condition of the fire control panel	Access level	Operation
Button <i>Reset Fire</i> 	Fire condition	Level 2	To exit the Fire condition
Button <i>Fire condition stage II</i> 	Fire condition, phase <i>Fire condition stage I</i>	Levels 1 and 2	To force transition to phase <i>Fire condition stage II</i>
Button <i>Outputs</i>  (no suppressed outputs) or  (suppressed outputs)	Fire condition	Level 2	- upon activated outputs for fire condition – to suppress the outputs - if no outputs for fire condition are activated – to activate all suppressed outputs
Button <i>Inspection</i> 	Fire condition, phase <i>Fire condition stage I</i>	Levels 1 and 2	To add time period for inspection
Button <i>Stop Alarm</i> 	Fire condition and Fault condition (with the exception of Fatal Fault Condition)	Levels 1 and 2	To suppress the local sounder
Button <i>Menu</i> 	Duty mode, Fire condition, Fault condition (with the exception of Fatal Fault Condition) Test mode and Disabled component	Level 1	To enter Information and Control mode
Button <i>Enter</i> 	Information and Control Mode	Level 1	To enter a selected menu
	Information and Control Mode	Level 2	- To enter a selected menu; - To execute a selected command;
	SetUp Mode	Level 3A	- To save a modified parameter
Button <i>Down</i> 	Information and Control Mode	Levels 1 and 2	To display the next element of the menu
	SetUp Mode	Level 3A	
Button <i>Up</i> 	Information and Control Mode	Levels 1 and 2	To display the previous element of the menu
	SetUp Mode	Level 3A	

Means of control	Condition of the fire control panel	Access level	Operation
Button <i>Exit</i> 	Information and Control Mode	Levels 1 and 2	To exit Information and Control Mode
	SetUp Mode	Level 3A	To exit SetUp Mode and reset the system
Button <i>Cancel</i> 	Information and Control Mode	Levels 1 and 2	- To exit a function without saving changes in the parameter; the command will not be executed; - To exit the current menu and to move to an upper hierarchy menu
	SetUp Mode	Level 3A	
Button <i>Change</i> 	Information and Control Mode	Levels 1 and 2	To change an element to its next permissible
	SetUp Mode	Level 3A	
Button <i>Move down</i> 	Fire condition and Information and Control Mode	Levels 1 and 2	Next element (if any are available) from the left window
	SetUp Mode	Level 3A	
Button <i>Move up</i> 	Fire condition and Information and Control Mode	Levels 1 and 2	Previous element (if any are available) from the left window
	SetUp Mode	Level 3A	
Button <i>Page down</i> 	Information and Control Mode	Level 1	Next page from the left window
Button <i>Page up</i> 	Information and Control Mode	Level 1	Previous page from the left window
Button <i>To the right</i> 	Information and Control Mode	Levels 1 and 2	- To move the cursor one position to the right; - Next element (if any are available) from the left window
	SetUp Mode	Level 3A	To move the cursor one position to the right
Button <i>To the left</i> 	Information and Control Mode	Levels 1 and 2	- To move the cursor one position to the left; - Next element (if any are available) from the left window
	SetUp Mode	Level 3A	To move the cursor one position to the left
Button <i>Clear</i> 	Information and Control Mode	Levels 1 and 2	To delete a character pointed by the cursor (if no character is pointed, the first character to the left of the cursor will be deleted)
	SetUp Mode	Level 3A	
Buttons with digits, characters and symbols	Information and Control Mode	Levels 1 and 2	To insert a character/symbol to the left of the cursor
	SetUp Mode	Level 3A	

## 6.4. Addressing, initialization, re-initialization

### 6.4.1. Addressing

The method used for assigning addresses to addressable units in a fire alarm loop is called *Addressing*. The addressing can be automated or manual and shall be performed separately for each fire alarm loop.

In automated addressing the fire alarm loops' units obtain addresses according to a strictly specified algorithm and the fire control panel is capable to detect their location later. To be able to operate in automated addressing mode, a fire detector shall meet the following requirements:

- No short circuit or break up detected;
- Not more than one branch at a single point, i.e. between two consecutive units;
- No branches between the fire control panel and the first (the last) unit;
- No branching of branches.

In manual addressing the fire alarm loops' units obtain addresses as they are determined by the user. If, while performing manual addressing, the algorithm of the automated addressing is not followed, the fire control panel will not be capable to detect the units' location later. The only restriction in manual addressing is explained in section 6.4.2.3.

### 6.4.2. Initialization

Initialization is a process during which addresses are being assigned to addressable devices in a fire alarm loop. The initialization can be two types – clear initialization and standard initialization:

- In clear initialization new configuration of the addressable units is entered in the fire alarm loop
- In standard initialization the fire control panel checks the compliance of the addressable units' current configuration with the configuration, entered during the clear initialization.

In both types of initialization the switched-off addresses are skipped (in clear initialization of a fire alarm loop in manual addressing mode this shall be ensured by the user). The option allows reserving addresses for units, included later in the loop, without re-assigning the addresses of the current units.

#### 6.4.2.1. Clear initialization in automated addressing mode

Clear initialization is done in the following cases:

- Initial start-up of the fire control panel;
- The fire control panel or an output is being switched on at Set Up, when the default parameters of the control panel are entered;
- The function Clear initialization is being started at Set Up Mode – in such case it is performed only for fire alarm loops which are set to automated addressing.

The addressable units in the fire alarm line, detected by the control panel, are addressed in series (consecutively), and their parameters (identification number, type and class) are recorded in the fire control panel.

#### 6.4.2.2. Standard initialization in automated addressing mode

Standard initialization in automated addressing is done for fire alarm loops set to automate addressing, in the following cases:

- The fire control panel or an output is being switched on at Set Up, when the addressable units' configuration is registered in the control panel (i.e clear initialization has already been done);
- Start up of the Initialization function, at Set Up Mode (see section 13.7.1).

The location and the parameters (address, identification number, type and class) of the addressable units, detected in the fire alarm loop, are checked for compliance with these recorded in the fire control panel.

#### 6.4.2.3. Clear initialization in manual addressing mode

Clear initialization in manual addressing mode is performed during start up of the function Manual addressing, at Set Up (see 13.4.5); it is performed for a selected fire alarm loop only.

Any non-addressable units detected in the fire alarm loop obtain addresses previously determined by the user; their parameters (identification number, type and class) are recorded in the control panel. To ensure successful completion of the action, the fire control panel shall not have access to more than two units, located in any line of the loop; i.e. if more than one branch is available at a certain

point, units without addresses shall be available in two branches only (in the loop and in one branch, or in two branches).

#### 6.4.2.4. Standard initialization in manual addressing mode

Standard initialization in manual addressing mode shall be performed for fire alarm loops set to manual addressing, in the following cases:

- The fire control panel or an output is being switched on at Set Up, when the addressable units' configuration is registered in the control panel (i.e clear initialization has already been done);
- Start up of the Initialization function, in Set Up Mode (see section 13.7.1).

The parameters (address, identification number, type and class) of the addressable units, detected in the fire alarm loop, are checked for compliance with these recorded in the fire control panel. No check up of the units' location is done.

#### 6.4.3. Re-initialization

Re-initialization is an address recovery process for an addressable unit that has been removed from the loop and has been installed again. The re-initialization is performed in various ways, depending on the addressing type.

##### 6.4.3.1. Re-initialization in automated addressing mode

When replacing a removed addressable unit in a fire alarm loop, the fire control panel performs compliance check on unit's location and parameters (identification number, type and class) with these saved in the energy independent memory. A text message, *Re-initialization* is seen at the display's bottom part.

Depending on the result of the compliance check, the control panel performs the following actions:

- a) Where the control panel is capable to detect synonymously the location of the unit in the loop, and compliance of its parameters with these registered in the energy independent memory is detected, then:
  - ◆ The unit is started with its old address in the loop;
  - ◆ The fault *Removed device* is cleared;
- b) Where the control panel is capable to detect synonymously the location of the unit in the loop, but incompliance of its parameters with these registered in the energy independent memory is detected, then:
  - ◆ The unit is started with an address, equal to its location in the loop;
  - ◆ Fault condition for incompliance of identification number/type/class is activated;
  - ◆ The unit is included in the Service zone (see section 6.5);
- c) Where the control panel is not capable to detect synonymously the location of the unit in the loop (two or more serial units, that form an area, have been removed, but only some of them are installed again), then :
  - ◆ The unit is started with the first unoccupied address in the corresponding area of the loop;
  - ◆ Fault condition *Device not initialized* is activated
  - ◆ The unit is included in the Service zone.

When the last removed unit is replaced in the loop, the fire control panel will synonymously detect their location. For the last included unit the control panel will perform action a) or b). For the previously included units the control panel will perform the following actions:

- d) Where the control panel detects compliance of unit parameters with these saved in the energy independent memory:
  - ◆ The unit is started with its old address in the loop;
  - ◆ Fault conditions *Removed device* and *Device not initialized* are cleared;
  - ◆ The unit is excluded from the Service zone;
- e) Where the control panel detects incompliance of unit parameters with these saved in the energy independent memory:
  - ◆ The unit is started with an address, equal to its location in the loop;
  - ◆ Fault condition for incompliance of identification number/type/class is activated;
  - ◆ The unit remains in the Service zone.



#### 6.4.3.2. Re-initialization in manual addressing mode

When a removed addressable unit is replaced in the fire alarm loop, the fire control panel performs compliance check on the identification number of the replaced unit with the number saved in the energy independent memory, and starts up the unit with its old address.

#### 6.5. Operation of the fire control panel

Constructively, the fire control panel consists of two main PC boards – base PC board and loops PC board.

The base PC board is physically configured with 2 fire alarm loops, power loop, user's voltage, serial interface RS232, CAN1, CAN2, monitored and relayed outputs (Appendix 4).

Loops PC board is configured with 2 fire alarm loops and CAN1 (Appendix 4).

The two PC boards are factory connected via CAN1.

Two connected fire control panels are programmably simulated:

- base PC Board, named FireControlPanel LOCAL – as master fire control panel with address „1”;
- loops PC Board, named FireControlPanel Dist101 – as “slave” fire control panel with address „101”.

When IFS7002 is switched on, reset of the system devices and initialization of the addressable devices integrated in the loops are being done – addressable devices parameters (address, identification number, type and class) are being verified against these saved in the energy independent memory of the fire control panel. A text message *-System operations -* is displayed on the LCD.

Upon completion of the system operations the fire control panel enters operation mode – it monitors the addressable devices (automatic fire detectors, manual call points and executive devices) by consecutively scanning their condition. Simultaneously, a constant control over the loops, the monitored outputs and the voltage for fault conditions is being carried out.

The fire control panel IFS7002 operates in seven basic modes: Duty Mode, Fire Condition, Fault Condition, Disabled Component Mode, Test Mode, Information and Control Mode and SetUp:

- The fire control panel is in *Duty mode* when is not in any of the rest six modes (see section 7);
- The fire control panel enters *Fire condition* when a fire detector is activated in any zone (see section 8);
- The fire control panel enters *Fault condition* when a fault is registered (see section 9);
- The fire control panel enters *Disabled component* after manual operation, disabling a certain components has been performed – fire alarm zone, addressable unit or controllable output (see section 10);
- The fire control panel enters *Test mode* after a manual operation, setting the zone in test (see section 11);
- The fire control panel enters *Information and Control Mode* when the main menu is activated in Duty mode, Fire condition, Fault condition (without fatal error), Test condition and Disabled component (see section 12);
- The fire control panel enters SetUp Mode after activation of submenu Set up, in Information and Control Mode (see section 13);

In any moment the fire control panel can be in any of the above conditions/modes, or in a random combination of Fire condition, Fault condition, Disabled component, Test mode and Information and Control mode.

Duty Mode and SetUp Mode can not be combined with another mode:

- the fire control panel enters Duty Mode after all other conditions are exited;
- when the fire control panel enters SetUp Mode it exits all other conditions.

Up to 500 fire alarm zones can be formed in IFS7002. Except for these zones the fire control panel supports two additional zones for each PC board:

- Service zone (Zone 0) – here addressable devices which location in the loop can not be detected synonymously are integrated;
- Zone 255 – here addressable devices not included or that can not be included in a fire alarm zone (addressable output and input devices) are integrated.

In Fire condition the relay output for fire condition is always activated („Rel Fire”). Also, the outputs (relay, controllable and addressable) associated to a corresponding phase of the fire condition for the

zone in fire, are activated. These outputs can be suppressed and then again activated by manual operation at Access level 2 (see section 8.3.4.2).

The number of activated addressable units' inputs, associated to fire alarm loop is seen on the control panel's display, in the middle of the bottom line. The inputs can be programmed to display text messages and/or to activate addressable outputs. The text messages generated by the activated inputs can be reviewed via the menus of Information and Control Mode (see section 12.2.4). Addressable outputs, activated by inputs, are in operation only when the fire condition is in Fire condition. However they can not be manually suppressed.

When a removed addressable unit is replaced in a loop, the fire control panel re-initializes it. When an automated addressing is set for a certain loop, and the re-initialization is not successful due to reasons explained in b), c) and e), 6.4.3.1, the following actions can be performed:

- If units have been involuntarily exchanged, they shall be placed on their proper location;
- The unit shall be excluded from the Service zone, via Menu "Re-addressation" (see section 13.7.3) and the suitable address shall be assigned;
- The new loop configuration shall be saved through Function "Clear Initialization" (see section 13.7.2).

When new addressable unit is included in a loop set to automate addressing, (exceeding the total number of addressable units in the loop), the fire control panel assigns a temporary address (message seen in the bottom part of the display - *Re-initialization*), but ignores it in its operation. To add the unit to the loop configuration the function Clear Initialization shall be activated (see section 13.7.2).

When new addressable unit is added to a loop set to manual addressing, the fire control panel ignores it in its operation. To add the unit to the loop configuration the Function Manual Addressation shall be activated (see section 13.4.5).

When the fire control panel is in Fire condition or in Fault condition or in a combination of one of these, the lighting of the display is constantly on, until you press button *Stop alarm*  (with the exception of these fault conditions – *Battery low*, discharged batteries due to interruption of mains supply, and *Fault in mains supply*). Upon *Battery low* the lighting of the display is constantly off. In all other cases the lighting is extinguished 3 min after the last pressing of any button on the display.

## 7. Duty Mode

### 7.1. Description

The fire control panel is in Duty Mode, when it is not in any other of the rest 6 possible conditions.

### 7.2. Indication

#### 7.2.1. LED and sound indication

In Duty Mode the green LED indicator is activated  (Power supply). The local sounder is off.

#### 7.2.2. Text message

The display shows the logo of the company-producer, information on the current local time and the mode of operation of the fire control panel (DAY or NIGHT), the mode of control (Loc – control of local panel, or RemX – control of a remote panel, where X is the panel's address:

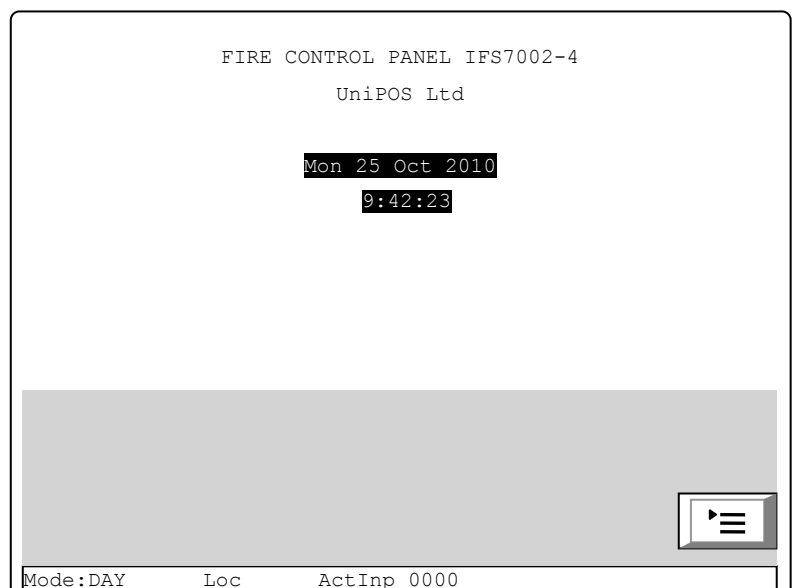

7.3. Using the keypad

The only accessible button in Duty Mode is  (Menu). Press it and the fire control panel enters Information and Control Mode.

**8. Fire condition**

8.1. Description

The fire control panel enters Fire Condition after a fire detector has been activated in one of the fire alarm zones. In Mode:DAY the condition has two phases – *Fire condition stage I* and *Fire condition stage II*. The time period for *Fire condition stage I* is limited and is user programmable, separately for each zone (up to 255 seconds). The period can be prolonged with the Inspection time (see section 8.3.1). When *Fire condition stage I* in this particular zone expires, the fire control panel enters *Fire condition stage II* in the same zone.

The fire control panel enters *Fire condition stage I* upon activation of an automatic fire detector and *Fire condition stage II* - upon activation of a manual call point.

In Night Mode the phase *Fire condition stage I* is ignored. The fire control panel enters Fire condition, phase *Fire condition stage II* upon activation of a manual call point or of an automatic fire detector.

The fire control panel can be in Fire Condition in one or more zones. In the second case, when in Mode:DAY, the fire control panel can be in phase *Fire condition stage I* in part of the zones, and in phase *Fire condition stage II* in the rest of the zones.

In Fire condition the relay output “Rel Fire” is activated. The outputs (relay, controllable and addressable) associated to a corresponding phase of the Fire condition for the zones in fire, are also activated.

To exit this condition press button  at Access level 2 (see section 8.3.5).

8.2. Indication

8.2.1. LED and sound indication

In this condition the common light indicator illuminates in red flashing light  (Fire condition).

The local sounder produces discontinuous signal (0,5s sound, 0,5s break), if the device has not been suppressed by button  (Stop Alarm).

8.2.2. Text messages

Information on zones for which the fire control panel has detected Fire condition is displayed:

For this condition the display is divided into three panels.

The first panel (the upper one) displays information on zones and on the fire control panel in fire condition. A flashing heading with the text FIRE and the total number of zones in fire condition appear. The panel is subdivided into two text fields, each providing two lines. The first line displays information on the first zone and the fire control panel in fire condition, the second line provides information on the last zone and the fire control panel in fire condition.

The first line of each field provides information on the type of the fire condition:

- the sequence number of the indicated fire condition;
- the phase of Fire condition detected by the fire control panel in this particular zone;

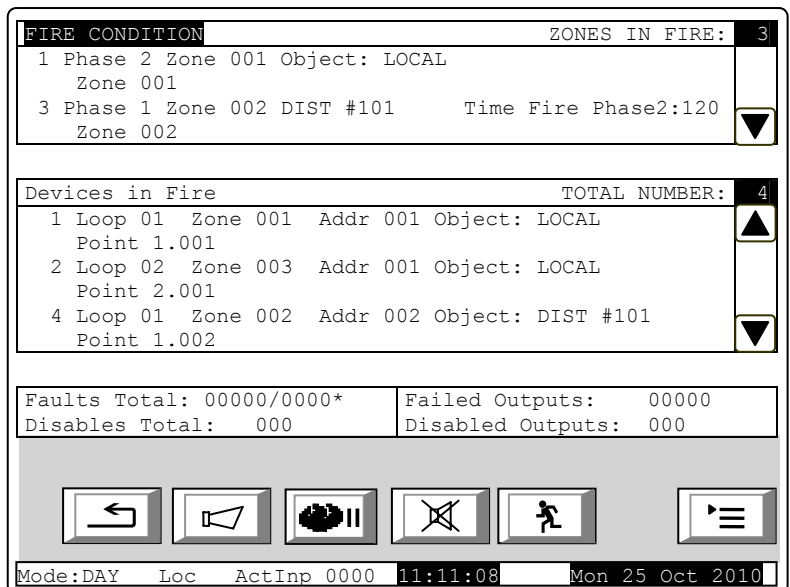

- the zone number;
- the fire control panel that is in Fire condition (Local or remote control panel). After the remote panel its address is also displayed;
- the remaining time in seconds before the fire control panel proceeds to phase *Fire condition stage II* (indicated only in *Fire condition stage I*).

The second line of each field displays a text message for the corresponding zone. If the fire control panel has entered Fire condition in more than two zones, the rest of the text messages for fire condition are suppressed. They can be displayed in the upper field by pressing the buttons on the right side (see section 8.3.6.1).

The second panel (the middle one) provides information on devices in fire condition. In the head part is displayed the total number of devices in fire condition. The panel itself is subdivided into three text fields, each providing two lines. The upper two-line field displays information on the first device that has detected fire condition; the middle two-line field displays information on the second device in fire condition, the bottom two-line field – information on the last device.

The first line of each field provides information on the device:

- the sequence number of the device in fire condition;
- the fire alarm loop where the device is integrated into;
- the zone number;
- the device address in the fire alarm loop;
- the fire control panel that is in Fire condition (Local or remote control panel). After the remote panel its address is also displayed;

The second line of each field displays text messages relevant to this particular device.

If more than three devices are activated due to fire condition, the rest of the messages are suppressed. However, they can be displayed in the upper fields, by pressing the buttons on the right side (see section 8.3.6.2).

The third panel (the bottom one) displays information on the numbers of faults and disables – total number and for the outputs (monitored outputs and addressable output devices).

### 8.3. Using the keypad

#### 8.3.1. Button (Inspection)

The button appears on the display when the fire control panel enters phase *Fire condition stage I* in a new zone; it is extinguished if pressed or if all zones in Fire condition proceed to phase *Fire condition stage II*.

When you press the Inspection button, the remaining time for the zones in *Fire condition stage I* after which they proceed to *Fire condition stage II*, is prolonged with user programmed inspection time for each particular zone. The operation can be performed only once for each zone in *Fire condition stage I*, i.e. it is executed for zones where the remaining time has not already been prolonged with inspection time.

#### 8.3.2. Button (Stop Alarm)

The button appears on the display when the fire control panel enters Fire condition in a new zone or upon registration of a new fault condition; it is extinguished if pressed or if the local sound signaling is suspended (fault conditions suspended and/or the fire control panel exits Fire condition).

Press it to turn off the local sounder.

Button's operation does not effect and is not cancelled by the following events:

- When the fire control panel enters Fire condition in a new zone or proceeds from *Fire condition stage I* to *Fire condition stage II*, the local sounder is activated for Fire condition only.
- A new fault condition will trigger the local sounder for Fault condition only.

#### 8.3.3. Button (Fire condition stage II)

The button is seen on the display when the control panel in Fire condition and there are zones in Fire condition stage I.

Press the button to force transition from Fire condition stage I to Fire condition stage II.



#### 8.3.4. Button (Outputs)

The button is seen on the display when the control panel is in Fire condition; the button is provided to suppress and enable activation of outputs for fire condition at Access level 2. Addressable outputs, activated by the inputs, can not be suppressed.

The button does not affect and is not influenced by the following events: Fire condition in new zone or transition from phase Fire condition stage I to Fire condition stage II will trigger the outputs for fire condition, associated to this zone for a certain fire stage; if any outputs for fire condition are suppressed, the button will have the following graphic: .

8.3.4.1. Access Level 1

Press the button at Access level 1 to display a screen where the password is entered:

To enter a password use the buttons with digits – press a digit and it appears on the place of the cursor, and the previous text and the cursor itself move one position to the right. Move the cursor to the left or to the right, using buttons  and .

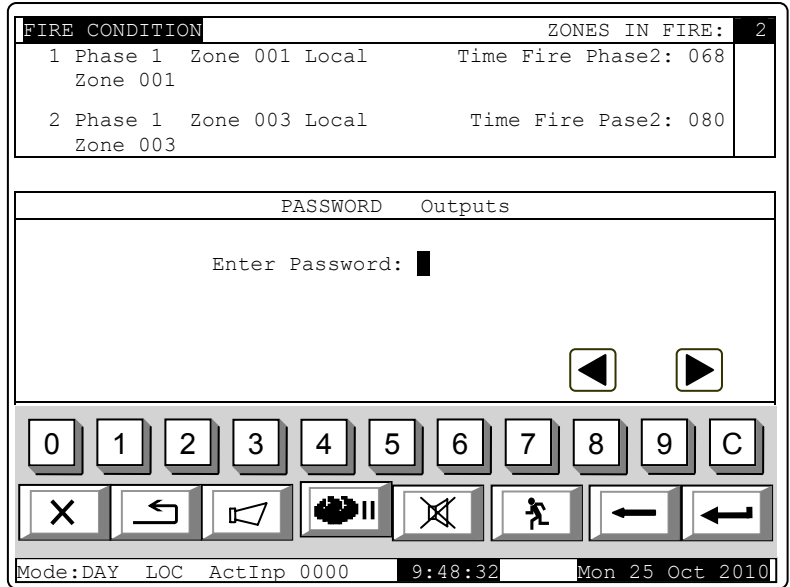



Button  will delete:

- Any digit under the cursor;
- Or, if there is no digit under the cursor, then will be deleted the first digit to the left.

The length of the password can be 10 symbols maximum. If you press a digit button when the 10-symbol password is entered, the digit will not be inserted.

The operation of button  is:

- If a wrong password is entered – the entered digits will be deleted and the cursor will appear over the password’s first position;
- If one of the 10 passwords for Access Level 2 or the password for Access Level 3 is entered:
  - ◆ Where activated outputs for fire condition are available – these outputs will be suppressed;
  - ◆ Where activated outputs for fire condition are not available – the suppressed outputs will be activated;
  - ◆ The fire control panel will exit Information and Control Mode, if it has been operating in a combination of Fire condition mode and Information and Control Mode.

To exit the screen press buttons  (Exit) or  (Cancel). Then, if the fire control panel had been in a combination of Fire condition and Information and Control Mode, it would exit Information and Control Mode.

8.3.4.2. Access Level 2

Press button  at Access Level 2 to:



- Where activated outputs for fire condition are available – these outputs will be suppressed;
- Where activated outputs for fire condition are not available – the suppressed outputs will be activated
- Exit Information and Control Mode.

8.3.5. Button  (“Reset of fire condition”)

The button is seen on the display when the fire control panel is in Fire condition and can be used to force the fire control panel to exit Fire condition at Access Level 2.

### 8.3.5.1. Access Level 1

Press the button at Access Level 1 to display a screen for password entering

Enter the password using the buttons with figures, replacing the cursor position „█“, and the previously entered text and the cursor itself move one position to the right. Use buttons  and  to move the cursor to the left or to the right.



When pressed, button  will delete:

- Any figure under the cursor;
- The figure at the left of the cursor, when no figure is entered under it.

Password's maximum length is 10 symbols. When a password with such length has been already entered, no more figures will be accepted.

Button  has the following effect:

- If the password is not the correct one – the entered figures will be deleted and the cursor will move to the first position;
- If one of the 10 passwords for Access Level 2 is entered, or a password for Access Level 3:
  - ◆ The fire control panel will exit the Fire condition;
  - ◆ The fire control panel will exit Information and Control Mode if it was in a combination of Fire condition and Information and Control Mode.

To exit the screen, press buttons  (*Escape*) or  (*Cancel*). If the fire control panel has been operating in a combination of Fire condition mode and Information and Control Mode, it will exit Information and Control Mode

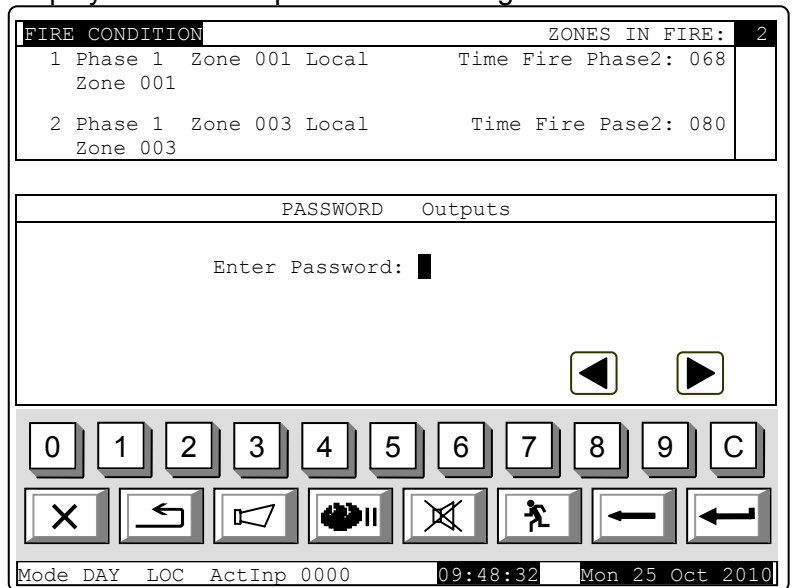





### 8.3.5.2. Access Level 2



Press button  at Access Level 2 to exit Fire condition and Information and Control Mode.

### 8.3.6. Buttons (*Move down*) and (*Move up*)

#### 8.3.6.1. Panel for zones in fire condition

Where suppressed messages for zones in fire condition are available they can be displayed in the text fields of the first (upper) panel on the LCD display, by the means of buttons  and  situated in the panel's right section.



Button  appears on the display where a message for a zone in Fire condition following the message in the first text field is suppressed. Press the button to display it. When the last suppressed text message for a zone in Fire condition is reached, the button  disappears.



Button  appears on the display where a message for a zone in Fire condition preceding the message in the first text field is suppressed. Press the button to display it. When the first suppressed text message for a zone in Fire condition is reached, the button  disappears.



If a suppressed message for a zone in Fire condition is displayed, 20 s after the last button is pressed, the message for the first zone in fire condition will be automatically restored.



### 8.3.6.2. Panel for devices in Fire condition

Where suppressed messages for devices in Fire condition are available, they are displayed in the two text fields of the second (middle) panel, by the meansp of buttons  and  situated in the right part of the panel.

Button  is activated if the numbers of the messages in the second and the third field are not consecutive. When you press the button  you will display the consecutive messages for devices in Fire condition, in the first and second text fields.

Button  is activated if the number of the message in the first text field is higher than 1. When you press the button  you will display the previous messages for devices in Fire condition, in the first and second text fields of the middle panel.

### 8.3.7. Button (*Menu*)

Press the button to enter Information and Control Mode; the mode uses the middle and the bottom panel of the screen for Fire condition.

### 8.3.8. Button (*Exit*)

When Fire condition is in combination with Information and Control Mode, press the button and the fire control panel exits Information and Control Mode and on the display appear all three panels of the screen for Fire condition.

## 9. Fault Condition

### 9.1. Description

The fire control panel enters Fault Condition when any of the events below have been registered:

- Fatal system error;
- Battery low – backup batteries discharged due to interruption of mains supply;
- Fault in a processor programme;
- Fault in a module;
- Fault in the real time clock;
- Fault in the external memory;
- Fault in a loop – a short circuit or a break;
- Loop not initialized;
- Higher number of devices in the fire alarm loop;
- Fault in a zone – upon detection of fault condition in a device, integrated in the zone;
- Removed device;
- Fault condition in a device;
- Activated isolator of a device;
- Activated isolator at the Power loop of a device;
- Contaminated fire detector (for optical detectors);
- Communication error
- Device not initialized (detected new device in a loop);
- Exchanged devices;
- Different identification number of a device,
- Different device type;
- Different device class;
- Fault in a monitored output – short circuit or break;
- Fault in the mains supply;
- Fault in the backup batteries supply;
- Short circuited ground wire;
- Fault in the positive supply of the loops;
- Fault in the negative supply of the loops;
- Fault in external devices supply;
- Fault condition in communication with a remote fire control panel;
- Fault condition in the remote fire control panel.

Where a fatal system error occurs, the main processor can not continue operation and the fire control panel does not control loops, outputs and other periphery devices. To exit fatal system error you have to cut off the mains supply and to repair the control panel.

*Battery Low* is a fatal non-system error; zones and outputs are not being services. The fire control panel enters a special condition:

- A discontinuous sound signal is produced - 1s sound, 3s break for at least 1 hour;
- Only the green LED indicator is illuminated  (*Power supply*).
- The lighting of the display is extinguished;
- Only the supply voltages are controlled.

The condition is exited automatically 20 s after the mains supply is restored.

All other fault conditions are not fatal and switch off some periphery devices. The condition is exited automatically 20 s after the fault is suspended.

Upon fault condition *Short circuit to ground wire* where an element of a monitored output is short circuited, fault condition in the monitored output (break) is also developed.

Fault condition is indicated by LEDs indicators and a text message on the LCD display.



## 9.2. Indication

### 9.2.1. LED and sound indication

Where fatal system errors occur the indicators  (Fault condition) and  (System error) illuminate in continuous yellow light. The local sounder produces continuous signal.

Upon *Low battery* fault condition no LED indicator is illuminated. The local sounder produces discontinuous signal (1 s sound, followed by 3 s break). The lighting of the LCD display is off.

All other fault conditions are designated by indicator  (Fault condition), illuminating in continuous yellow light. Depending on the specific fault, the following indicators are illuminated too:

- Upon *System error* - indicator  (System error) in continuous yellow light;
- Upon *Fault in mains supply* - indicator  (Fault in mains supply) in continuous yellow light.

The local sounder produces discontinuous signal (1s sound, 1s break), if not previously suppressed by  (*Stop Alarm*) button.

### 9.2.2. Text messages

Upon fatal system errors the following information screen is displayed (the first line of the text messages is information intended for the service staff):

The screen suppresses all other text indications and can not be suppressed.

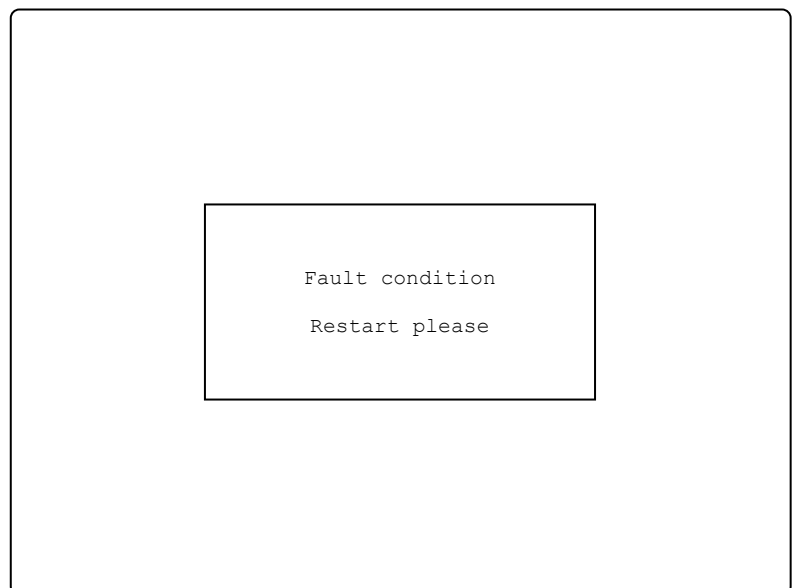



Upon *Battery Low* condition - full discharge of the backup batteries due to interrupted power supply – the following information screen appears:

The screen suppresses all other text indications, with the exception of *System error* message, and can not be suppressed.

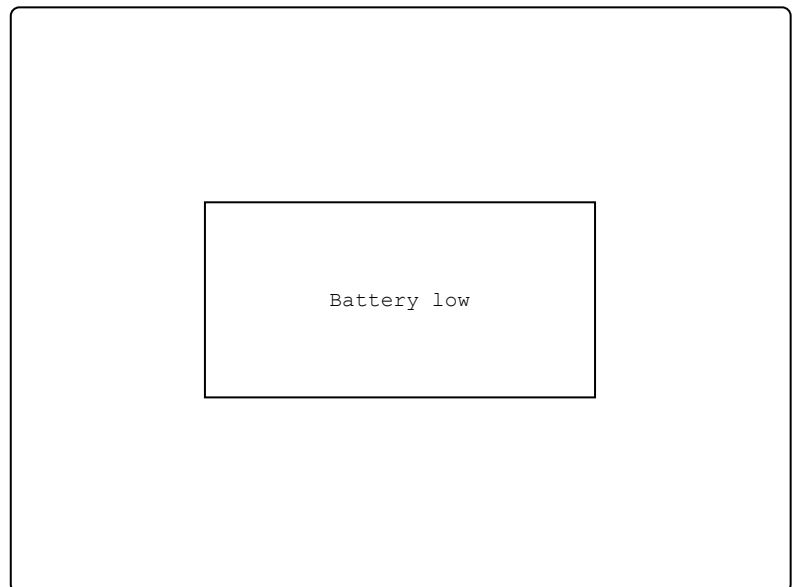

For all other fault conditions a table, containing information on the number of fault events and the number of disabled devices is displayed. The first line of the tables' left column displays the total number of fault conditions; the first line of the table's right column displays only the number of faults in outputs (monitored outputs and addressable output devices):

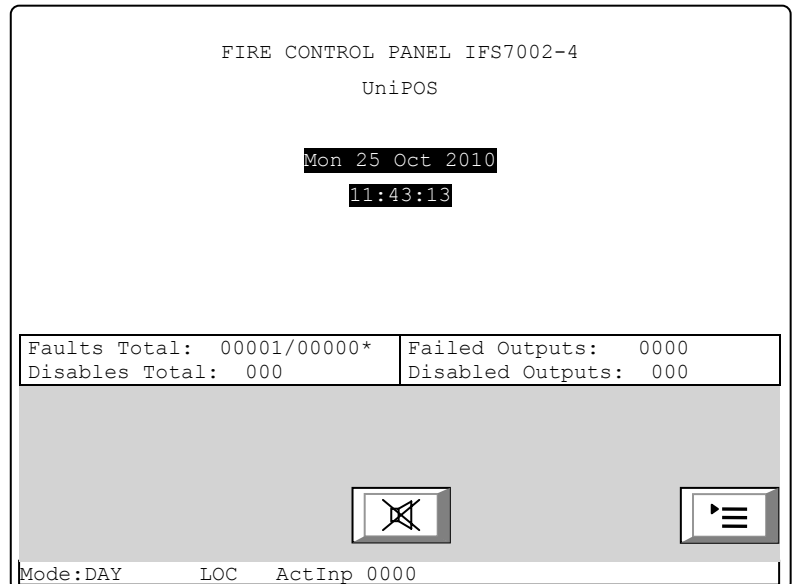

To display the text message for each fault condition, enter Information and Control Mode (see section 12.2.1).

### 9.3. Using the keypad

None of the buttons is active upon fatal fault condition. For all other fault condition 2 buttons are being supported. Where the fire control panel operates in combination of other conditions, their buttons are active too.

#### 9.3.1. Button (Stop Alarm)

The button appears on the LCD display where the fire control panel enters fire condition in a new zone or a new fault condition occurs; it disappears if pressed or if the sound signaling is suspended (fault conditions suspended and/or fire control panel exited fire condition)

Press the button to switch the local sounder off.

The button does not affect and is not influenced by the following events:

- Fire condition in new zone or transition from phase *Fire condition stage I* to *Fire condition stage II* will trigger the local sounder and a signal for fire condition only will be produced;
- New fault condition will trigger the local sounder and a signal for fault condition only will be produced.

#### 9.3.2. Button (Menu)

Press the button to enter Information and Control Mode.

## 10. Disabled component

### 10.1. Description

The fire control panel enters *Disabled component* after a manual operation, disabling a specific component – a fire alarm zone, addressable device or monitored output. The condition is handled via Information and Control screens (see section 12.3.1). A disabled zone is not monitored for activated fire detectors or fault condition. A disabled addressable device is not activated (if it is an executive device) and is not monitored for activation (if it is a fire detector) or fault condition. A disabled monitored output is switched off (the executive device is not able to respond) and is not monitored for fault condition.

Where disabled zones, disabled addressable devices or disabled monitored outputs are available, the LED indication illuminates and the relevant message is displayed

### 10.2. Indication

#### 10.2.1. LED and sound indication

The condition is indicated by the Common indicator  (Disabled component) illuminated in continuous yellow light.

No sound signaling is supported for *Disabled component* condition.

#### 10.2.2. Text messages

If a disabled component is available, a table giving information on the total number of disabled devices and faults appears on the LCD display. The second line of the table's left column displays the total number of disabled components; the second line of the table's right column – only the number of disabled outputs (monitored outputs and addressable output devices):

FIRE CONTROL PANEL IFS7002-4			
UniPOS			
Mon 25 Oct 2010			
11:48:24			
Faults Total:	00000/00000*	Failed Outputs:	00000
Disables Total:	002	Disabled Outputs:	001
			
Mode:DAY    LOC    ActInp 0000			

To display the text message for each fault condition, enter Information and Control Mode (see section 12.2.2).

### 10.3. Using the keypad

For *Disabled component* condition 1 active button is supported. Where the fire control panel operates in combination of other conditions, their buttons are active too.

Press button  (Menu) to enter Information and Control Mode.

## 11. Test Mode

### 11.1. Description

The fire control panel enters Test Mode through manual operation setting a fire alarm zone to Test Mode. The condition is handled via Information and Control Screens (see section 12.3.2).

Where a fire alarm zone is set to Test Mode, the following changes take effect:

- Where *Fire condition stage I* or *Fire condition stage II* is detected in the zone, sound and LEDs indications, associated addressable, controllable or relay outputs are not triggered; i.e. the fire control panel does not enter Fire Condition;
- Where Fault condition in a zone is registered, (i.e. fault in any device, integrated in the zone), sound and LEDs indications or the relay output for fault condition are not triggered, i.e. the fire control panel does not enter Fault Condition (with the exception of the isolator of a device in

the zone, because it would break the integrity of the loop; in this case a fault in the device would be registered, but not fault in the zone);

- Occurred events (with the exception of triggered isolator in the zone) are not saved in the energy independent memory;
- The zone is being automatically reset every 60 s (detectors in fire condition receive a command to reset the fire)

## 11.2. Indicators

### 11.2.1. LEDs and sound indicators

The common indicator for Test Condition  (*Test*) illuminates in continuous yellow light. Sound signaling is not supported for this condition.

### 11.2.2. Text messages

To display the text messages for fire alarm zones in test condition enter Information and Control Mode (see section 12.2.3).

## 11.3. Using the keypad

For Test Condition 1 active button is supported. Where the fire control panel operates in combination of other conditions, their buttons are active too.

Press the Menu button  to enter Information and Control Mode.





## 12. Information and Control Mode









### 12.1. Description

Information and Control Mode provides the user with the possibilities to display information associated with the fire control panel, and to enter control data.

To enter Information and Control Mode, press button  on the screen for Duty Mode, Fire Condition, Fault Condition (with the exception of the screen for fatal error), Test Mode or Disabled component.

No specific LEDs or sound indication is provided for Information and Control Mode.

Where the fire control panel operates in combination of Information and Control Mode and Fault Condition, button  (Stop Alarm) is active too. Where the fire control panel operates in combination of Information and Control Mode and Fire Condition, buttons  (Stop Alarm),  (Outputs) and  (Inspection) are active; and at Access Level 2 is active button  (Reset Fire).

The screens visualized on the display are organized in a tree structure, containing subordinate menus (Appendix 2a). Transition to a lower hierarchy menu is performed by the means of button  (Enter); to revert to an upper hierarchy menu use button  (Cancel). To switch between elements of one menu use buttons  (Up) and  (Down), when the menu is displayed as an ascending window from the bottom left corner of the screen, or use buttons  (Move Up) and  (Move Down), when the menu is displayed as a panel in the middle of the screen. To exit the condition press button  (Exit) or button  (Cancel) until you exit the main menu.

When you enter Information and Control Mode, transition to the first menu is being carried out. The first menu contains three subordinate menus, requiring separate access levels:

- Lists – Access Level 1;
- System functions – Access Level 2;
- SetUp – Access Level 3.

## 12.2. Menu Lists

The menu displays detailed information associated to the current state of the fire control panel and the addressable devices, as well as for the configuration and the setup of the control panel.

Menu *Lists* contains the following subordinate menus and information screens;

- Menu *Faults*;
- Menu *Disables*;
- Menu *Tests*;
- Menu *Input messages*;
- Menu *Activated outputs*;
- Screen *Panel configuration*;
- Menu *Panel parameters*;
- Menu *Loops*;
- Menu *Zones*;
- Menu *Devices status*;
- Menu *Inputs*;
- Menu *Archive*;
- Menu *Select Loc/Rem control panel*.

### 12.2.1. Menu *Faults*

Use the menu to display detailed information for faults in the fire control panel and in addressable devices.

Menu *Faults* contains the following subordinate menus:

- Menu *Total* – displays information for all fault conditions;
- Menu *Zones* – displays information only for zones in fault condition;
- Menu *Devices* – displays information only for devices in fault condition;
- Menu *Outputs* – displays information only for outputs in fault condition (monitored outputs and addressable output devices);
- Menu „LAN objects” – to display information for remote control panels (Appendix Interactive Fire Control Panel IFS7002 – Local Network Operation).

The four subordinate menus have identical layout. If no faults are detected (or no faults of a specific type are detected) the following screen appears:

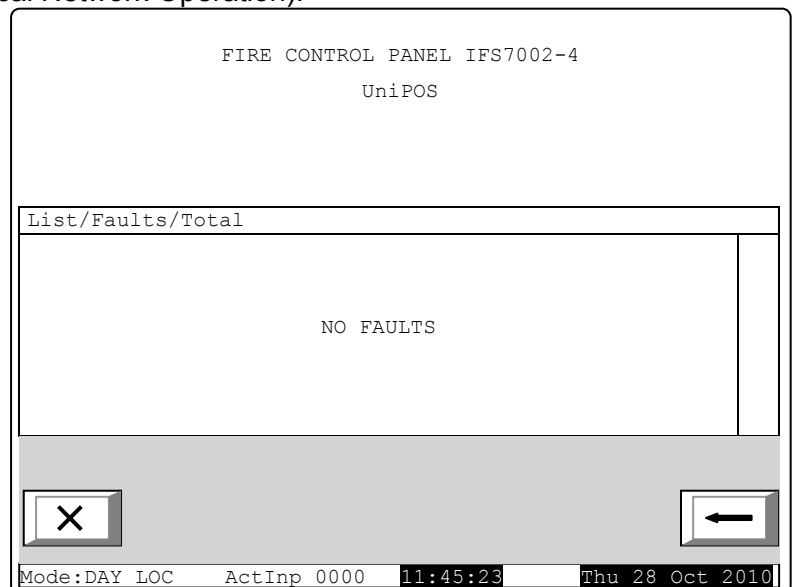



If faults are detected, the following screen appears:

Each message can be displayed in a few lines – from 1 to 4. It brings out the following information

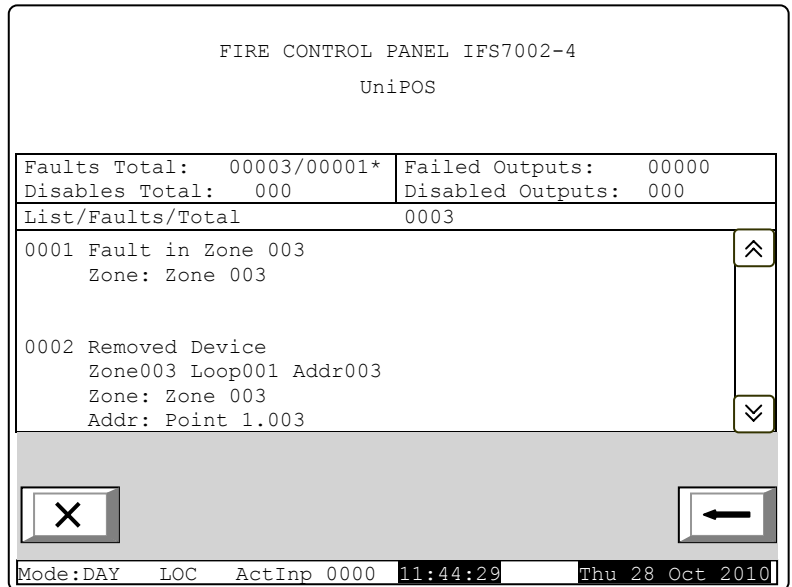
- Text for the type of the fault – this information is mandatory;
- Information for the device (zone – if the device is fire detector, loop and address) – in case the fault condition is in an addressable device;
- Text message for the zone – visualized if the fault condition is in an addressable fire detector;
- Text message for the device – visualized if the fault condition is in an addressable device.



Buttons  and  situated in the right panel section scroll the pages up and down – next page or previous page (if any are available). One page contains two messages for fault condition.

12.2.2. Menu *Disables*

The menu displays detailed information for disabled zones, disabled addressable devices and monitored outputs of the fire control panel.

Menu *Disables* contains the following subordinate menus and screens:

- Screen *Total* – displays information for all disables;
- Menu *Zones* – displays information only for disabled zones;
- Menu *Devices* – displays information only for disabled addressable fire detectors;
- Menu *Outputs* – display information only for disabled outputs (monitored outputs and addressable output devices).

12.2.2.1. Screen *Total*

If no disables are set, the following screen appears:

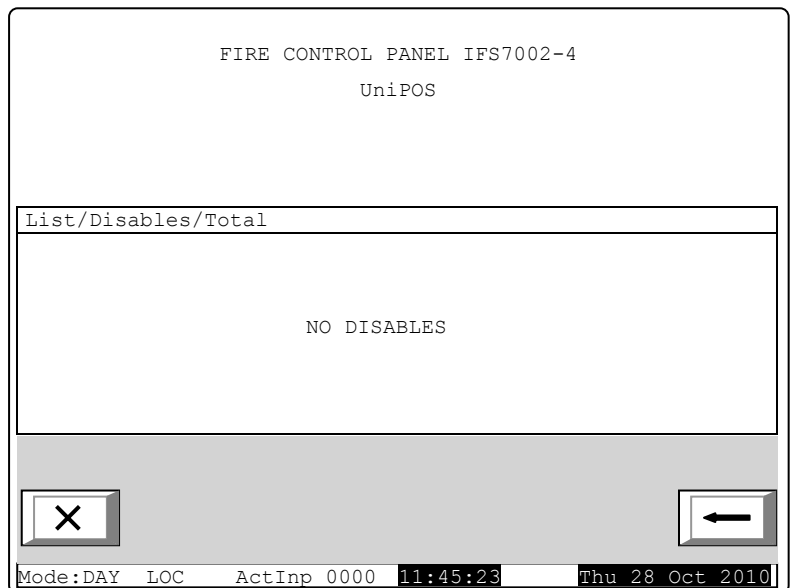

Screen *Total* has the following layout:

It brings information out for:

- Total number of disables;
- Number of disabled zones;
- Number of disabled detectors;
- Number of disabled outputs (monitored outputs and addressable output devices).

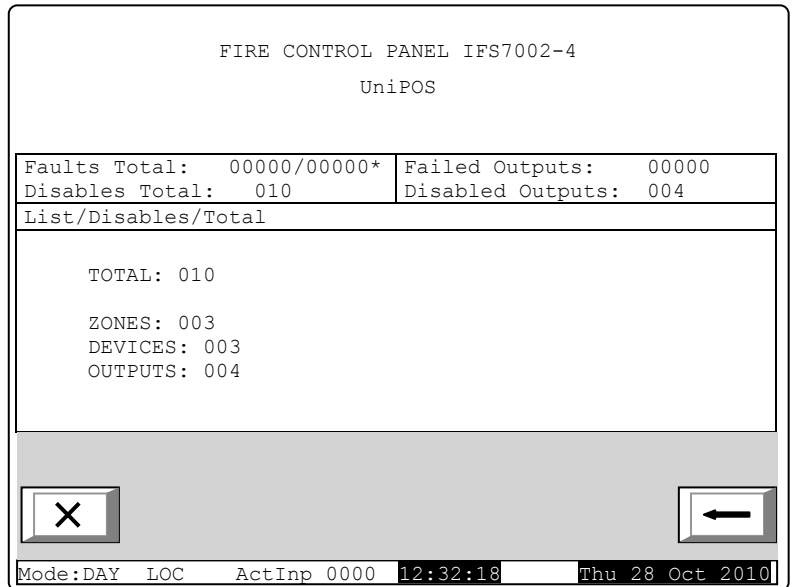

#### 12.2.2.2. Menu *Zones, Devices and Outputs*

The three subordinate menus have identical layout. If disables of certain type are not available, the following screen appears:

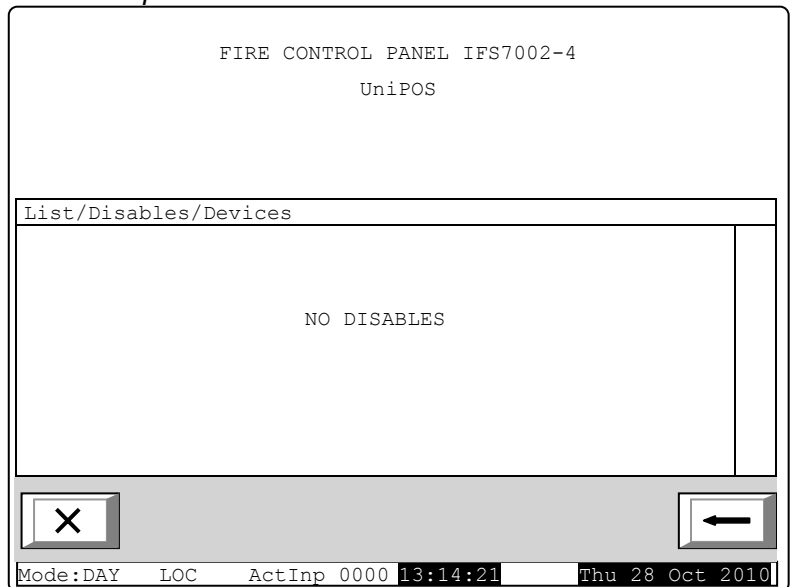

If disables are available, the screen is:

Each message is displayed in two lines.

Menu *Zones* displays:

- The zone number;
- Text message for the zone.





Menu *Devices* displays:

- Information for the device – loop, address and zone;
- Text message for the device.

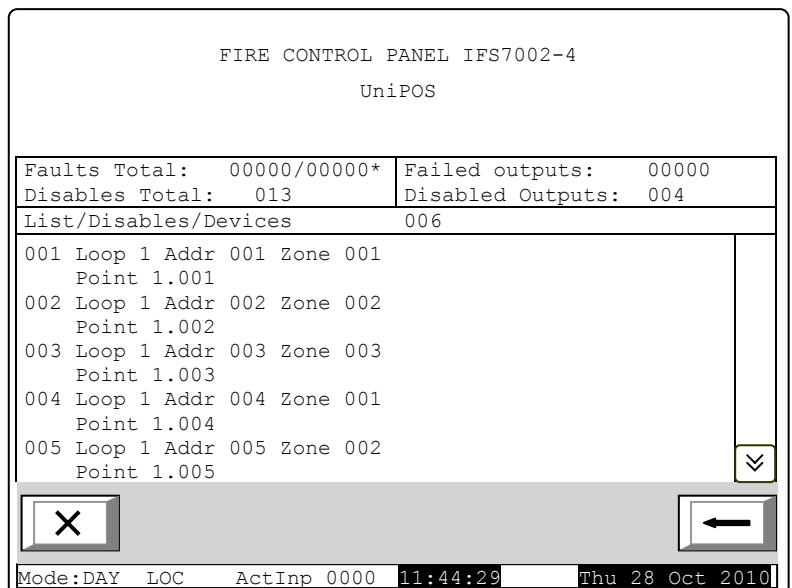
Menu *Outputs* displays:

- Information for the device
  - ◆ For monitored outputs – number of the monitored output;
  - ◆ For addressable output devices – loop and address;
- Text message for the device – for addressable output devices only.



Buttons  and  situated in the right panel section scroll the pages up and down and allow displaying next page or previous page. Each page contains 5 messages for disables. Button  appears on the screen if next page is available; button  appears on the screen if previous page is available.

### 12.2.3. Menu *Zones in Test*

The menu provides detailed information for zones set to Test Mode.

Menu *Zones in Test* contains the following subordinate menus:

- Menu *Zones* – brings out information for zones set to Test Mode;
- Меню *Zone Status* – brings out information for the status of zones set to Test Mode.

#### 12.2.3.1. Menu *Zones*



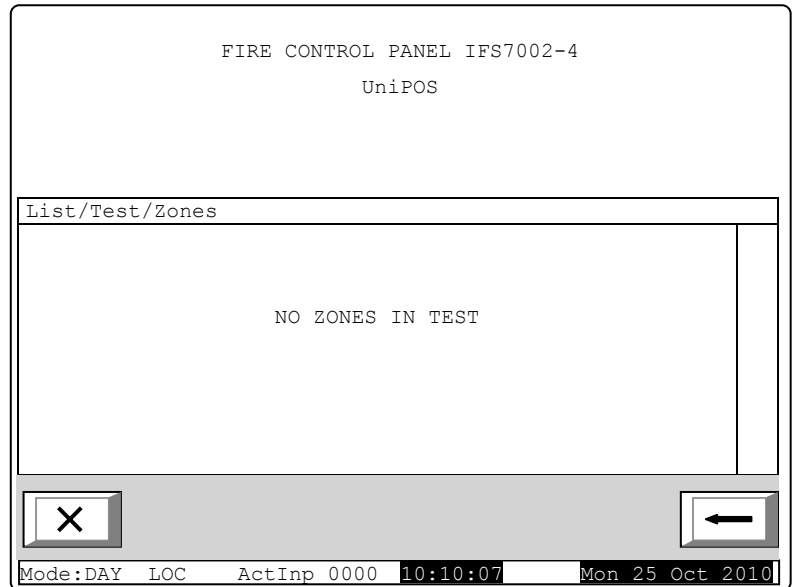

If no zones are set to Test Mode the following screen appears:



Where zones set to Test Mode are available, the following screen appears:

The displayed information is for

- Zone number;
- Text message for the zone

Buttons  and  in the right panel section scroll the pages up and down and allow displaying next page or previous page. Each page contains 5 messages for zones in Test Mode. Button  appears on the screen if following page is available; button  appears on the screen if previous page is available.

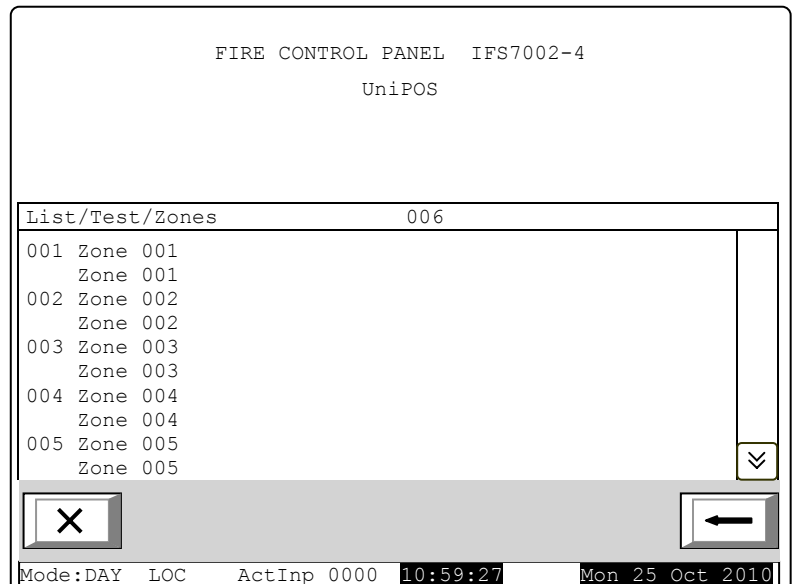

12.2.3.2. Zone Status

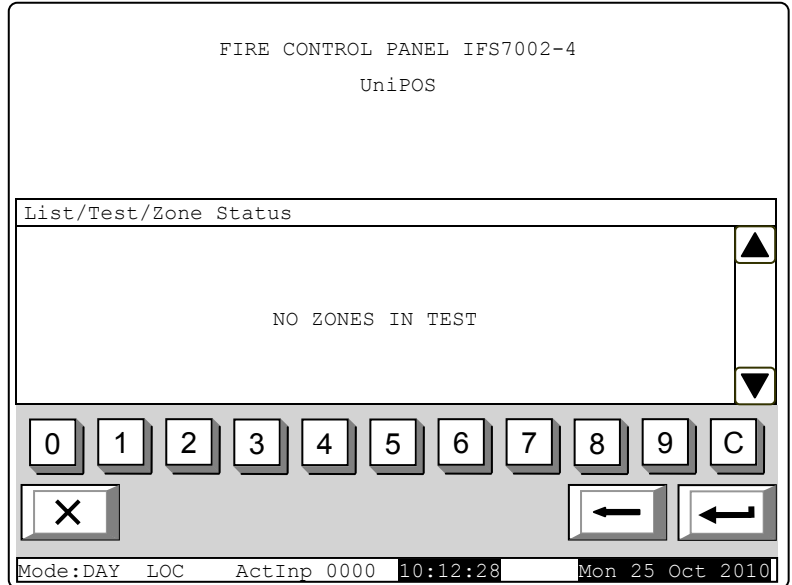

If no disables of specific type are available the following screen appears:





If disables are available the status of the first zone in Test Mode is displayed:

Each message is displayed in two lines, under the *Status* text message:

- The first line displays zone number and status;
- The line beneath displays text message for the zone.

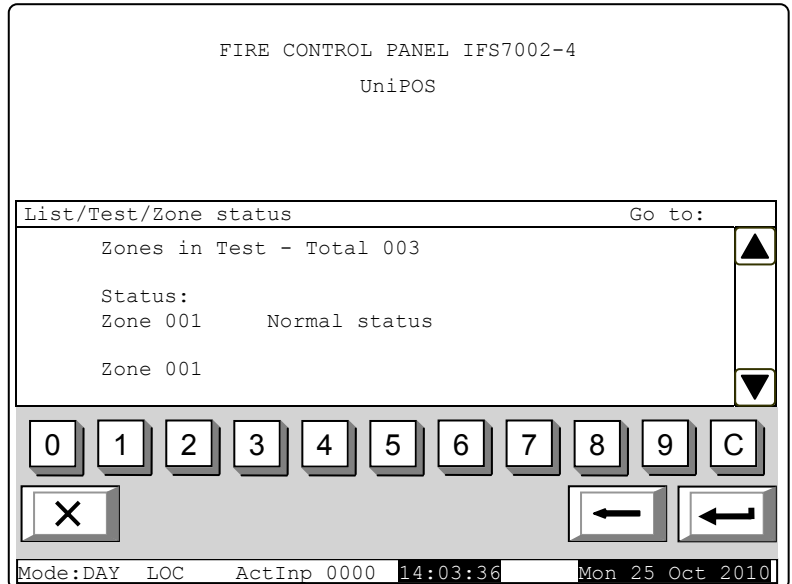
Buttons  and  in the right panel section allow the user to display the status of the next or the previous zone (if any are available) in Test Mode.



Press a button with figure and the field *Go to* situated on the heading of the panel is activated, and you can enter a random 3-digit number of the zone. To correct the number use button ; the button deletes the last digit you entered.

As soon as you enter a number in the field *Go to*, press button  to display the status of the specified zone:

- If you select zone number 0, the status of Zone 1 will be displayed;
- If you select zone number higher than 250, the status of Zone 250 will be displayed;
- If the selected zone is not set to Test Mode, a text message NOT IN TEST appears; the text message for the zone is not displayed;
- The number in the *Go to* field is deleted, i.e. the field is deactivated.



#### 12.2.4. Menu *Input messages*

The menu displays messages sent by activated addressable input devices.

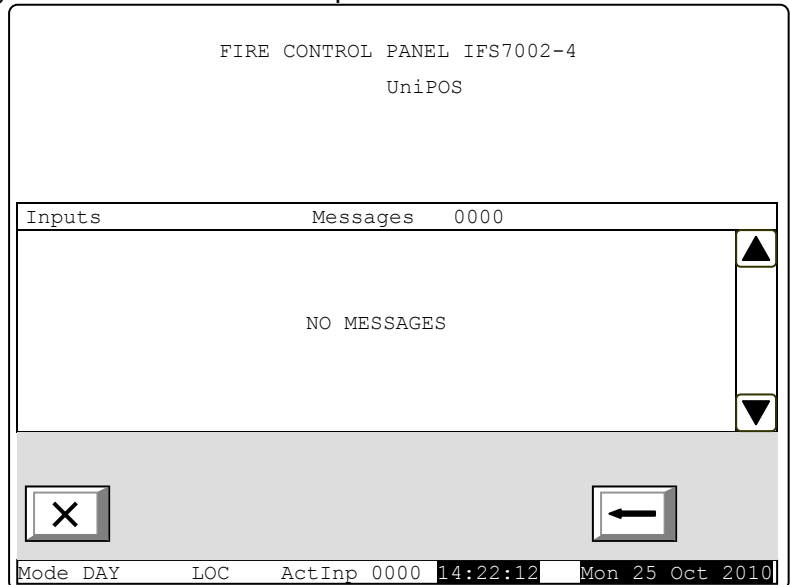

Where no activated addressable input devices are available, the following screen appears:



Where activated addressable input devices are available, the following screen appears:

Each message is displayed in two lines:

- Serial number of the message, loop number, loop address of the input device and device's input number, if more than one input is available – displayed on top line;
- Text message of the input – displayed on bottom line.

Buttons  and  at the panel right side allow for going to the next or to the previous message, if any.

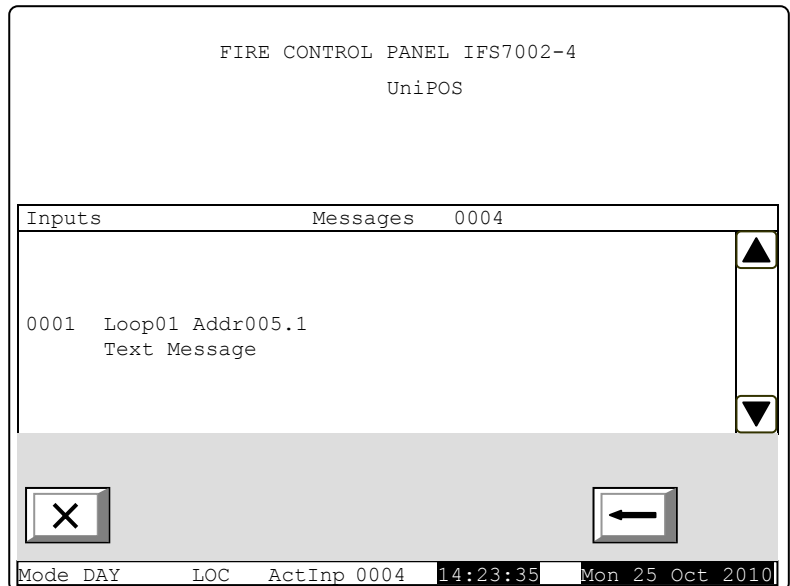

#### 12.2.5. Menu *Activated Outputs*

This menu displays information about the activated inputs and outputs. It has two sub-menus – for outputs activated in Fire condition and outputs activated from inputs.

12.2.5.1. Fire Condition Screen

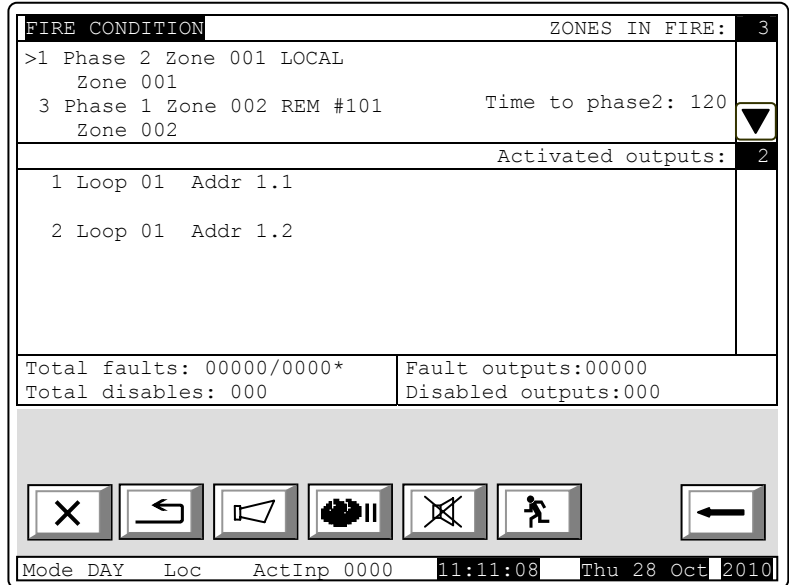

The screen displays information about:

- the total number of zones in Fire condition;
- the sequence number of the indicated fire condition;
- the phase of Fire condition detected by the fire control panel in this particular zone;
- the zone number;
- the fire control panel that is in Fire condition (Local or remote control panel). After the remote panel its address is also displayed;
- the remaining time in seconds before the fire control panel proceeds to phase Fire condition stage II



(indicated only in Fire condition stage I).



- text message for the respective zone
- the total number of activated outputs assigned to the zones in Fire condition;
- the activated output address and its loop;

Use the buttons  and  in the right part of the panel to display the next screen with activated outputs if their total number is greater than 4.



12.2.5.2. From the Input Screen

The screen displays information about:

- the total number of activated inputs;
- the activated input address and loop;
- the fire control panel where the activated input is;
- text message assigned to the input;
- the total number of activated outputs from the input;
- the activated output address and its loop;

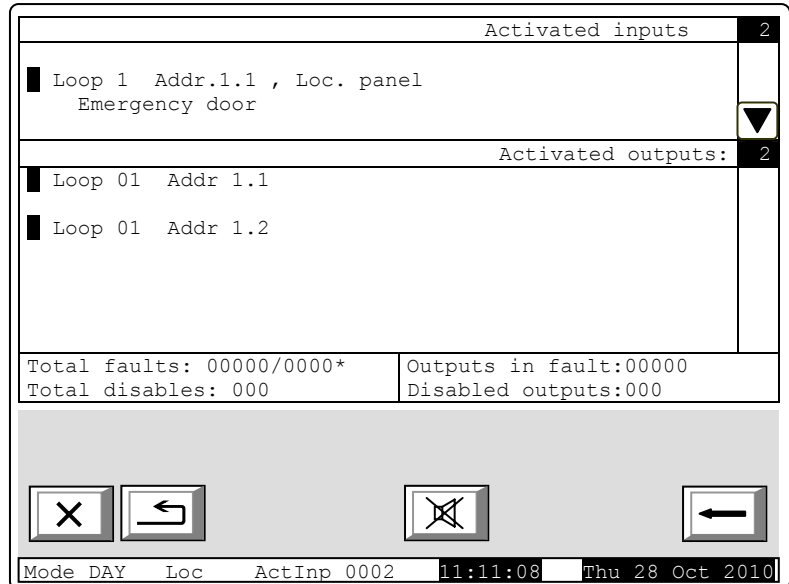
Use the buttons  and  in the right part of the panel to see the next activated output, if there are more;



Use the buttons  and  in the right part of the panel to display the next screen with activated outputs if their total number for the output is greater than 4.

Press the button  and enter password for Access Level 2 or 3 to reset the activated outputs and inputs.

12.2.6. Screen *Panel configuration*

The screen displays information associated with:

- The fire control panel local network; the possible conditions are *none*, *On* or *Of*. For the normal operation of the fire control panel the parameter has to be *On*. Otherwise the communication is not achieved between base PC board and loops PC board.
- Periphery devices; their possible conditions are *none*, *On* or *Off*;
- The power supply loop; its possible conditions are *none*, *On* or *Off*;
- The language of the text messages.

In the right part of the first row is displayed the software version of the Fire Control Panel for example "v16.08.10";

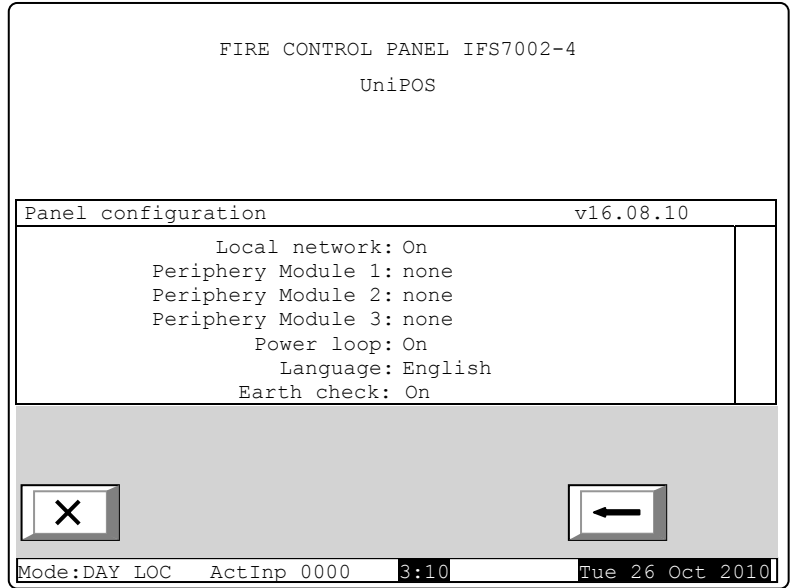

12.2.7. Menu *Panel parameters*

It is used when the fire control panel is connected in a global network or a local network with other fire control panels.

The menu has two sub-menus:

- Menu *Global Network*
- Menu *Local Network*

12.2.7.1. Menu *Network*

It displays information about RS232-network parameters:

- Rate [bits/s]-data exchange rate
- Address in the network
- Connection via modem – onformation if the communication is done via information, the screen displays "Yes" or "No", respectively

Telephone number – it is possible four 15-digit telephone numbers to be entered as the letter P – for pulse dialling and the letter T – for tonal dialling are entered before the respective number

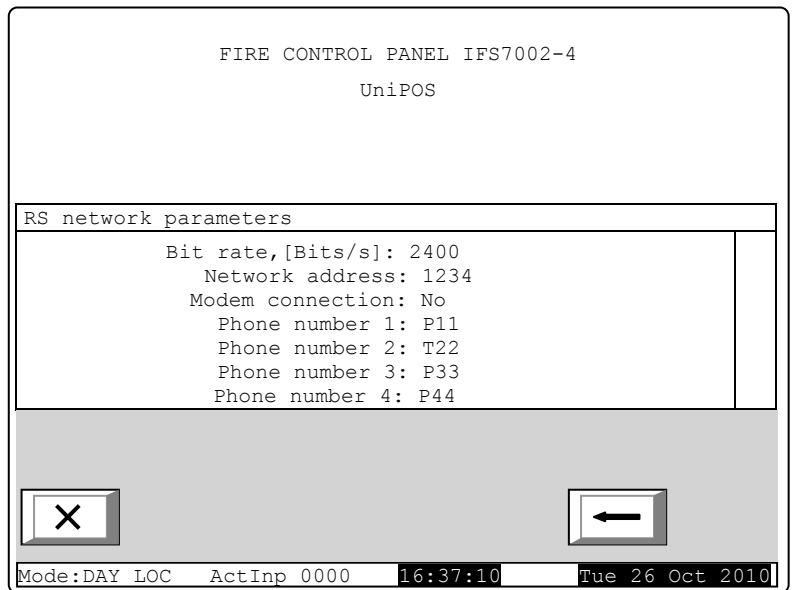

12.2.7.2. Menu *Local Network*

It displays information for the connection of the fire control panel in a local network with other fire control panels or repeaters, which is discussed in details in Appendix Interactive Fire Control Panel – Local Network Operation.

12.2.8. Menu *Loops*

The menu displays information for the loops and the devices integrated in the loops. It contains two identically organized submenus – for Loop 1 and for Loop 2; each submenu contains:

- Screen *Loop parameters*;
- Screen *List devices*
- Menu *Device parameters*.

12.2.8.1. Screen *Loop parameters*

The screen provides information for fire alarm loop parameters:

- Loop status – *On* or *Off*,
- Number of devices integrated in the loop.
- Addressation of devices integrated in the loop – automatic or manual

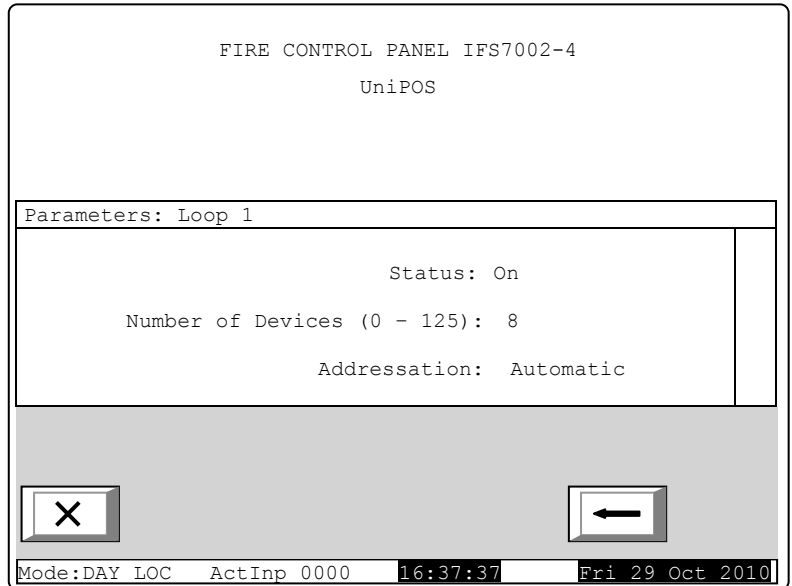

12.2.8.2. Screen *List devices*

The screen displays a list of the devices, by type and their respective number:

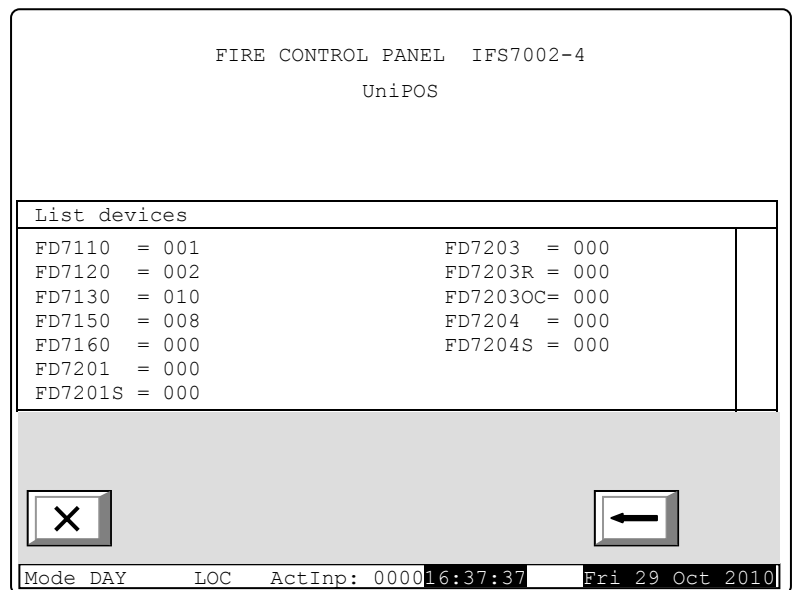

12.2.8.3. Menu *Device parameters*

The menu provides information for the parameters of devices integrated in the fire alarm loop. Enter the menu to display:



- A screen with the message *No integrated devices* – if no devices are available in the loop; the only option is to exit the menu;
- A screen where you can select a device and display its parameters – if some devices integrated in the loop are available:

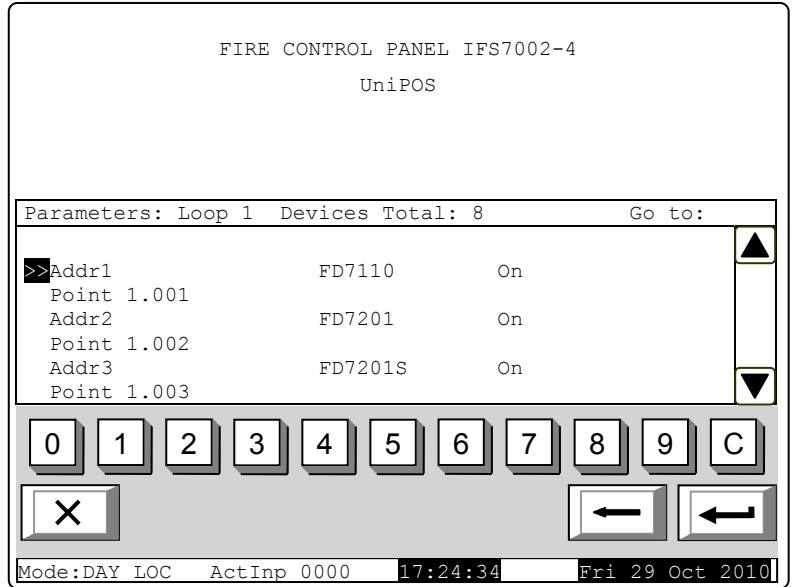

For each selected device you can display:

- the number (the address) in the loop, the type of the device and if the address is on or off – on the top line;
- Text message – in the line beneath.

The device is selected by arrow - "➤".



Buttons  and  seen in the right panel section appear when more than one device is available in the loop; the field *Go to* and the buttons with digits appear when more than three devices are available in the loop.

Buttons  and  allow the user to select next device or previous device (if any are available).

When you press a digit button, the field *Go to* is activated and a random 3-digit number can be entered in the field, showing the device's address in the loop. To edit the 3-digit number, press button  and you can delete the last entered digit.

When you press button  after a 3-digit number is already entered in the *Go to* field, you can select the device and its address is displayed in the field:

- If you enter 0 for a number, the device with address 1 will be selected;
- If you enter a number higher than the actual number of devices in the loop, the device having the highest number in the loop will be selected.

The number in the *Go to* field is then deleted; i.e. the field is deactivated.

If you press button  after you entered a number in the *Go to* field, the field will be deactivated.

If you press button  when the *Go to* field is empty, a screen with the parameters of the selected device will appear on the display:

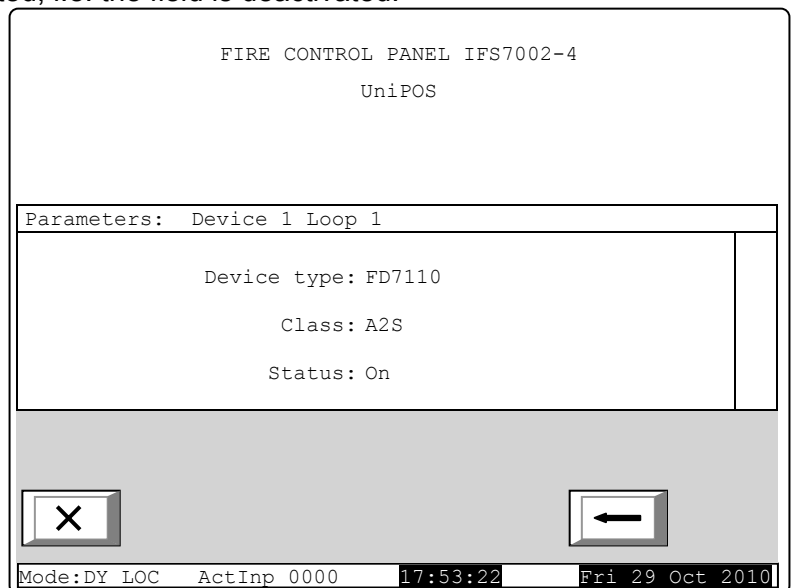

If the device is FD7201 or FD7201S type and we want it to operate as a monitored input, enter Settings /Loop / Loop X / Device Parameters and proceed as follows for FD7201 type to be setup as a monitored input:

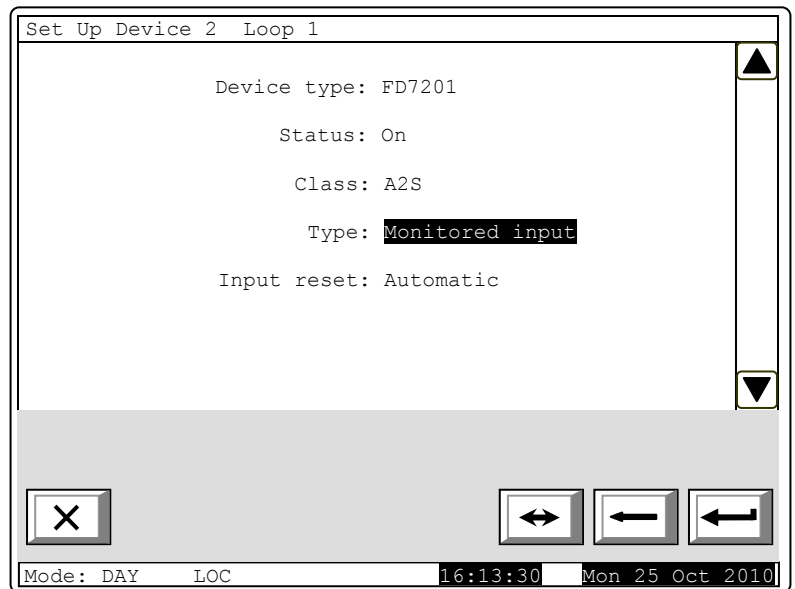

### 12.2.9. Menu Zones

The menu provides information for the parameters of all zones established in the fire control panel. Enter the menu to display:



- A screen with the message *No zones* – appears where no zones are available; the only option is to exit the menu;
- A screen where you can select a zone and display its parameters – appears where some zones are available:

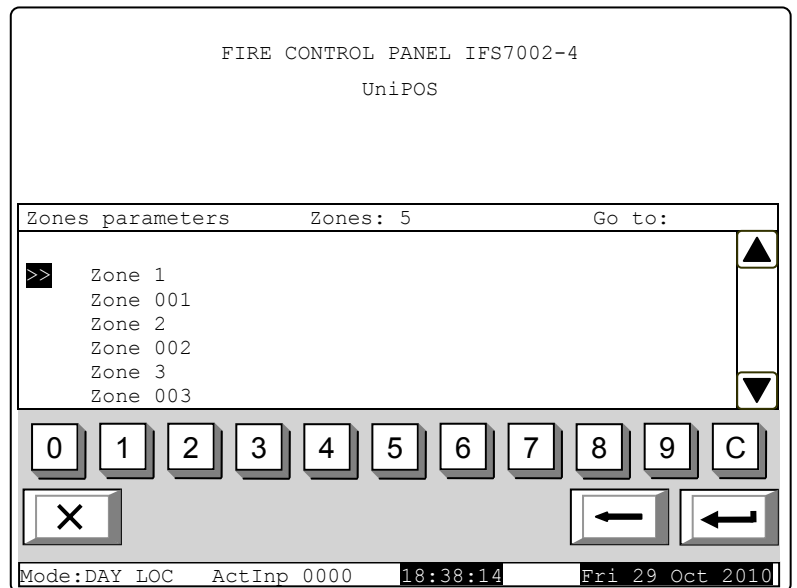

For each zone you can display:

- Its number – in the first line;
- Text message – in the line beneath.

The zone is selected by arrow –



Buttons  and  in the right panel section appear where more than one zone is available; the *Go to* field and the buttons with digits appear where more than three zones are available.

Buttons  and  allow the used to select the next or the previous zone (if any are available).

When you press a digit button, the field *Go to* is activated and a random 3-digit number designating the zone number can be entered in the field. To edit the 3-digit number, press button  and you can delete the last entered digit.

When you press button  after the 3-digit number is already entered in the *Go to* field you can select a zone and its address is displayed in the field:

- If you enter 0 for a number, the zone with address 1 will be selected;
- If you enter a number higher than the actual number of zones, the zone having the highest number will be selected.



The number in the *Go to* field is then deleted; i.e. the field is deactivated

When you press button  after the 3-digit number is already entered in the *Go to* field, the field will be deactivated.

When you press button  when the *Go to* field is empty, a menu with a group of parameters of the selected zone will appear on the display:

- Screen *Devices*;
- Menu *Fire Phase 1 Outputs*;
- Menu *Fire Phase 2 Outputs*;
- Screen *Zone parameters*.

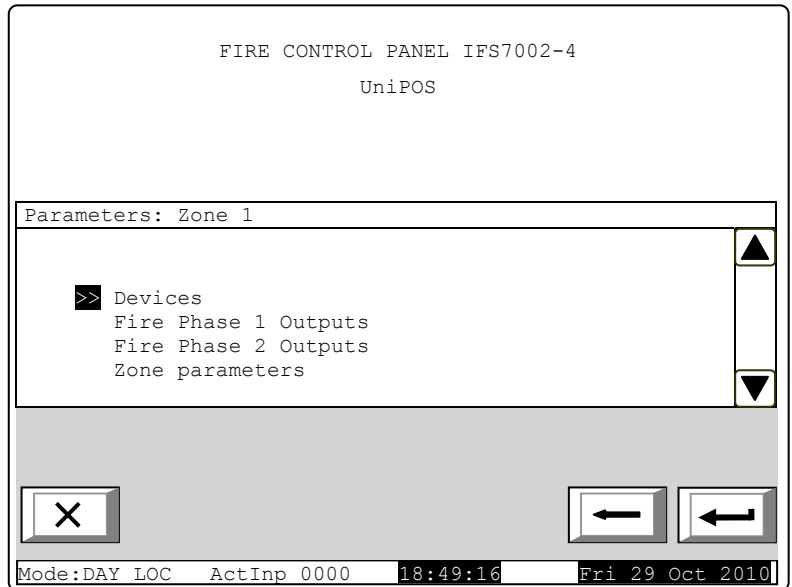

The arrow  points at the selected group of parameters.

Buttons  and  allow the user to select the next or the previous group of parameters (if any are available).



12.2.9.1. Screen *Devices*

It displays a list of fire detectors integrated in the zone:

The loop where each device is integrated, as well as its address is displayed on a list. The list is visualized in the form of pages; each page contains information for a maximum of 15 devices. Buttons  and  in the right panel section appear where more than one page is available; they allow the user to switch between the next and previous page (if available).

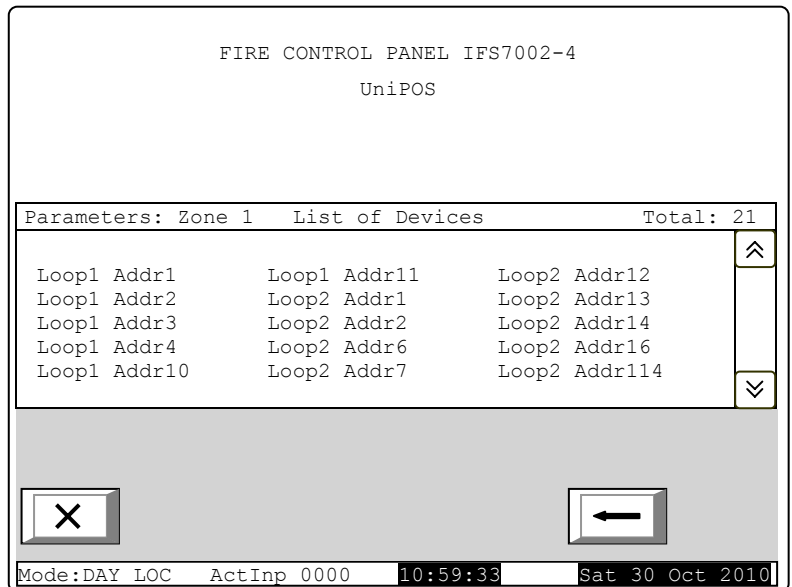

12.2.9.2. Menus *Fire Phase 1 Outputs* and *Fire Phase 2 Outputs*

The menus allow the user to display information for outputs, associated to the zone, which will respond at Fire Condition (phase Fire condition stage I or phase Fire condition stage II). The menus contain:

- Screen *Panel Outputs*;
- Screen *List of addressable outputs*.

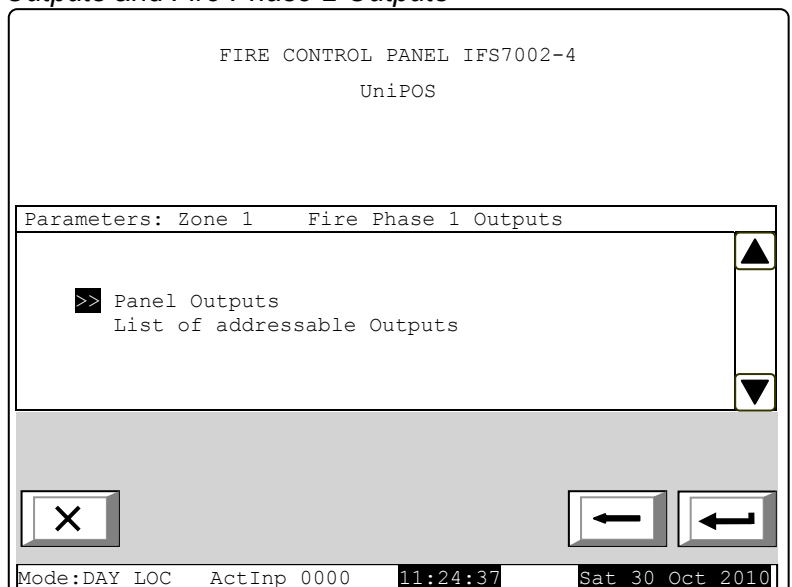

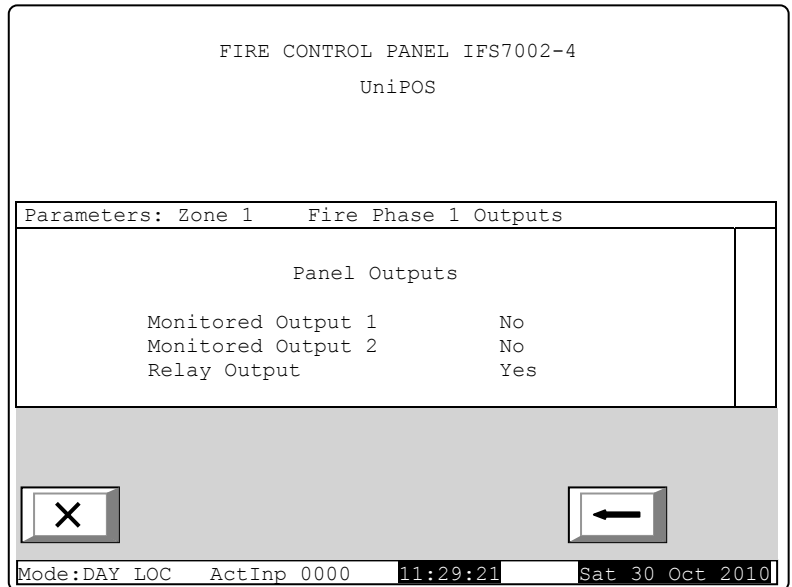

The screen *Panel Outputs* provides information for outputs responding to the relevant phase of Fire condition in the zone:

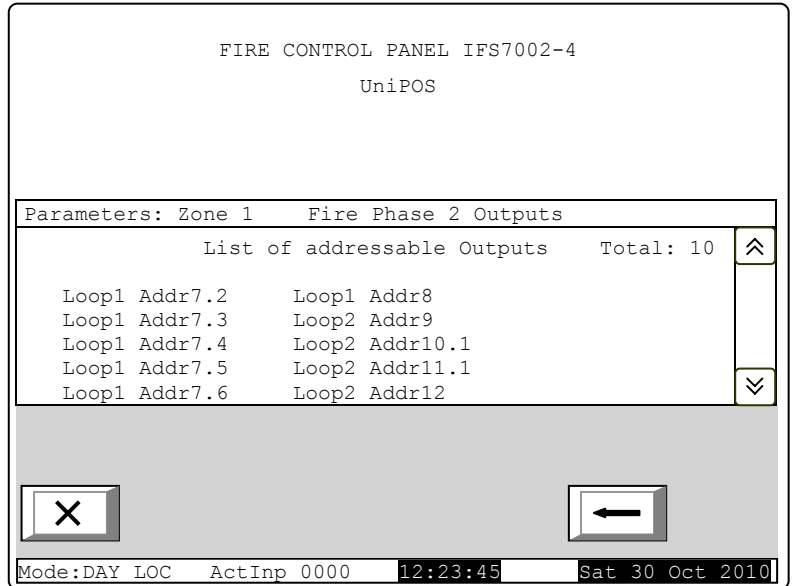

The screen *List of addressable outputs* displays information for addressable outputs associated to the zone. If no such outputs are available, a screen displaying the message *No addressable outputs activated upon Fire condition Phase X* appears. (X stands for the phase number – 1 or 2). The only option then is to exit the screen. If addressable outputs associated to the zone are available, their list is visualized. Loop number, device address in the loop and the number of the output in the device, if more than one is displayed for each device. The list is visualized in pages, each page containing a maximum of 10 devices.



The buttons  and  on the right panel section appear where more than one page is available and allow the user to switch between next and previous page.



12.2.9.3. Screen *Zone Parameters*

The screen displays common zone parameters:

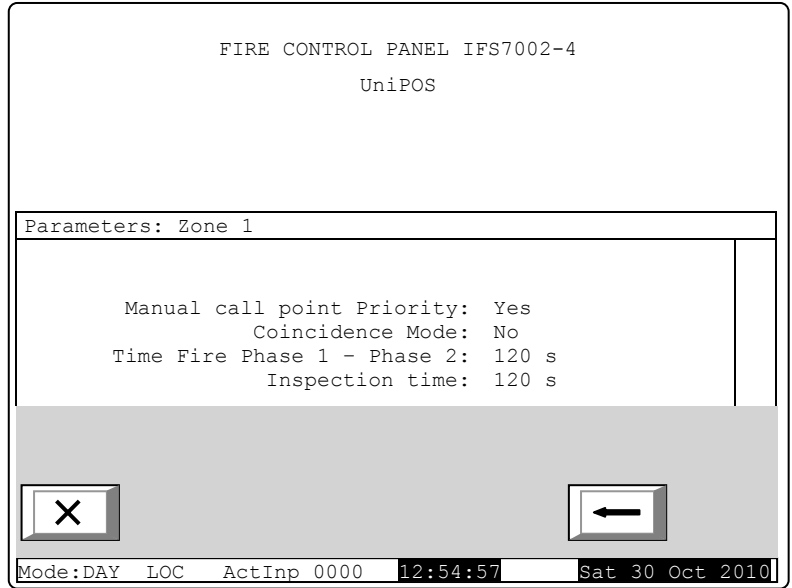

- Manual call point priority – where the manual call points have priority, their response will force the zone to enter Fire Condition Phase 2; where the manual call points do not have priority, their response will force the zone to enter Fire Condition Phase 1, or, in other words, the manual call point will be treated as automatic fire detectors;
- Coincidence Mode – when operating in Coincidence Mode, the zone will enter Fire Condition Phase 1 upon activation of at least two low priority fire detectors;
- Time Fire Phase 1 – Phase 2 – this is the time delay before the fire control panel proceeds from Fire Condition Stage I to Fire Condition Stage II in this particular zone ;
- Inspection time – time added to the remaining time, by pressing button , before the zone proceeds from Fire Condition Stage I to Fire Condition Stage II.





12.2.10. Menu *Device Status*

The menu provides information for the current status of the devices. Enter the menu to display:

- A screen with the message *No integrated devices*, where no devices are present; the only option is to exit the menu;
- A screen for the status of the first device, where some devices are present:

Buttons  and  seen on the right panel section appear when more than one device is available; the *Go to* field and the digit buttons appear when more than two devices are available.

Buttons  and  allow the user to switch between the next and the previous device (if available).

When you press a digit button, the button  appears and the *Go to* field is activated; then you may enter a random 3-digit number for the

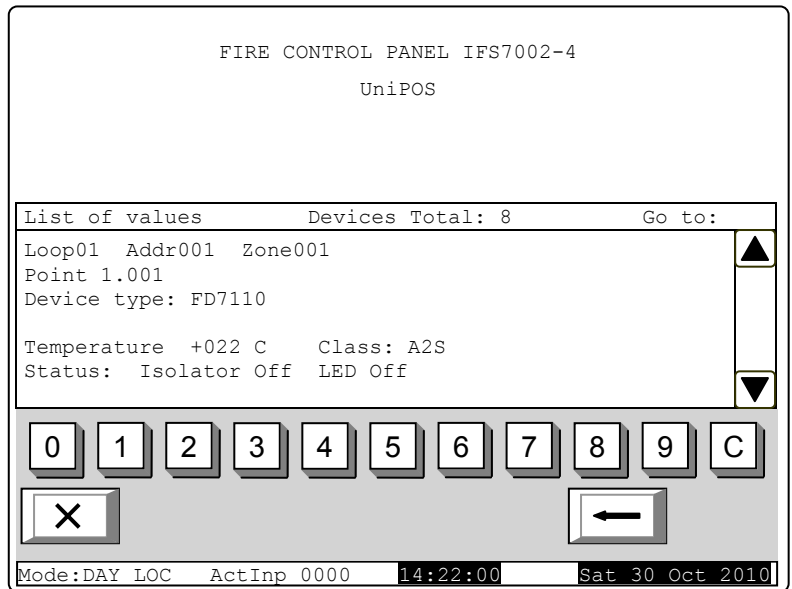

device. To edit the number press button , and the last entered digit is deleted.



The devices get numbers according to the following sequence: from the first device in Loop 1 to the last device in Loop 2; from the first device in Loop 2 to the last device in Loop 2.

When you press button  it displays a screen for the status of the device, which number is in the field:

- If you enter 0, the first device will be selected;

- If you enter a number higher than the actual number of devices, the last device will be selected.

At the same time button  and the number in the Go to field disappear, i.e. are deactivated.

When you press button  and a number is already entered in the *Go to* field, button  and the field are deactivated.

Information for each device, saved in the fire control panel is displayed in the first three lines on the panel:

- Number of the loop where the device is integrated and device address in the loop;
- Number of the zone where the device is integrated – for fire detectors only;
- Text message for the device;
- Device type.

The rest of the panel contains information that is being sent by the device. If no communication with the device is available, the message *Removed device* appears. Otherwise information specific for each type device is displayed, including:

- For automatic fire detectors FD7110 and FD7120:
  - ◆ The temperature measured by the fire detector, in Celsius;
  - ◆ Temperature class of the fire detector;
  - ◆ Status of the detector's isolator – Off (no response) or On (responded);
  - ◆ LED status – Off (not illuminated/ not flashing) or On (illuminated);
  - ◆ Information for Fire condition – the text message *Fire Alarm* appears only when the detector responded;
  - ◆ Information for Fault condition – the text message *Fault* is displayed only when the fire detector responded to a fault condition;
- For automatic fire detectors FD7130:
  - ◆ The smoke concentration measured by the fire detector, in percentage, against the response threshold for fire condition;
  - ◆ Detector contamination, in percentage, against the maximum permissible contamination value;
  - ◆ Status of the detector's isolator – Off (no response) or On (responded);
  - ◆ LED status – Off (not illuminated/ not flashing) or On (illuminated);
  - ◆ Information for the level of detector contamination– the text message *Contaminated* appears only if the fire detector is contaminated and needs cleaning;
  - ◆ Information for Fire condition – the text message *Fire Alarm* appears only when the detector responded;
  - ◆ Information for Pre-alarm – the text message *PreAlarm* appears only if the smoke concentration value is near the response threshold for fire condition;
  - ◆ Information for Fault condition – the text message *Fault* is displayed only when the fire detector responded to a fault condition;
- For manual call points FD7150:
  - ◆ Status of the manual call point isolator – Off (no response) or On (responded)
  - ◆ LED status – Off (not illuminated/ not flashing) or On (illuminated);
  - ◆ Information for Fire condition – the text message *Fire Alarm* appears only when the manual call point responded;
  - ◆ Information for Fault condition – the text message *Fault* is displayed only when the manual call point responded to a fault condition;
- For automatic fire detectors FD7160:
  - ◆ The temperature measured by the fire detector, in Celsius;
  - ◆ Temperature class of the fire detector;
  - ◆ The smoke concentration measured by the fire detector, in percentage, against the response threshold for fire condition;
  - ◆ Detector contamination, in percentage, against the maximum permissible contamination value;
  - ◆ Status of the detector's isolator – Off (no response) or On (responded);

- ◆ LED status – Off (not illuminated/ not flashing) or On (illuminated);
  - ◆ Information for the level of detector contamination– the text message *Contaminated* appears only if the fire detector is contaminated and needs cleaning;
  - ◆ Information for Fire condition – the text message *Fire Alarm* appears only when the detector responded;
  - ◆ Information for Pre-alarm – the text message *PreAlarm* appears only if the smoke concentration value is near the response threshold for fire condition;
  - ◆ Information for Fault condition – the text message *Fault* is displayed only when the fire detector responded to a fault condition;
- For conventional line-monitoring modules with heat detector FD7201:
- ◆ The current value measured in the conventional fire alarm line, connected with the module;
  - ◆ Information for fire condition in the conventional line – the text message *Fire Alarm* appears only when a detector in the conventional line responded;
  - ◆ Information for short circuit in the conventional line – the text message *Short* appears only if short circuit is detected in the conventional line;
  - ◆ Information for fault condition: break in the conventional line – the text message *Open* appears only if a break in the conventional line is detected;
  - ◆ Information for fault condition: removed fire detector in the conventional line – the text message *Removed FD* appears only when a conventional line detector is removed;
  - ◆ The temperature in the module, measured by the fire detector, in Celsius;
  - ◆ Temperature class of the detector in the module;
  - ◆ Status of the detector's isolator – Off (no response) or On (responded)
  - ◆ LED status – Off (not illuminated/ not flashing) or On (illuminated);
  - ◆ Information for Fire condition – the text message *Fire Alarm* appears only when the heat detector in the conventional line-monitoring module responded or when a fire detector in the conventional line responded;
  - ◆ Information for fault condition – the text message *Fault* appears only if the conventional line-monitoring module detected a fault condition;
- For adapters type FD7201S:
- ◆ The current value measured in the conventional line, connected to the adapter;
  - ◆ Information for Fire condition in the conventional line – a text message *Fire* is displayed only in case a fire detector has been activated in the conventional line;
  - ◆ Information for fault condition – *Short circuit in conventional line* – a text message *Short* is displayed only in case a short circuit has been detected in the conventional line;
  - ◆ Information for fault condition – *Break in conventional line* – a text message *Break* is displayed only when the conventional line has been cut off;
  - ◆ Information for fault condition – *Removed device in conventional line* – a text message *Removed FD* is displayed only in case a device has been removed from the conventional line;
  - ◆ Status of the adapter's isolator– *Off* (not activated) or *On* (activated);
  - ◆ Status of the LED – *Off* (not emitting light/not flashing) or *On* (emitting light/flashing);
  - ◆ Information for Fire condition – a text message *Fire* is displayed only in case a fire detectors has been activated in the conventional line;
  - ◆ Information for fault condition – a text message *Fault* is displayed only in case the adapter has registered a fault;
- For input/output modules FD7203 (3 input/5 outputs):
- ◆ Outputs switched on – a list of switched on outputs, designated „Rel1” to „Rel5”, or the text message *None* appears if no outputs are switched on;
  - ◆ Device's activated inputs – a list of activated inputs, designated as „In1” to „In3”, or a text message *None*, if no outputs have been switched on;
  - ◆ Input status – „0” (no input signal) or „1” (input signal);
  - ◆ Status of the isolator of the module at the power supply loop – Off (no response) or On (responded);

- ◆ Status of the isolator of the module – Off (no response) or On (responded);
- ◆ LED status – Off (not illuminated/ not flashing) or On (illuminated);
- ◆ Information for fault condition – the text message *Fault* appears only if the module detected a fault condition
- For Input/Output modules type FD7203OC and FD7203R:
  - ◆ Status of device's output – On or Off;
  - ◆ Status of device's isolator in the power loop– Off (not activated) or On (activated);
  - ◆ Status of device's isolator – Off (not activated) or On (activated);
  - ◆ Status of the LED – *Off* (not emitting light/not flashing) or *On* (emitting light/flashing);
  - ◆ Information for fault condition – a text message *Fault* is displayed only in case the module has registered a fault;
- For single output modules FD7204S:
  - ◆ Status of the output – *On* or *Off*;
  - ◆ Status of the isolator of the module at the power supply loop – Off (no response) or On (responded);
  - ◆ Status of the isolator of the module – Off (no response) or On (responded)
  - ◆ LED status – Off (not illuminated/ not flashing) or On (illuminated)
  - ◆ Information for fault condition – the text message *Fault* appears only if the module detected a fault condition.
- For single output modules FD7204:
  - ◆ Status of the output – *On* or *Off*;
  - ◆ Status of battery;
  - ◆ Status of the isolator of the module – Off (no response) or On (responded)
  - ◆ LED status – Off (not illuminated/ not flashing) or On (illuminated)
  - ◆ Information for fault condition – the text message *Fault* appears only if the module detected a fault condition.
- For input/output modules FD7203 (1 input/1 output) and FD7203 (10 inputs/16 outputs):
  - ◆ Outputs switched on – a list of switched on outputs or the text message *None* appears if no outputs are switched on;
  - ◆ Device's activated inputs – a list of activated inputs or a text message *None*, if no inputs have been switched on;
  - ◆ Status of the isolator of the module at the power supply loop – Off (no response) or On (responded);
  - ◆ Status of the isolator of the module – Off (no response) or On (responded);
  - ◆ LED status – Off (not illuminated/ not flashing) or On (illuminated);
  - ◆ Information for fault condition – break or short circuit

#### 12.2.11. Menu *Inputs*

The menu displays information for addressable inputs parameters. When you enter the menu the following screens are displayed:

- Where addressable input devices are not available – a screen with the message *No Outputs* appears; the only option is to exit the menu;



- Where addressable input devices are available – a screen for selection of the first addressable input whose parameters are to be displayed:

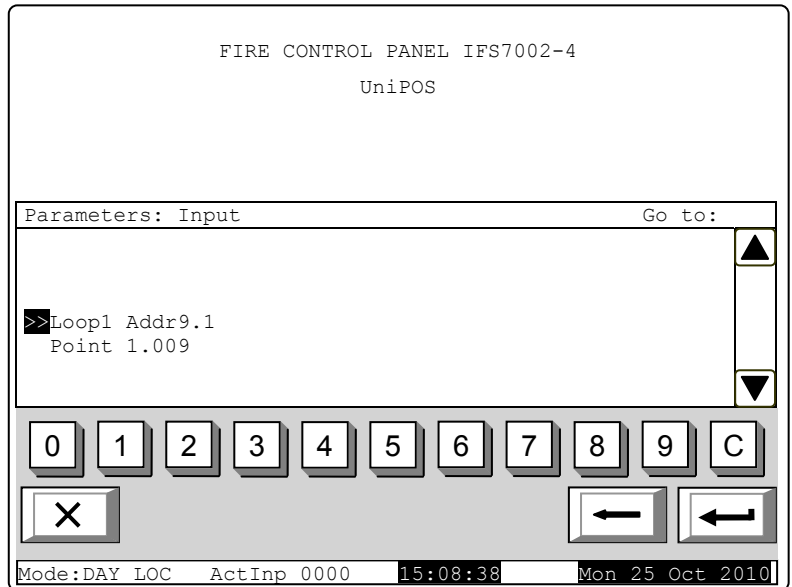

For each addressable input are displayed:

- Number of the loop, input devices address in the loop and the number of the input in the device if more than one – in the upper line;
- Text message for the device – in the bottom line.

The selected input is pointed by arrow – „>>“.



Buttons  and  seen on the right panel section appear when more than one addressable input is available; the Go to field and the digit buttons appear when more than one addressable input device is available.

Buttons  and  allow the user to switch between the next and the previous addressable input (if available).

When you press a digit button, the arrow „>>“ before the selected addressable input disappears and the Go to field is activated; then you may enter a random 3-digit number for the device. To edit the number press button , and the last entered digit is deleted.

The devices get numbers according to the following sequence: from the first device in Loop 1 to the last device in Loop 2; from the first device in Loop 2 to the last device in Loop 2.

When you press button  as soon as a number is entered in the Go to field, the first addressable input of the first addressable input device is selected; its number is equal to or higher than the number in the field:

- If you enter 0, the first addressable input will be selected;
- If you enter a number higher than the number of the last addressable input device, the last addressable input will be selected.

Simultaneously, the number in the Go to field disappears, i.e. the field is deactivated.

When you press button  as soon as a number is entered in the Go to field, it will be deactivated and the arrow „>>“ will appear before the selected addressable input.

When you press button  and the arrow „>>“ is visible (Go to field is empty) a screen displaying the parameters of the selected addressable input appears:

The screen provides the following information:

- Number and text of the text message that will be seen if the addressable input is triggered (the message shall be set in advance);
- The number of the addressable outputs that will be triggered upon activation of the input;

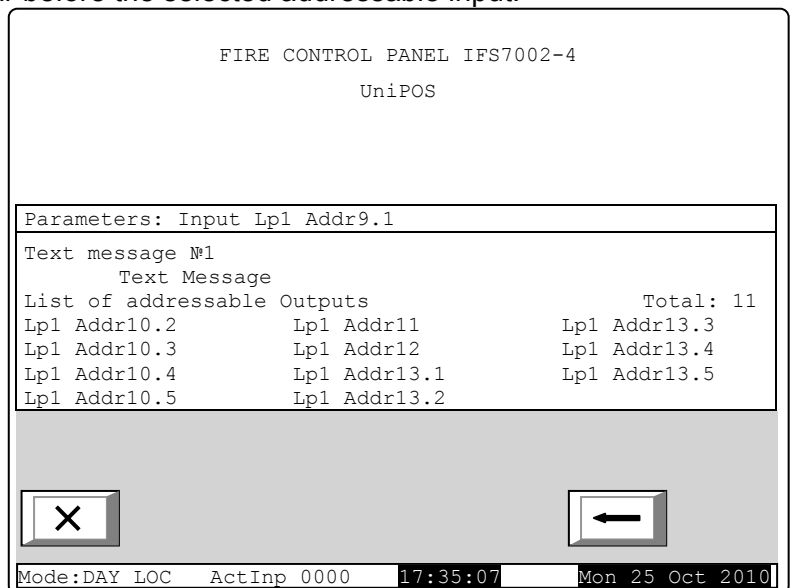

- A list of the addressable outputs or the message No addressable outputs activated by this input.

#### 12.2.12. Menu *Archive*

The menu provides information for all events saved in the energy independent memory of the fire control panel.

The following events are registered in the fire control panel: fire condition, disables, test mode, fault condition and general conditions. For each event are displayed: number of the event as per the selected filter (total; fire conditions; fault conditions; period), serial number of the event in the archive, event code, event time and some specific information depending on the event type.

The code and the specific information for events from the type *Fire condition* are

Event character	Event code	Specific information
Fire alarm zone in Fire condition stage I upon activation of a device	Fire1	Zone number; Loop where the device is integrated; Device number in the loop; Text message of the zone; Text message of the device
Fire alarm zone in Fire condition stage II upon activation of a device (manual call point)	Fire2	
Response from a device in a zone already in Fire condition, without changes in the fire phase	Fire	
Fire alarm zone in Fire condition stage II where <i>Time Fire Phase 1 – Phase 2</i> has expired	Fire 2	Zone number; Text message of the zone
Fire alarm zone in Pre Fire Condition	PreFire	Zone number; Loop where the device is integrated; Device number in the loop; Text message of the zone; Text message of the device
Fire alarm zone exited PreFire	PreFire reset	
Fire control panel exited Fire condition	Fire reset	–

The code and the specific information for events from the type *Disables* are

Event character	Event code	Specific information
Zone disabled	Disable Zone	Zone number; Text message of the zone
Zone enabled	Disable Zone reset	
Device disabled (fire alarm detector or input device)	Disable Device	Zone number; Loop where the device is integrated; Device number in the loop; Text message of the zone; Text message of the device
Device enabled (fire alarm detector or input device)	Disable Device reset	
Output device disabled	Disable Addressable Output	Loop where the device is integrated; Device number in the loop; Text message of the device
Output device enabled	Disable Addressable Output reset	
Monitored output disabled	Disable Monitored output	Monitored output number

Monitored output enabled	Disable Monitored output reset	
--------------------------	--------------------------------	--

The code and the specific information for events from the type *Test* are:

Event character	Event code	Specific information
Fire alarm zone set to Test Mode	Zone in Test	Zone number; Text message of the zone
Reset of Test Mode	Zone in Test reset	

The code and the specific information for events from the type *Fault* are

Event character	Event code	Specific information
Fire alarm zone in fault condition	Fault in Zone	Zone number; Text message of the zone
Fire alarm zone exited fault condition	Fault in Zone reset	
Fault condition <i>Removed device</i>	Removed device	Zone number; Loop where the device is integrated; Device number in the loop; Text message of the zone; Text message of the device
Fault condition <i>Removed device</i> exited	Removed device reset	
Fault condition <i>Fault in device</i>	Fault in device	
Fault condition <i>Fault in device</i> exited	Fault in device reset	
Fault condition <i>Communication error</i>	Communication error	
Fault condition <i>Communication error</i> exited	Communication error reset	
Fault condition <i>Device not initialized</i>	Device not initialized	
Fault condition <i>Device not initialized</i> exited	Device not initialized reset	
Fault condition <i>Fire detector contaminated</i>	Detector contaminated	
Fault condition <i>Different Device ID</i>	Different device ID	
Fault condition <i>Different Device Type</i>	Different device type	
Fault condition <i>Different Device Class</i>	Different device class	
Fault condition <i>Device exchanged</i>	Device exchanged	
Fault condition <i>Device isolator activated</i>	Isolator On	
Fault condition <i>Device isolator activated</i> exited	Isolator Off	Loop where the device is integrated; Device number in the loop; Text message of the device
Fault condition <i>Device isolator tot power loop activated</i>	Power loop isolator On	
Fault condition <i>Device isolator at power loop activated</i> exited	Power loop isolator Off	Fire alarm loop number
Fault condition <i>Short circuit in a loop</i>	Short circuited Loop	
Fault condition <i>Short circuit in a loop</i> exited	Short circuited Loop reset	

Event character	Event code	Specific information
Fault condition <i>Fire alarm loop open</i>	Open Loop	
Fault condition <i>Fire alarm loop open</i> exited	Open Loop reset	
Fault condition <i>Fire alarm loop not initialized</i>	Loop not initialized	
Fault condition <i>Fire alarm loop not initialized</i> exited	Loop not initialized reset	
Fault condition <i>Number of devices in the fire alarm loop exceeded</i>	Number of devices exceeded	
Fault condition <i>Number of devices in the fire alarm loop exceeded</i> exited	Number of devices exceeded reset	
Fault condition <i>Short circuit in the power loop</i>	Short circuited Loop	-
Fault condition <i>Short circuit in the power loop</i> exited	Short circuited Loop reset	
Fault condition <i>Break in the power loop</i>	Open Power Loop	
Fault condition <i>Break in the power loop</i> exited	Open Power Loop reset	
Fault condition <i>Short circuit in monitored output</i>	Short circuited monitored output	Monitored output number
Fault condition <i>Short circuit in a monitored output</i> exited	Short circuited monitored output reset	
Fault condition <i>Break in monitored output</i>	Open monitored output	
Fault condition <i>Break in monitored output</i> exited	Open monitored output reset	
Fault condition <i>Fault in mains supply</i>	Fault Mains Power	-
Fault condition <i>Fault in mains supply</i> exited	Fault Mains Power reset	
Fault condition <i>Fault in back up battery supply</i>	Fault Battery	
Fault condition <i>Fault in back up battery supply</i> exited	Fault Battery reset	
Fault condition <i>Battery low due to interruption in mains supply</i>	Battery Low	
Fault condition <i>Battery low due to interruption in mains supply</i> exited	Battery Low reset	
Fault condition <i>Fault in auxiliary supply device for external devices</i>	Fault Auxiliary Power	
Fault condition <i>Fault in auxiliary supply device for external devices</i> exited	Fault Auxiliary Power reset	
Fault condition <i>Short circuit in earthing</i>	Fault in Earthing	



Event character	Event code	Specific information
Fault condition <i>Short circuit in earthing</i> exited	Fault in Earthing reset	
Fault condition <i>Fault in Module 0</i>	Fault Module 0	
Fault condition <i>Fault in Module 0</i> exited	Fault Module 0 reset	
Fault condition <i>Watchdog reset</i>	Watchdog reset	

## Notes:

- Exit of fault condition *Detector contaminated*, for optical-smoke detectors, is only possible through removing and cleaning the fire detector (i.e. fault condition *Removed device* is registered).
- Exit of fault conditions *Different Device ID*, *Different Device Type*, *Different Device Class* and *Device exchanged* is possible through removing the detector (i.e. fault condition *Removed device* is registered) or through Fire control panel Set Up (i.e. after event *Manual Set Up* or *Remote Set Up*).
- Fault condition *Device exchanged* occurs for two devices minimum.
- Fault condition *Device isolator activated* occurs for two devices (short circuit in the loop between two devices) or is combined with fault condition *Short circuit in a fire alarm loop* (short circuit in the loop between the control panel and the first/last device). In case more than one short circuit is registered in the loop, fault *Device removed* for the devices in the isolated segment of the loop will also occur.
- Fault condition *Device isolator to power loop activated* occurs for two devices (short circuit in the loop between both devices) or is in combination of fault *Short circuit in power loop* (short circuit in the loop between the control panel and the first/last device). If more than one short circuit in the loop is registered, fault *Device isolator to power loop activated* for the devices in the isolated segment will also occur.
- Exit of faults *Fire alarm loop not initialized* and *Number of devices in the fire alarm loop exceeded* can be done through re-initialization of the fire control panel (i.e. after the event *Reset Panel*, *Manual Set Up* or *Remote Set Up*)
- Exit of fault *Battery low due to interruption of mains supply* is usually followed by *Reset Panel*
- Event *Watchdog Reset* triggers reset of the fire control panel.

The code and the specific information for events from the type *General* are:

Event character	Event code	Specific information
Reset of the fire control panel	Reset Panel	–
Manual Set Up	Manual Set Up	
Remote Set Up	Remote Set Up	



Menu *Archive* contains the following subordinate menus:

- Menu *Total* – all records saved in the archive will be displayed (filter *Total*);
- Menu *Fire conditions* – only records for fire conditions will be displayed (filter *Fire*);
- Menu *Fault conditions* – only records for fault conditions will be displayed (filter *Fault conditions*);
- Menu *Period* – only records occurred during a specified period will be displayed (filter *After date*, *Before date* or *Between dates*).

#### 12.2.12.1. Menu *Total*

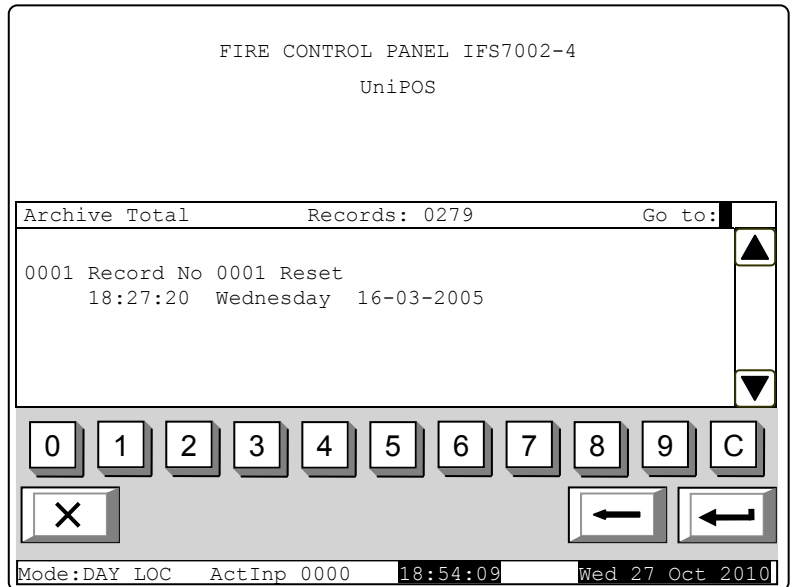
The menu displays all records of events saved in the energy independent memory of the fire control panel. Filter *Total* is selected, where the serial number of the event in the filter coincides with the serial number of the event in the archive. Enter the menu to display the record for the last saved event:



Buttons  and  on the panel right section are seen when more than one record is available in the archive, and allow the user to scroll the page to the previous or to the next event (if available).

Using the digit buttons a random 4-digit number for the record may be

entered in the *Go to* field. To edit the number press button , and the last entered digit is deleted.

When you press button  it displays the record having the number entered in the *Go to* field

- If no number is entered or the number is 0, the first record (the newest one) will be selected;
- If you enter a number higher than the actual number of records in the archive, the last records (the oldest one) will be selected.



Simultaneously, the number on the *Go to* field disappears.

12.2.12.2. Menu *Fire conditions*

The menu displays only the records for events – filter *Fire conditions* is selected. Enter the menu to display:

- Where no records of fire conditions are available – a screen with the text message *No records in archive*, the only option is to exit the menu;
- Where records of fire conditions are available – the record of the first (the most recent) event:



Buttons  and  on the panel right section are seen when more than one record for fire condition is available in the archive, and allow the user to scroll the page to the previous or to the next event (if available).



At the panel right corner the fire counter will be displayed (the counter can be reset only at Access Level 4).

12.2.12.3. Menu *Fault conditions*

The menu displays only the records for fault conditions – filter *Fault conditions* is selected. Enter the menu to display:

- Where no records for fault conditions are available – a screen with the text message *No records in archive*; the only option is to exit the menu;

- Where records for fault conditions are available – the record of the first (the most recent) event.

Buttons  and  on the panel right section are seen when more than one record for fault condition is available in the archive, and allow the user to scroll the page to the previous or to the next event (if available).

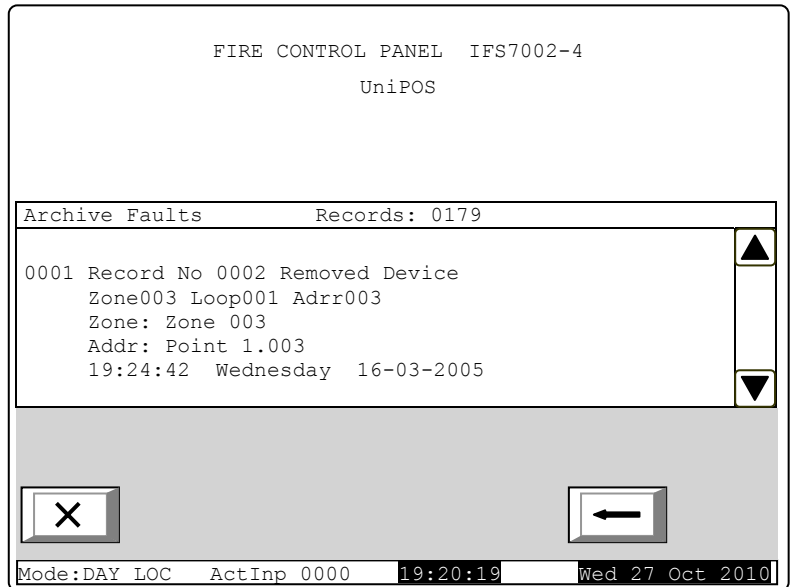



12.2.12.4. Menu *Period*

The menu displays only records of events that occurred during a specified period. It contains the following subordinate menus:

- Menu *After date* – displays only records of events that occurred after the specified date (filter *After date*);
- Menu *Before date* – displays only records of events that occurred before a specified date (filter *Before date*);
- Menu *Between dates* – displays only records of events that occurred between two specified dates (filter *Between dates*).

Enter one of the subordinate menus to display the screen where you can specify the period you need:



The menu *After date* can be displayed only from the line *From date*; the menu *Before date* can be displayed only from the line *To date*.

Buttons  and  on the right panel section are enabled only in menu *Between dates* and allow the user to switch between the lines *To date* – *From date*.

Use the digit buttons to specify the needed dates. The cursor „█” points over the position for the relevant figure. To edit the figures,

press button , the figure before the cursor will be deleted.

The dates shall comply with the format indicated on the screen (the separator „-” appears or is deleted automatically). Incorrect dates are unacceptable – if you enter such date (for example day higher than 31, or month higher than 12) the incorrect figure is not displayed.

When you enter a subordinate menu from an upper hierarchy menu (i.e. from menu *Period*) it is compulsory to enter the dates (otherwise visualization of the relevant records saved in the archive is not possible, i.e. button  is not active). If you switch back to a lower hierarchy screen, where periods are specified (i.e. from the screen for selected archive records) button  is active; if the

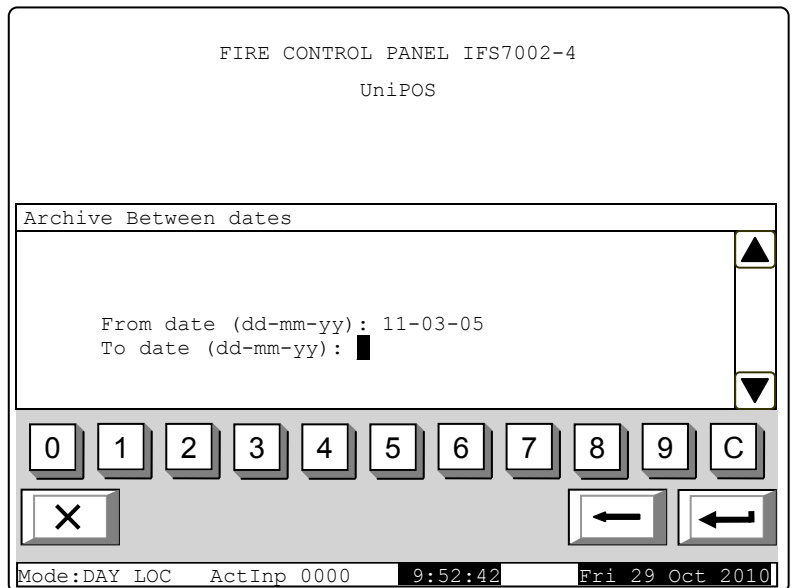



dates are not completely entered, then the previously entered valid dates will be used. Press button



to display:

- Where no records of events for the specified period are available – a screen with the text message *No records in archive*; the only option is to switch back to the screen where periods are specified;
- Where records of events for the specified period are available – the record of the first (the most recent) event:

Buttons  and  on the right panel section are enabled if more than one record is available in the archive; they allow the user to switch between the next and the previous record (if any).

Using the digit buttons to enter in the *Go to* field a random 4-digit number for the event in the selected filter. To edit the number press button  and the last digit will be deleted.

Press button  to display the record whose number is in the *Go to* field:

- If no number is entered or the number is 0, the first (the most recent) record will be selected;
- If the number is higher than the actual numbers of all records in the archive, the last (the oldest) record will be selected.

Simultaneously, the number in the *Go to* field is deleted.

12.2.13. Menu *Select Loc/Rem. Control Panel* – to select a particular control panel that will undergo set up or which parameters, events or status will be reviewed (Appendix *Interactive Fire Control Panel IFS7002 – Local Network Operation*).

### 12.3. Menu *System functions*

The menu contains the following subordinate menus and functions:

- Disables;
- Zones in test;
- Set Clock;
- Set Mode;
- Check LEDs and Buzzer.

Access to the subordinate menus is allowed at Access Level 2, so as soon as you enter the menu, a screen for password will appear:

Enter the password using the digit buttons – press a button to insert a digit on the place of the cursor „█“; the previous text and the cursor move one position to the right. Move the cursor to the left or to the right using buttons ◀ and ▶.

Press the button **C** to delete:

- The digit under the cursor;
- The digit to the left of the cursor if no digit is available under the cursor.

The maximum length of the password is 10 symbols. If you press a digit button after the 10-symbol password is entered, the digit is not accepted and will not be entered.

If wrong password is entered, when you press button ◀ the digits will be deleted and the cursor will move back to the first position. If one of the 10 passwords for Access Level 2 or Access Level 3 is entered, when you press button ◀ the menu will become active.

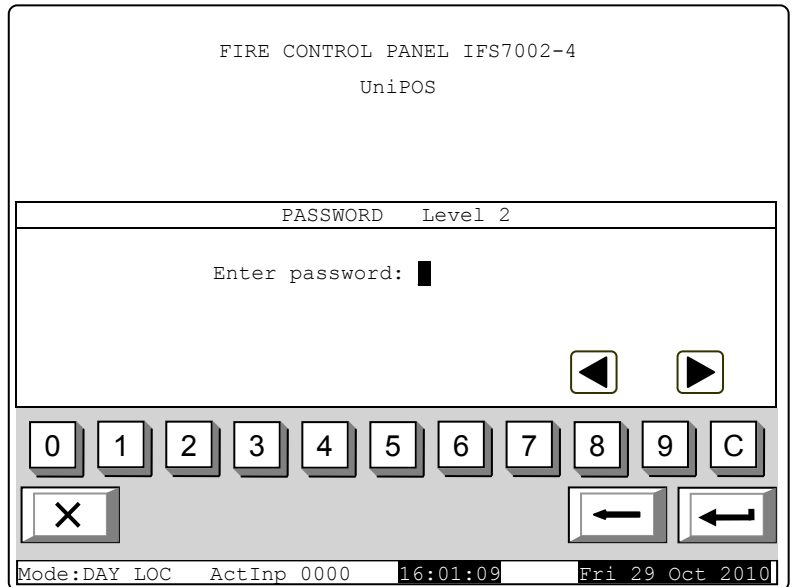

### 12.3.1. Menu *Disables*

The menu is provided for disabling fire alarm zones, addressable devices and monitored outputs of the control panel. It contains the following subordinate menus:

- Menu *Zones* – provided for disabling fire alarm zones;
- Menu *Devices* – provided for disabling addressable fire detectors;
- Menu *Outputs* – provided for disabling outputs – monitored outputs and addressable output modules.



#### 12.3.1.1. Menu *Zones*

Enter the menu to disable or enable fire alarm zones. Two screens are available here:

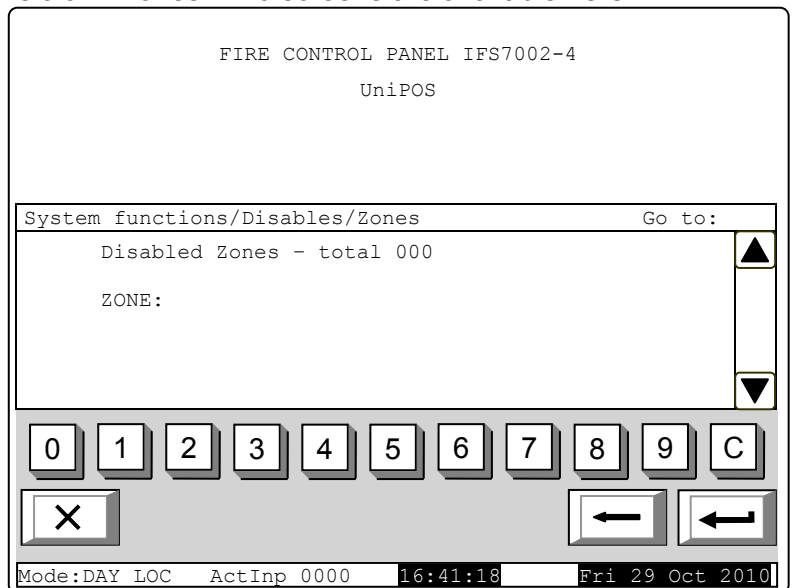
- If no disabled zones are available:



- If disabled zones are available – the first disabled zone is displayed, and in the bottom section of the panel appears text message for the zone:

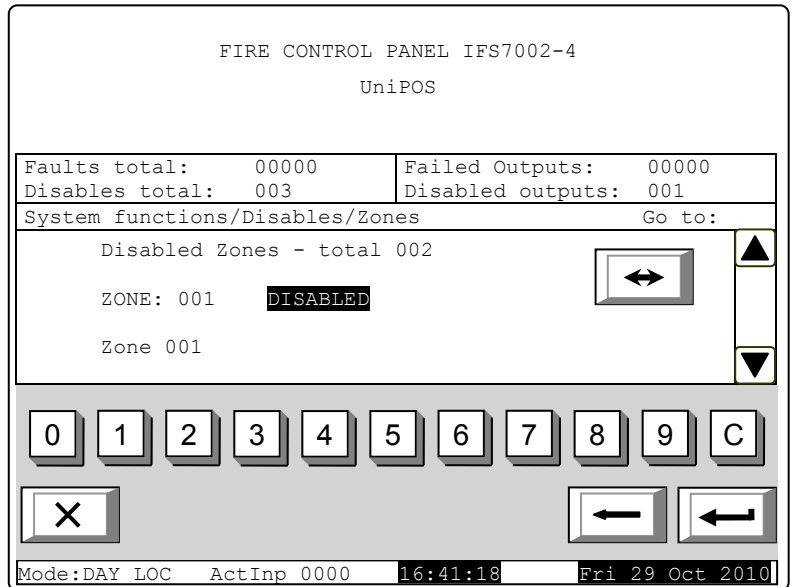

Buttons  and  in the right panel section allow the user to switch between the next disabled zone and the previous disabled zone (if any).

Using the digit buttons you may enter in the *Go to* field a random 3-digit number for a fire alarm zone. To edit the number press button , and the last entered digit will be deleted.



When you press button  after a number is entered in the *Go to* field, the status of the zone whose number is selected will be displayed:

- If the selected number is 0, the status of Fire alarm zone 1 will be displayed;
  - If the selected number is higher than 250, the status of Fire alarm zone 250 will be displayed;
  - If the zone has not been shaped yet, instead of text message for the zone appears *Free zone*.
- Simultaneously, the number on the *Go to* field is deleted, i.e. the field is deactivated.

When you press button  the fire alarm zone status is being changed alternatively from *DISABLED* to *ENABLED* and reverse; in the panel bottom left section appears a reminder *Data not saved*. Changes (disable/enable zone) are accepted if you press button  and the *Go to* field is empty – then the reminder *Data not saved* disappears.



12.3.1.2. Menu *Devices*

The menu is provided to disable and enable addressable fire detectors. It contains two submenus, having similar layout – for Loop 1 and for Loop 2; enter the submenus to display one of the following screens:

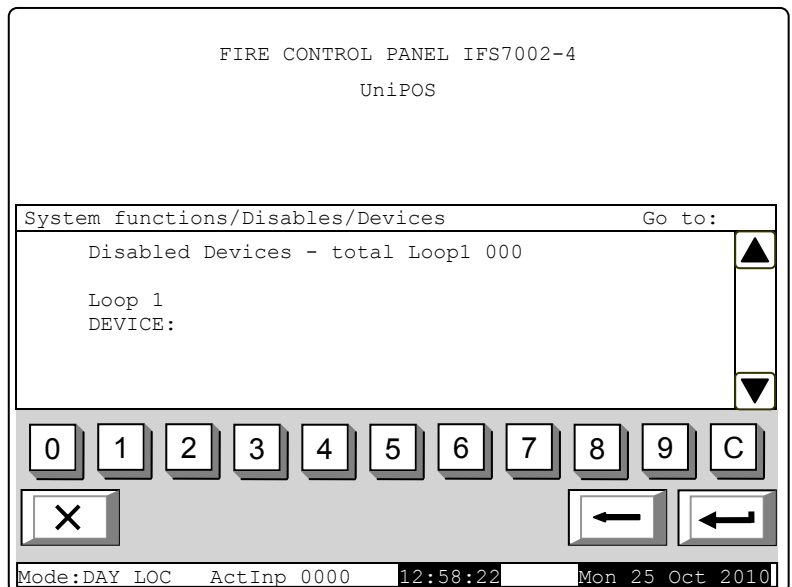
- If no addressable detectors are available:





- If disabled addressable detectors are available – the first disabled fire detector, and in the bottom section of the panel appears the detector’s text message:

Buttons  and  seen in the right panel section allow the user to switch between the next and the previous disabled addressable fire detector (if any).

Using the digit buttons you may enter in the *Go to* field a random 3-digit address for a device in the loop.

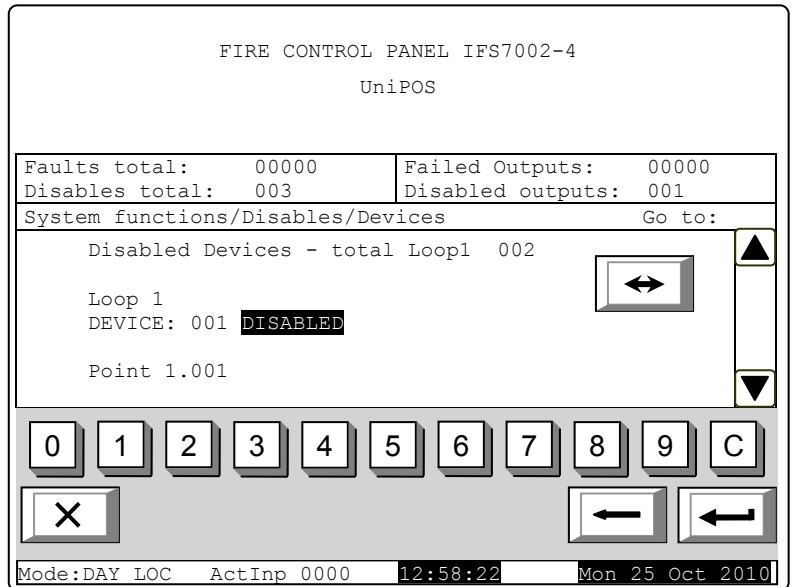
To edit the number press button  and the last entered digit will be deleted.



When you press button  after a number is entered in the *Go to* field, the status of the addressable fire detector whose number is selected, will be displayed:

- If the selected number is 0, the status of Device 1 will be displayed;
- If the selected number is higher than 125, the status of Device 125 will be displayed.

Simultaneously, the number in the *Go to* field will be deleted; i.e. the field is deactivated.

When you press button  the detector status is being changed alternatively from *DISABLED* to *ENABLED* and reverse; in the panel bottom left section appears a reminder *Data not saved*.



Changes (disable/enable addressable fire detector) are accepted if you press button  and the *Go to* field is empty – then the reminder *Data not saved* disappears.

### 12.3.1.3. Menu *Outputs*

The menu is used for disabling and enabling outputs (monitored outputs and addressable output modules). It contains the following subordinate menu and functions:

- Monitored outputs;
- Addr Outputs Loop1;
- Addr Outputs Loop 2.

Upon activation of function *Monitored outputs* a screen displaying the status of the control panel’s monitored outputs appears. The monitored outputs could be disabled only from the menus of the local (base PC board) fire control panel. The fire control panel will not accept disabling command from the menu of „Rem#101” (loops PC board).

Buttons  and  appearing in the right panel section allow the user to switch between the first and the second monitored output.

When you press button  the monitored output status is being changed alternatively from *DISABLED*

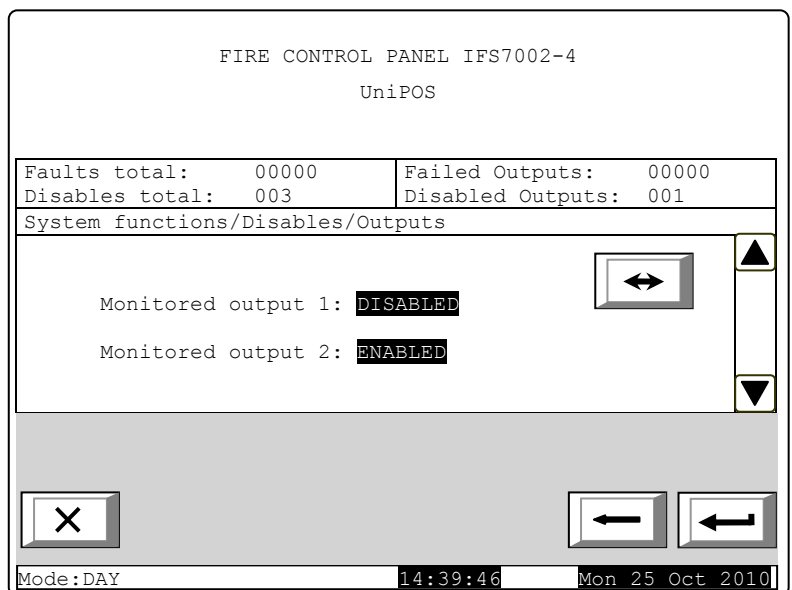

to *ENABLED* and reverse; in the panel bottom left section appears a reminder *Data not saved*. Changes (disable/enable addressable monitored output) are



accepted if you press button  and the *Go to* field is empty – then the reminder *Data not saved* disappears.

Menus *Addr Outputs Loop1* and *Addr Ouputs Loop 2* have identical layout. Enter the menus to display one of the following screens:

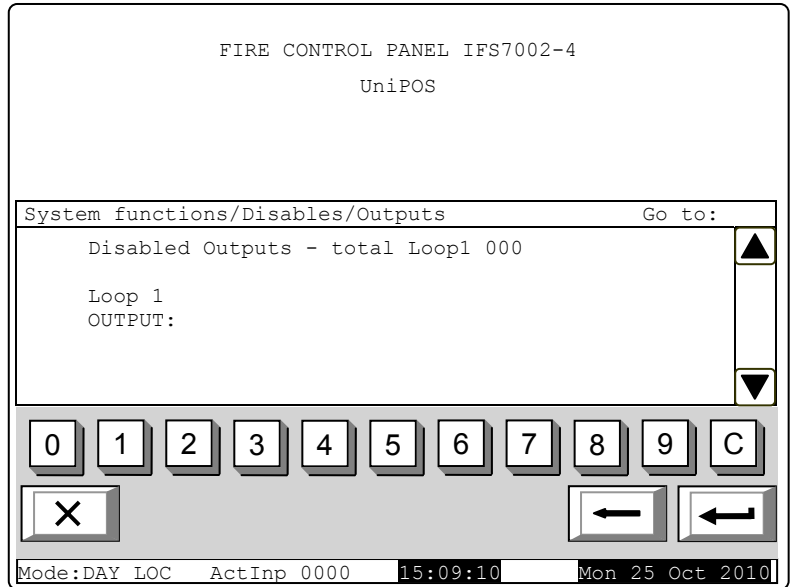
- If no disabled addressable output modules are available:





- If disabled addressable output modules are available – the first disabled addressable output module will be displayed, and the text message for the device will appear in the panel bottom section:

Buttons  and  seen in the right panel section allow the user to switch between the next and the previous disabled addressable output module (if any).

Using the digit buttons you may enter in the *Go to* field a random 3-digit address for the module in the loop. To edit the number press

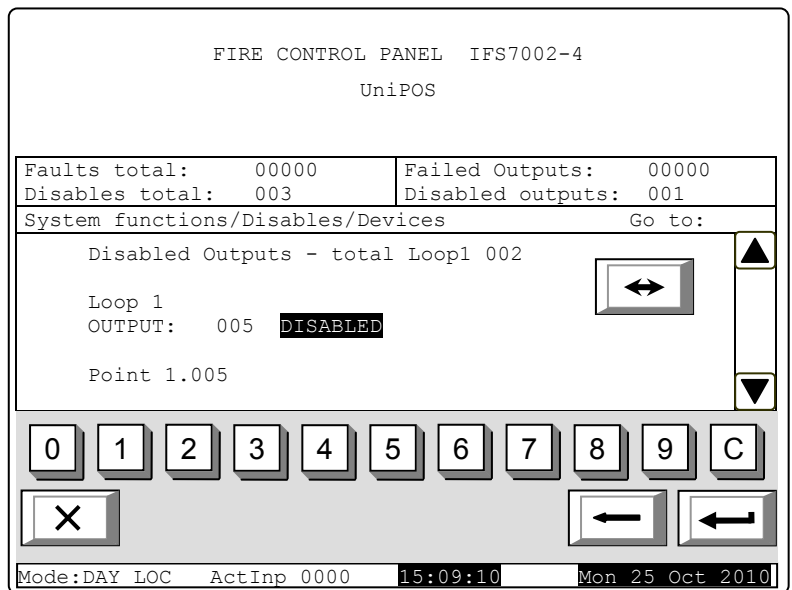
button  and the last entered digit will be deleted.



When you press button  after a number is entered in the *Go to* field, the status of the addressable output module whose number is selected, will be displayed:

- If the selected number is 0, the status of Device 1 will be displayed;
- If the selected number is higher than 125, the status of Device 125 will be displayed.

Simultaneously, the number in the *Go to* field will be deleted; i.e. the field is deactivated.

When you press button  the addressable output module status is being changed alternatively from *DISABLED* to *ENABLED* and reverse; in the panel bottom left section appears a



reminder *Data not saved*. Changes (disable/enable addressable output module) are accepted if you press button  and the *Go to* field is empty – then the reminder *Data not saved* disappears.



12.3.2. Menu *Zones in Test*

The menu is used to enable or disable test operation in fire alarm zones. Enter the menu to display one of the two screens:

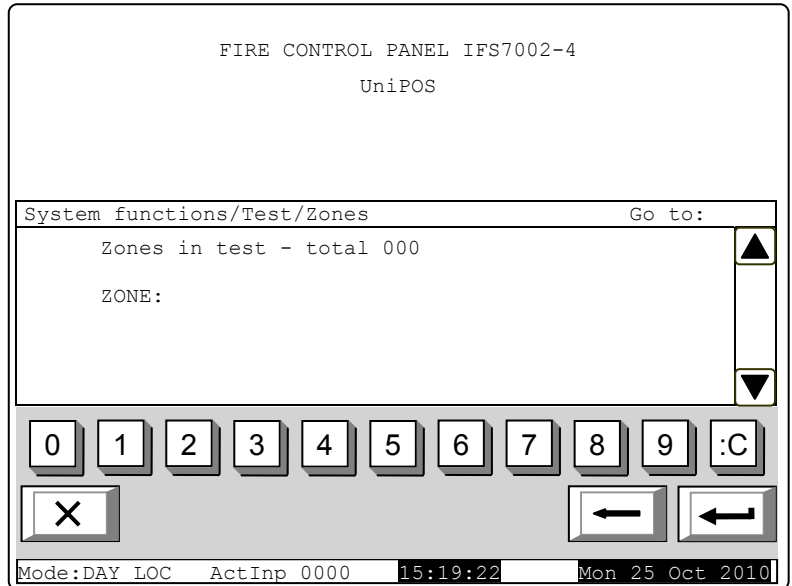
- If no zones in test are available:



- If some zones in test are available, the first zone in test will be displayed, and in the panel bottom section will appear the text message of the zone:

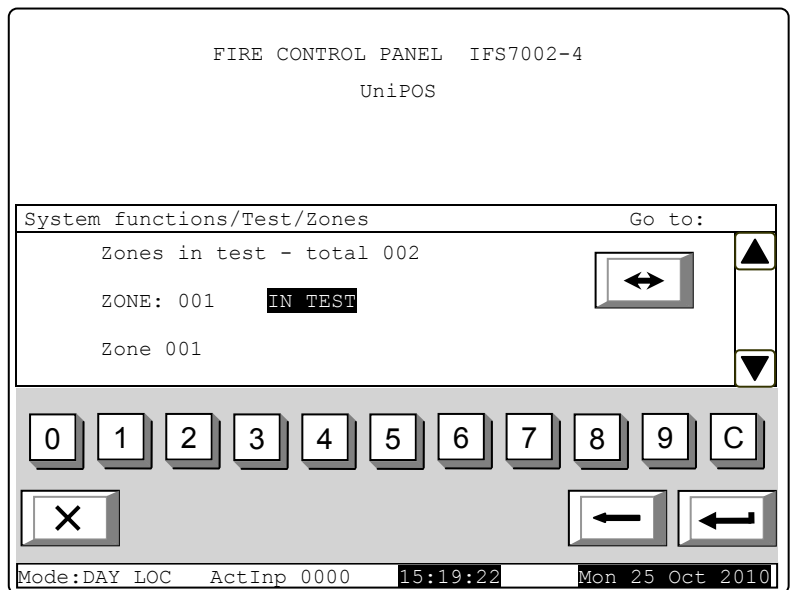

Buttons  and  seen in the right panel section allow the user to switch between the next and the previous zone in test (if any).

Using the digit buttons you may enter in the *Go to* field a random 3-digit number of the zone. To edit the number press button  and the last entered digit will be deleted.



When you press button  after a number is entered in the *Go to* field, the status of the zone whose number is selected, will be displayed:



- If the selected number is 0, the status of Zone 1 will be displayed;
  - If the selected number is higher than 250, the status of Zone 250 will be displayed.
  - If the zone has not been formed yet, instead of text message of the zone appears *Disabled zone*;
  - If the zone has not been formed yet, instead of text message of the zone appears *Free zone*;
- Simultaneously, the number in the *Go to* field will be deleted; i.e. the field is deactivated.

By pressing the button  the zone status is alternatively changed from *IN TEST* to *NOT IN TEST* and reverse, and in the bottom left section appears the reminder *Data not saved*. The changes (enable/disable test operation in fire alarm zone) take effect if button  is pressed (and the *Go to* field is empty); then the reminder *Data not saved* is cleared.



### 12.3.3. Function *Set Clock*



The function is used to set the real time clock of the control panel to the correct time. Enter the function to display the screen:



Calendar date, day of the week, the time and the value of the calibration index are visualized, as per the moment when the function was activated. The cursor is located over the first position in the first line (Date).

Buttons  and  in the right panel section allow the user to move between the lines on the screen.

To set the correct date and time (line one and three) use:

- The digit buttons – to enter a specific digit on the position of the cursor;
- Buttons  and  – to move the cursor one position to the left or one position to the right.

To set the current day of the week (line two) use buttons  and  – they will display the previous or the next day of the week. Moving from Monday to previous day will set the day to Sunday; moving from Sunday to next day will set the day to Monday.

The calibration index (line four) can be edited using buttons  and  – respectively decreasing or increasing the index by a single calibration device until the minimum or maximum value is reached (–30 / +30). Each positive device accelerates the clock at the rate of 10,7s per month; each negative device delays the clock at the rate of 5,35s per month. The maximum rate is e +5,5min per month or -2,75min per month.

While changing the values in the bottom left section appears the reminder *Data not saved*.

Changes take effect when you press button , then the reminder *Data not saved* is cleared.

Use this function to enter the same parameters for day, date and time for both PC boards of the fire control panel – the local fire control panel (base PC board) and the remote fire control panel Rem #101 (loops PC board). If the entered parameters differ then the records of the events in the archive will be registered at the time setup in the respective fire control panel.

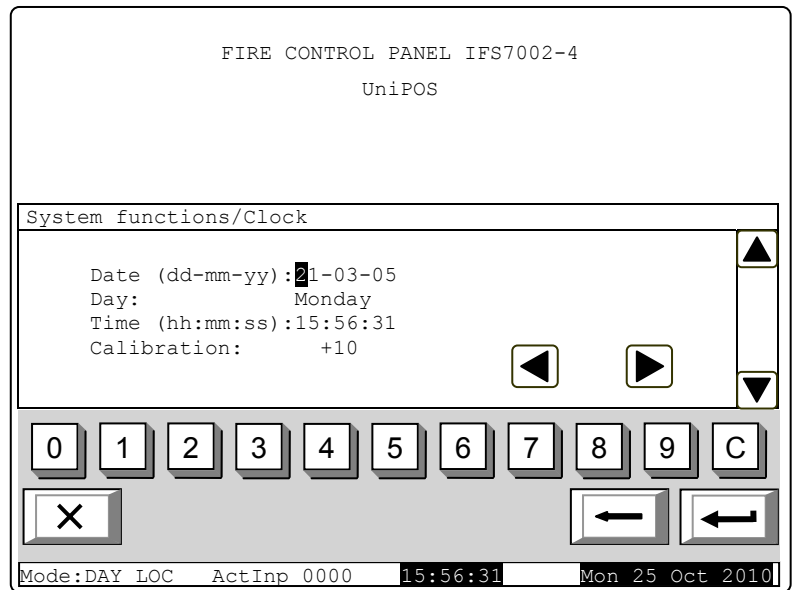

### 12.3.4. Function *Set Mode*

The function allows the user to set the mode of operation of the fire control panel (Mode:DAY or Night Mode). While operating in Night Mode, the control panel ignores Fire condition stage I (Phase 1 of fire condition); i.e. upon activation of automatic fire detector and manual activation of manual call point, the control panel will always enter Fire condition stage II (Phase 2 of fire condition).



Enter the menu to display the screen:

The current mode of operation is displayed in inversive colours – white letters on black background.

Buttons  and  in the right panel section allow to alternatively change the mode of operation.

When the mode is changed, in the bottom section appears the reminder *Data not saved*.

Changes take effect when you press button , then the reminder *Data not saved* is cleared.

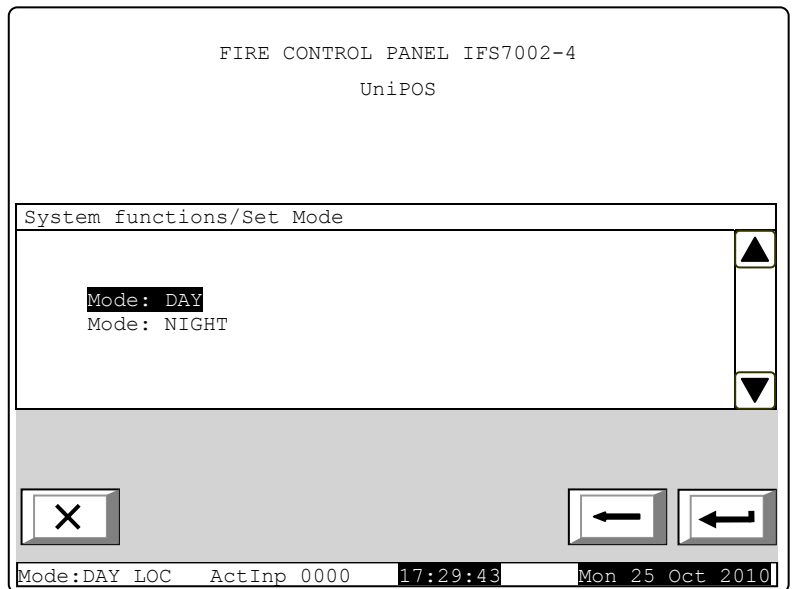



The setting of the function DAY/NIGHT must be the same for both fire control panels (Local and Rem #101). If the setting of REM #101 is NIGHT, and of the Local one – DAY, then if an event is registered for activation of manual call point from a zone in Rem #101 will make the fire control panel proceed as a whole to Fire condition phase-2.

### 12.3.5. Function *Check LEDs and Buzzer*



The function allows checking the LEDs and the local sounder.

The function is valid only for the local fire control panel. Enter the function to display the following screen:

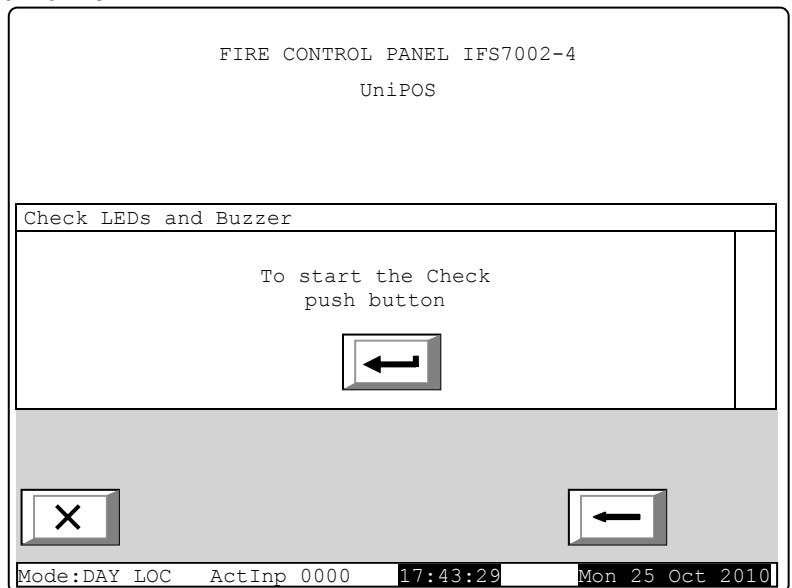
When you press button  which is in the middle of the display, the check-up operation starts – control panel's LEDs illuminate and the local sounder produces a continuous sound. The text message on the display changes: *To stop the Check push button* .



Press the button  once again to discontinue the check-up operation; the LEDs and the local sounder restore their initial state.

The operation of buttons  and  is extended – except for the basic functions they also discontinue the check-up if it has been started.



Note: LED  *System Error* and the local sounder are activated or deactivated a few seconds later than the rest of the LEDs.

If the function is started from a menu in loops PC board a text message appears on the screen: **This function is possible ONLY for the LOCAL fire control panel**

## 12.4. Menu Set Up



This is the menu for Set Up condition (see section 13).

Access to Set Up menu is allowed at Access Level 3A; accordingly as soon as you enter the menu, a password screen appears:

To enter the password use the digit buttons – press a button and the relevant digit will be inserted in the place pointed by the cursor „█“, and the previous text and the cursor itself move one position to the right. Move the cursor to the right or to the left using buttons  and . Press button  to delete:

- The digit under the cursor, if any;
- The digit to the left of the cursor if no digit is under the cursor.

Password maximum length is 10 symbols. If you press a digit button after a 10-symbol password is already entered, the extra digit is not accepted.

If the password is not correct, when you press button  all digits are deleted and the cursor moves back to initial position. If a password for Access Level 3 is entered, press button  and the fire control panel enters Set Up mode: fire detectors are being reset, monitored and addressable outputs are being switched off and the faults are being cleared. During this operation the message *Please wait* appears on the screen; as soon as the operation is completed, the menu Set Up is activated.

In case an external keyboard has been connected before entering the SetUp Menu, the set up of the fire control panel can be done via the keyboard.

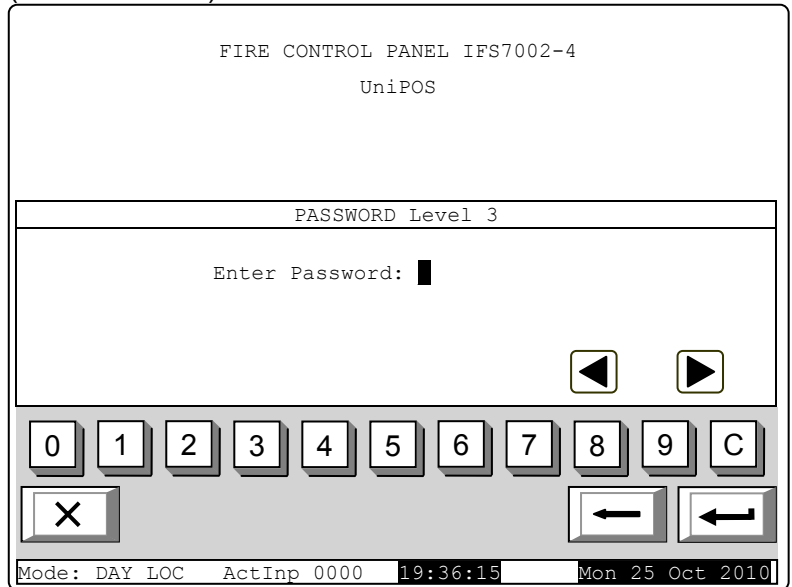

## 13. Set Up Mode







### 13.1. Description



Set Up mode is used for setting the configuration parameters of the control panel.

Access to the Set Up screen is provided through *Information and Control Mode* – submenu Set Up (see section 12.4).

When the control panel enters Set Up mode, it exits all other conditions and discontinues the service of fire alarm zones, addressable devices, monitored outputs and other periphery devices (all outputs are switched off). The panel can be controlled via the keypad provided for the purpose. Upon exit of Set Up mode, reset of the control panel is performed.



In Set Up mode only the green LED indicator  (*Power supply*) is illuminated. The local sounder is off.

The displayed screens have a tree structure of subordinate menus (Appendix 2b). Transition to a lower hierarchy menu is performed via button  (*Enter*); to revert to a previous/ upper hierarchy menu use button  (*Cancel*). To move between elements of a single menu use buttons  (*Up*) and  (*Down*) – when the menu appears as ascending window from the left bottom corner of the screen, or buttons  (*Move Up*) and  (*Move down*) – when the menu appears on a panel in

the middle of the screen. To exit the condition use button  (*Exit*) or press repeatedly button  (*Cancel*) until you reach the main menu.

The screens provided for parameter changes and command execution (command screens) are of the lowest hierarchy. When a screen for parameter changes is activated, a pointer indicating the current parameter, subject to changes, appears. The pointer may be visualized as:

- a cursor, indicating the position where:
  - ◆ a symbol will be inserted – if there is a symbol under the cursor and a text at the cursor's right side, they will be moved one position to the right;
  - ◆ a symbol will be deleted – if there is a symbol under the cursor, it will be deleted; the text at the right side will be moved one position to the left; if there is no symbol under the cursor, the symbol to the left will be deleted.
- an arrow, pointing over the parameter;
- a text in inverse colours.

To move between the parameters use buttons  (next parameter) and  (previous parameter). When a parameter is changed, in the bottom left section of the panel appears the reminder *Data not saved*. To save the changes press button  and the reminder *Data not saved* is cleared.

Menu Set Up contains the following subordinate menus and functions:



- Panel configuration;
- Panel parameters;
- Loops;
- Zones;
- Inputs;
- Initialization;
- Checks;
- New Passwords;
- Default parameters;
- Clear Archive.

### 13.2. Menu *Panel configuration*

The menu is used to set up:

- the local network where the control panel is included in:
  - ◆ the parameter Local network MUST be *On*.
  - ◆ if no local network is available, set the field to *Off* and the parameter will not be active;
- the periphery devices in the control panel: (both PC boards of the fire control panel will not communicate with each other!);
  - ◆ if periphery devices are present they can be switched on or off;
  - ◆ if no periphery devices are present, the message *None* appears in the field and the parameters remains inactive;
- the power loop – it can be switched *On* or *Off*;
- the language of the messages – language options are Bulgarian or English. The language of the menus depends on the setting in the local fire control panel (base PC board). The setting of the language in the remote fire control panel Rem#101 (loops PC board) effects only the language of the messages shown on the display.
- Check for earth – it can be switched *On* or *Off* the check for connection between the wires, which exit from the panel wires and grounded metal part or other wires.

The menu has the following layout:

The information for the first active parameter is displayed in inversive colours (white letters on black background). Buttons  and  at the right panel side allow the user to move between the active parameters only.

To edit the parameters use button  – each time you press it the parameter value changes to the next acceptable value.

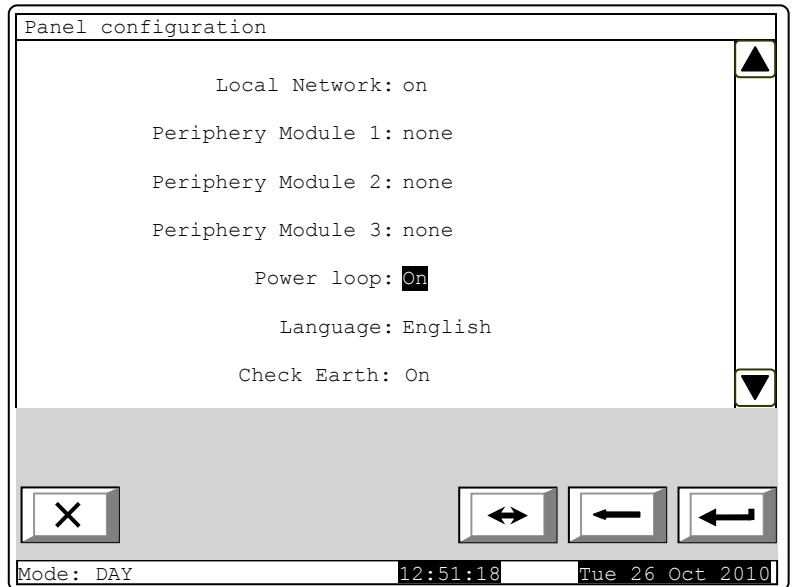

### 13.3. Menu *Panel parameters*

Use the menu when the control panel is integrated into a local network of panels (see Interactive Fire Control Panel IFS7002 – Operation in Local Network).

### 13.4. Menu *Loops*

The menu is provided for set up of fire alarm loops and devices integrated in the loops. It contains two submenus of identical layout – for Loop 1 and for Loop 2. Each submenu contains:

- Menu *Loop parameters*;
- Screen *List devices*
- Menu *Device parameters*;
- Function *Check up*;
- Function *Manual addressing*.

#### 13.4.1. Menu *Loop parameters*

The menu allows the user to adjust the parameters of the fire alarm loop:

- Loop status - *On* or *Off*
- Number of devices integrated in the loop;
- Addressing of the devices in the loop – *Automated* or *Manual*.

To correct Status and Addressing parameters, use button  – when pressed, the parameter value changes alternatively:

- for Status parameter – from position *On* to position *Off* and vice versa;

- for Addressing parameter – from position *Automated* to *Manual* and vice versa.

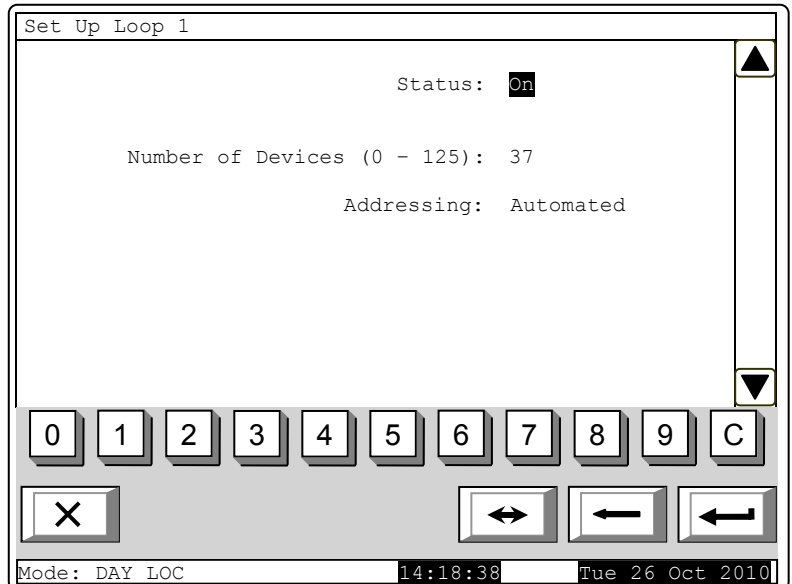

13.4.2. Screen *List Devices*

In order to use this function the loop has to be initialized. A list of the devices included in the selected loop with their type and respective number is shown on the screen.

*Example: Heat of rise fire detectors FD7110 – 3 pcs., heat differential FD7120 – 1 pc., manual call points FD7150 – 6 pcs. etc.*

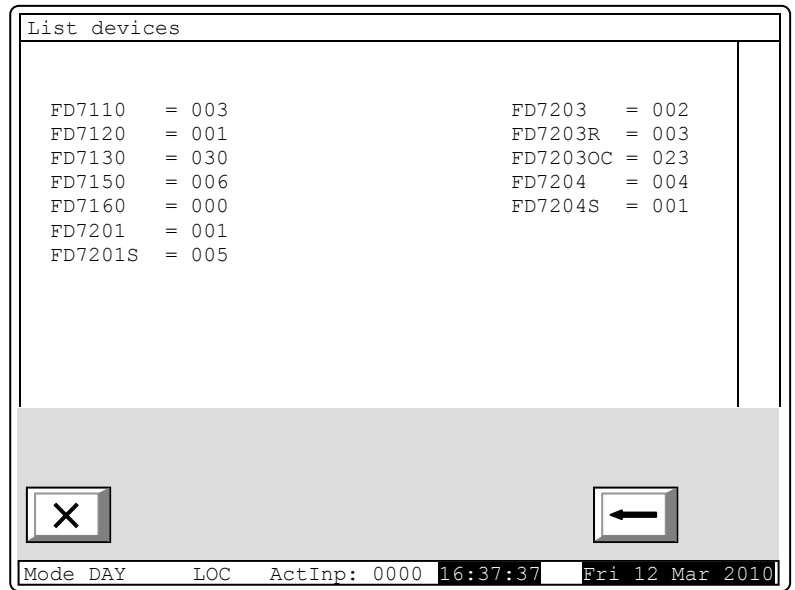

13.4.3. Menu *Device parameters*

The menu is used to set up the parameters of the devices integrated in the fire alarm loop. Enter the menu to display:

- If no devices are included in the loop – a screen with the message *No devices included*; the only option is to exit the menu;
- If some devices are included in the loop – a screen where you may select the device whose parameters are to be set up:

For each device are displayed:

- Its number (address) in the loop – in the top line;
- Text message – in the line beneath.

The current device is pointed by arrow – .

Buttons and at the right panel side are visualized if more than one device is available in the loop; the *Go to* field on the panel heading and the digit buttons appear if more than 7 devices are available in the loop. Press a digit button, the *Go to* field is activated and a random 3-digit address for each device in the loop can be entered.

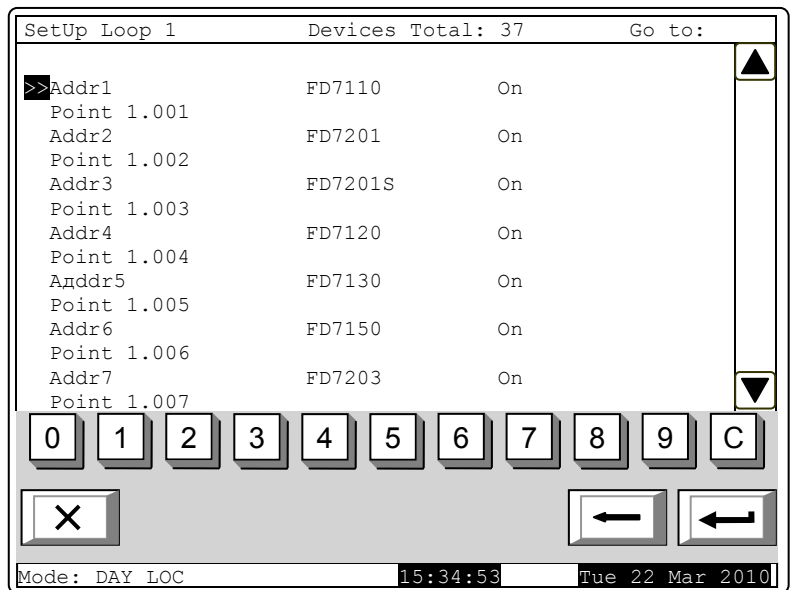

To edit the address use button ; press it and the last entered digit will be deleted.

Press button after you entered a number in the *Go to* field; then the device whose address is in the field will be selected:

- If the number is 0, the device having address 1 will be selected;
- If the number is higher than the actual number of devices in the loop, the device having the highest address number will be selected

Simultaneously, the number in the *Go to* field will be deleted, i.e. the field is deactivated.

Press button after you entered a number in the *Go to* field and the field will be deactivated.



Press button  when the *Go to* field is empty and a menu containing a group of parameters for the selected device will be displayed:

- Menu *Device parameters*;
- Screen *Text message*.

13.4.3.1. Menu *Device parameters*

The menu is used for addressable device parameters set up:

- Device temperature class – only for addressable devices type FD7110, FD7120, FD7130, FD7160 and FD7201;
- Device status – *On* or *Off*.

As a heading is displayed the type of the device:

To edit the parameters use button  – press it to change the parameter to the next acceptable value.

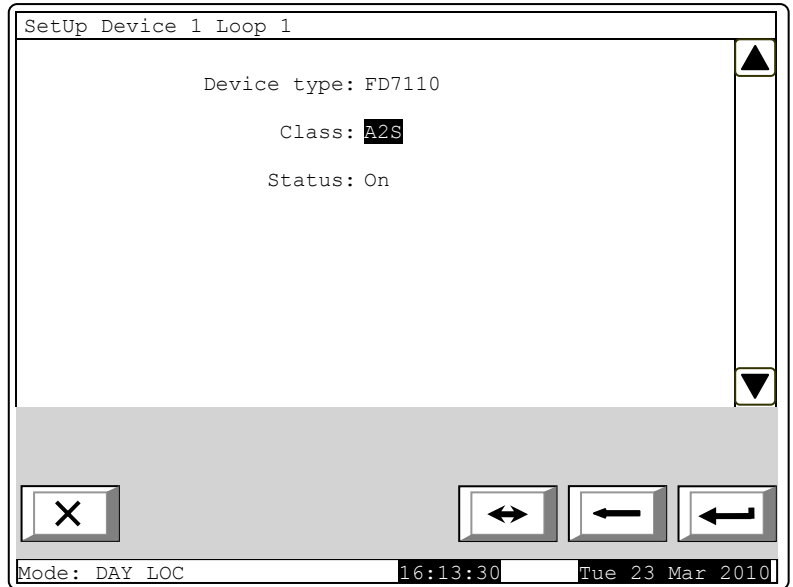

---

If FD7201 or FD7201S device is setup it could be configured to be utilized as a conventional line-monitoring module or a monitored input. Enter when the activated input has to be reset and the activated outputs to be turned off after the input action on the input has ceased if it is an input.

---

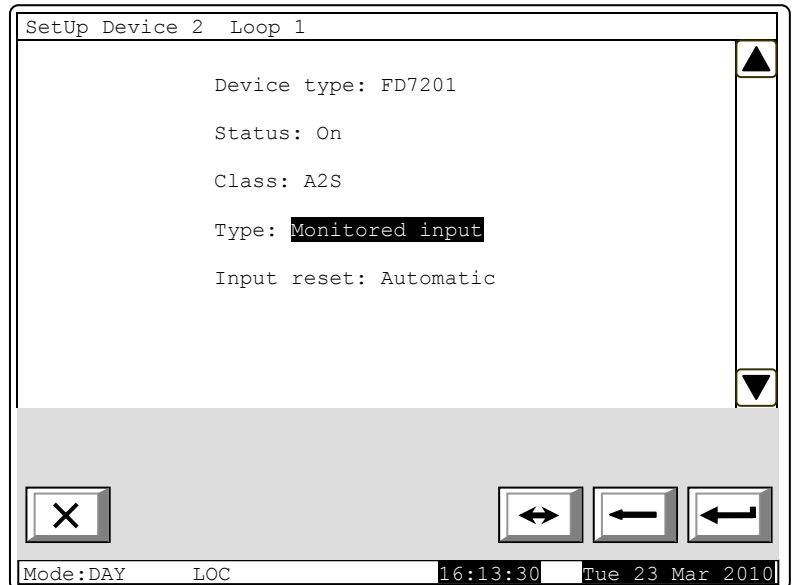

---

The following screen is displayed if FD7201 is used as a conventional line-monitoring module.

---











Programming the outputs of addressable executive device FD7203 (ver.12 and next)

Program the outputs of FD7203 device in menu *Setups/Loops/Device Parameters*.

The active buttons in the screen are:

- button  (Enter);
- buttons  (Move Down) and  (Move UP)
- button  (Change);
- button  (Cancel);
- button  (Exit).

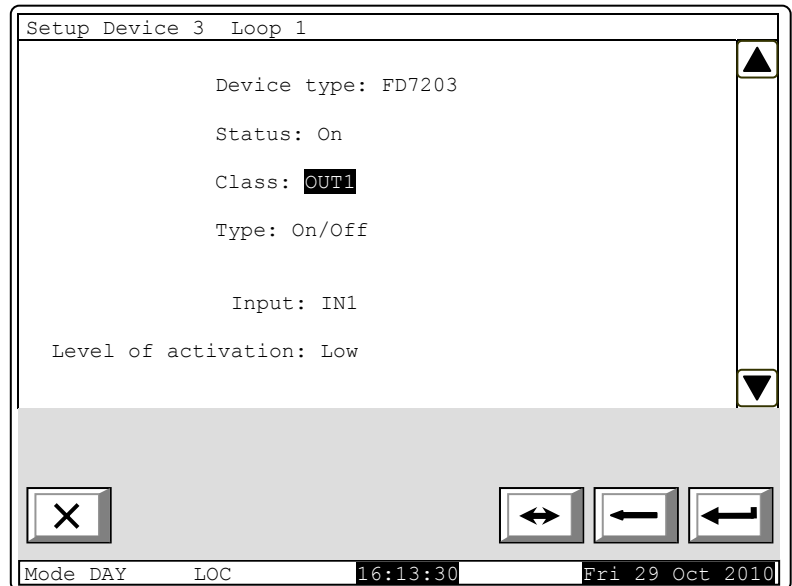

When a device of FD7203 type is selected the following screen appears.

The device is specified by the following parameters:

- Type of the device;
- Status (on/off);
- Output
- Type of the output signal (table 3)
- Input
- Level of activation (table 4)

When the device FD7203 is changed the new device should be given the same settings so that the programmed output signals are preserved.

**Table 3**

	Type of the output signal	Formed output signal	Description of the output signal
1	OFF/ON	Continuous output signal	When an event occurs the output is activated. It remains in this condition until a reset command is sent from the

			fire control panel or a signal for switching the output off.
2	OFF/ON +Time delay	Continuous output signal with programmed time delay for the output activation	Upon receiving a signal for activation the device starts the waiting time setup in advance in the screen and after it expires, the output is activated. It remains in this condition until a reset command is sent from the fire control panel or a signal for switching the output off.
3	Inverse OFF/ON	Inverse switching on of the output and continuous output signal	The same as case 1, but with inverse action: <ul style="list-style-type: none"> <li>– in Duty Mode the relay is ON. It is switched off when a command for activation is sent;</li> <li>- the open collector in Duty Mode supplies 24V DC. Upon activation - 0V DC.</li> </ul>
4	Inverse OFF/ON + Time delay	Inverse switching on of the output and continuous output signal with programmed time delay for the output activation	The same as case 2, but with inverse action: <ul style="list-style-type: none"> <li>– in Duty Mode the relay is ON. It is switched off when a command for activation is sent;</li> <li>- the open collector in Duty Mode supplies 24V DC. Upon activation - 0V DC.</li> </ul>
5	Pulse	Pulse signal	The output is activated for preliminary setup time by the user (pulse width). After it expires the output is reset without a signal to be required from the fire control panel.
6	Pulse + Time delay	Pulse signal with programmed time delay for the output activation	The output is activated for preliminary setup time by the user (pulse width), after the entered time delay has expired. The activation is only one-time for the received input signal. The output is reset without a signal to be required from the fire control panel.
7			The signal from the activated output is a pulse sequence with width programmed by the user.

	Pulse sequence	Pulse sequence	The output remains in this condition until a reset command is sent from the fire control panel or a signal for switching the output off.
8	Pulse sequence + Time delay	Pulse sequence with programmed time delay for the output activation	<p>The signal from the activated output is a pulse sequence with width programmed by the user.</p> <p>The output sends the described signal after the entered time delay has expired.</p> <p>The output remains in this condition until a reset command is sent from the fire control panel or a signal for switching the output off.</p>

**Table 4**

	Level of input activation	Description
1	Low	In Duty Mode the voltage supplied at the input is within the range (5 – 30)V DC. When the voltage reaches the ranges of (0 -1)V DC, information is transmitted to the fire control panel for activation of the input that causes activation of the outputs assigned to that input.
2	High	In Duty Mode the voltage supplied at the input is within the range (0 – 1)V DC. When the voltage reaches the ranges of (5-30)V DC information is transmitted to the fire control panel for activation of the input that causes activation of the outputs assigned to that input.

#### 13.4.3.2. Screen *Text message*

The screen is used to assign and edit text messages for each addressable device. Upon activation of the screen a check up for available external keyboard is performed.

##### 13.4.3.2.1. Built-in keypad

If no external keyboard is integrated in the control panel, the following screen appears:

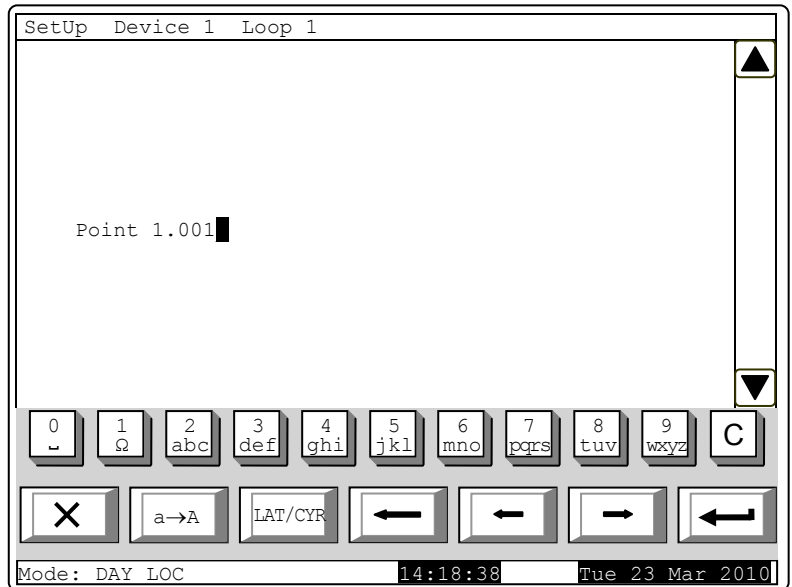





To edit the text use the buttons having symbols – when you press a button, the symbol appears over the position of the cursor, and the previous text is moved one position to the right. The cursor remains for 1 s over the same position; if you press it again, the symbol will be changed by the next one marked on the button (the symbol Ω marked on the second button means, that the figure 1 is in combination with punctuation marks). 1 s after the last pressing the cursor moves to the next position to the right.



If you press another button during this 1 second, the cursor first moves one position to the right and then the new symbol is inserted. The maximum length of the message is 40 symbols. If you press a button after a 40-symbol message is already entered, the text will not be accepted and the symbol will not be inserted (the cursor moves one position to the right if the end of the text message is not reached yet).

Press button  to delete:

- The symbol under the cursor, if any;
- The symbol to the left of the cursor, if there is no symbol under it.

Press button  or  to move the cursor one position to the left or to the right.

Button  changes the case from lowercase to uppercase, button  changes the uppercase to lowercase.

Button  changes the Latin font to Cyrillic font; button  changes the Cyrillic font to Latin font.

### 13.4.3.2.2. External keyboard

If an external keyboard is included to the fire control panel the following screen appears:

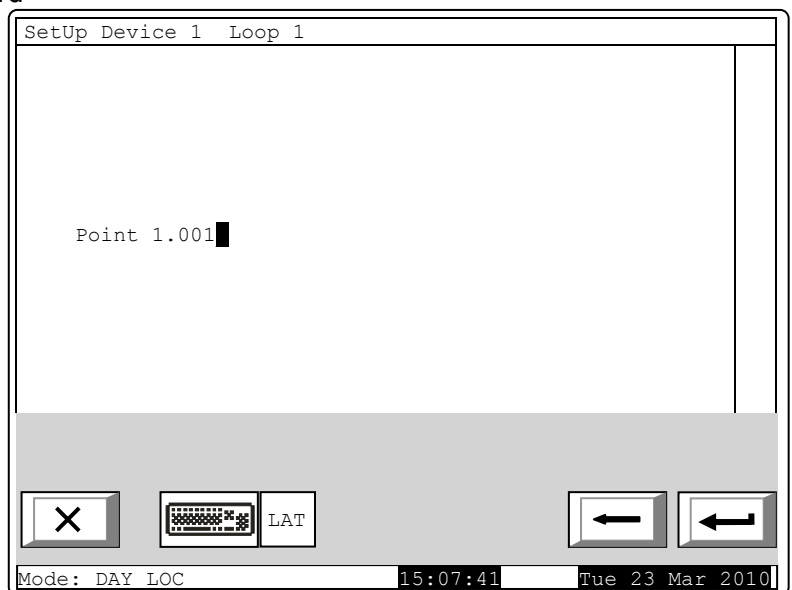



To edit the text use the buttons having symbols – when you press a button, the symbol appears over the position of the cursor, and the previous text and the cursor move one position to the right



The maximum length of the message is 40 symbols. If you press a button after a 40-symbol message is already entered, the text will not be accepted and the symbol will not be inserted

Press button „Delete” to delete:

- The symbol under the cursor, if any;
- The symbol to the left of the cursor, if there is no symbol under it.



Press button  or  to move the cursor one position to the right or to the left.

Use the additional digit keypad to:



- Insert digits – when the LED „Num” is illuminated;
- Move the cursor via buttons „4 / ←” and „6 / →” (analogically to buttons  and ) – when the LED „Num” is extinguished;
- Delete a symbol via button „Del” (analogically to button „Delete”) – when the LED „Num” is extinguished.

The mode of operation of the additional keypad, indicated by the LED „Num” can be changed via button „Num Lock”.

Button „Caps Lock” alternatively changes the case from lowercase to uppercase (LED „Caps” or „A” illuminate to indicate uppercase).

Button „Ctrl” alternatively changes Latin fonts to Cyrillic fonts; the active font is indicated in the bottom section of the display – indicators  and .

To save a text message press button  on the built-in keypad or press button  („Enter”) on the external keypad.

To exit the screen and revert to upper hierarchy menu use button  on the built-in keypad or button  („Back Space”) on the external keypad.

To exit Set Up use button  on the built-in keypad or button „Esc” on the external keypad.

13.4.4. Function *Check up*

The function is used to check the fire alarm loop against the requirements for automated addressing (see section 6.4.1.).

A warning screen is displayed when the function is activated:

(during check up the devices receive random addresses; due to that reason the loop is switched off when the function is exited; i.e. when switched on again, the loop will not be initialized.)

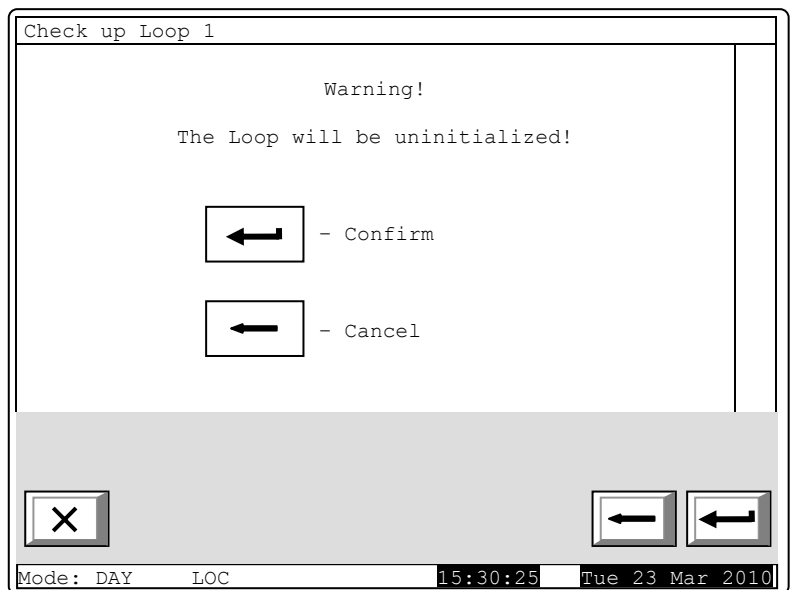

When check up is started via button , the display is cleared and a text is seen in the centre: Please wait...

After the loop is prepared for check up, the following screen is displayed:

The current number of detected devices and branches in the loop is displayed in the two bottom lines.

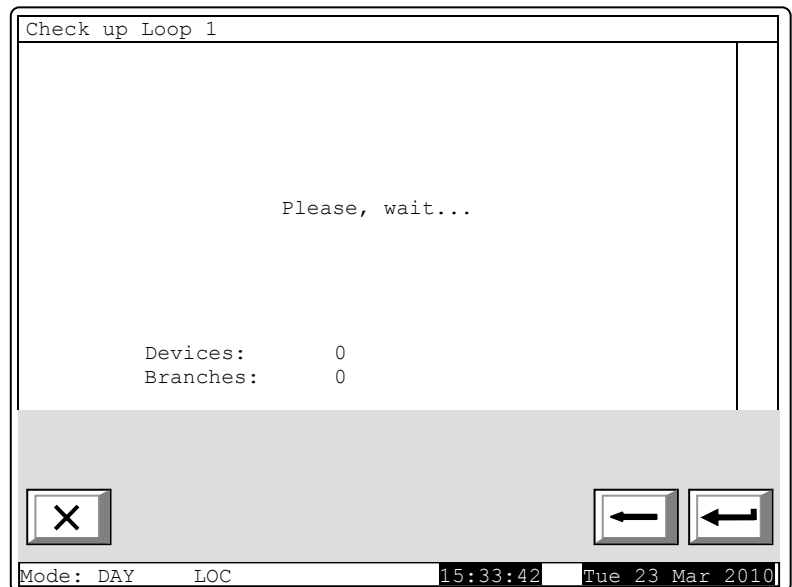

After check up is completed a screen with results is displayed:

In the centre of the screen results from the closed loop check up are displayed which can be:

- Straight loop;
- Short circuited loop – when short circuit occur in the loop between the fire control panel and the first/last device;
- A random combination of faults *Break in a loop*, *Excessive number of brunches in a point*, (more than one branch between two devices in a loop), *Excessive number of devices in a loop* (more than 125 devices in a loop) and *Fault in device NNN* (fault in communication with device with address NNN).

The number of detected devices and branches in the loop is displayed in the two bottom lines.

Additional information is provided by the devices in the loop:

- In case of straight and closed loop and branches, the LEDs of the last device illuminate with constant light;
- In case of break in wires of a closed loop or of a branch, the LEDs of the device located immediately before the break, illuminate with constant light;
- In case of short circuit in a closed loop (not near the fire control panel) or in a branch, the LEDs of the device located immediately before the short circuit start flashing.

After check u is completed, button  is still active – if pressed, it will start check up again.

When the function is exited via button  the loop is switched off and the devices' LED extinguish.

#### 13.4.5. Function *Manual addressing*

The function is intended to provide clean initialization of a fire alarm loop in case of manual addressing (see section 6.4.2.3.).

#### 13.4.5.1. Operation of *Manual addressing*

The function operates following the sequence below:

1. Check for availability of any devices in Service zone 0. If the zone is not empty, the following screen appears:

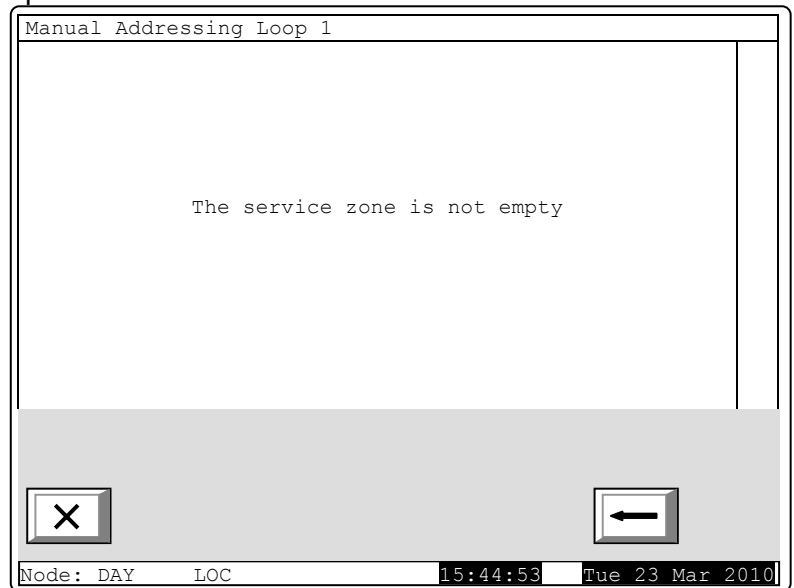

which allow for function exit only. In such case enter the Re-addressing Menu (see section 13.7.3.) and clear Service zone 0.

2. Display the function panel and in the centre the message *Please wait* is seen.
3. Check for short circuit or overload of the loop. Depending on the result one of the following screens will be displayed:

- ◆ In case of short circuit in both loop lines:

Only exit of the function is allowed. In this case the short circuit in the loop shall be fixed.

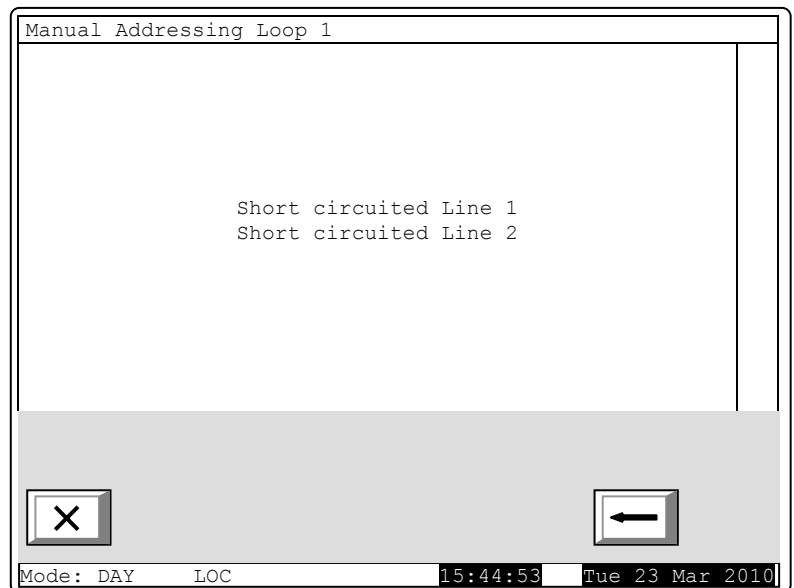

- ◆ In case of loop overload:

Only exit of the function is allowed. In this case the cause of overload shall be eliminated.

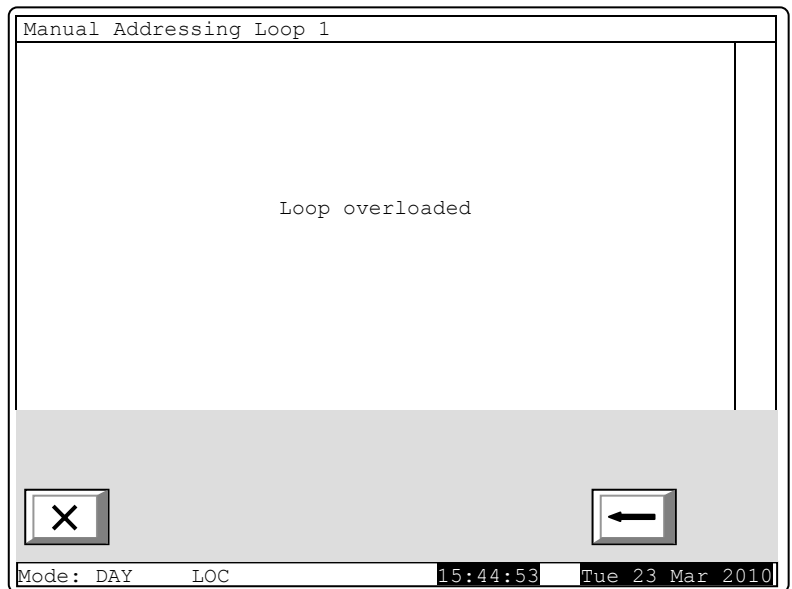

- ◆ In case of short circuit in one of the loop lines or in case of straight loop (the message in the bottom right corner appears in case of short circuit in one of the loop lines only):



4. Check for availability of any disabled devices. During the check in the bottom right corner is displayed the counter for devices (1 to 125). Where a disabled device is detected, a command for illumination of its LEDs is sent. Depending on the result of the communication with the device, one of the following screens appears:



4.1. In case of unsuccessful communication with the device:

Only exit of the function is allowed.

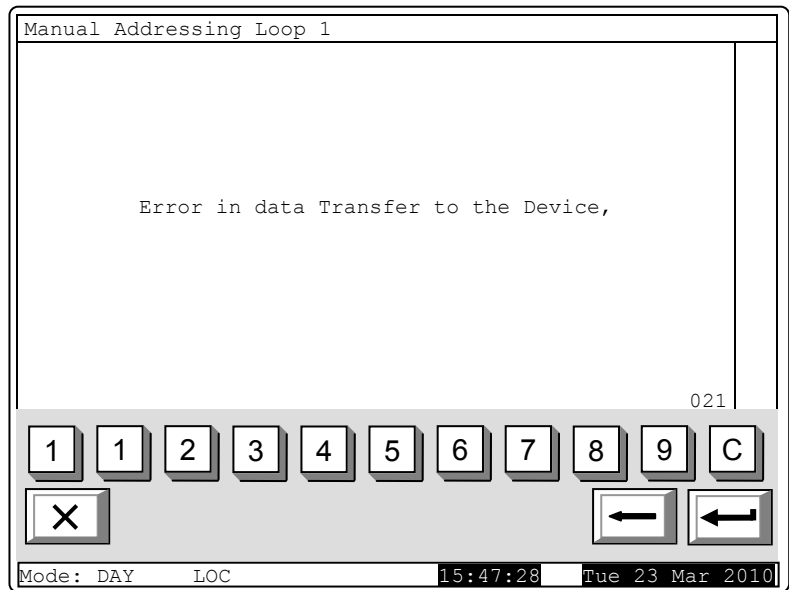

4.2. In case of successful communication with the device:

The device's address shall be entered on the screen, using the buttons with figures. Then, the *Status* line will indicate *On* or *Off* for the entered address. The desired address shall be confirmed with button  and the device will be initialized with this particular address.

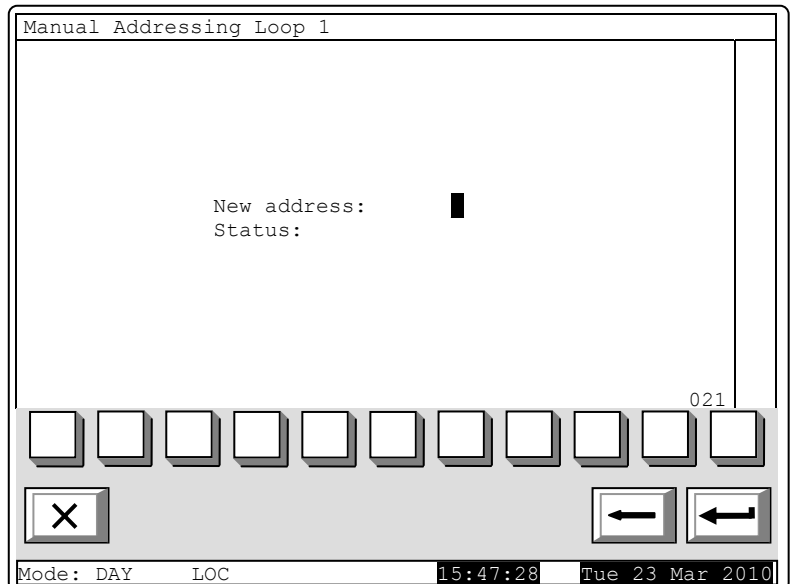

Depending on the device initialization result, one of the screens will be displayed:

- \* In case of unsuccessful operation a screen with the text *Fault in device communication* will appear, as in section 4.1.

- \* In case of detected devices with this particular address:

The device address shall be corrected in the screen using the buttons with figures.

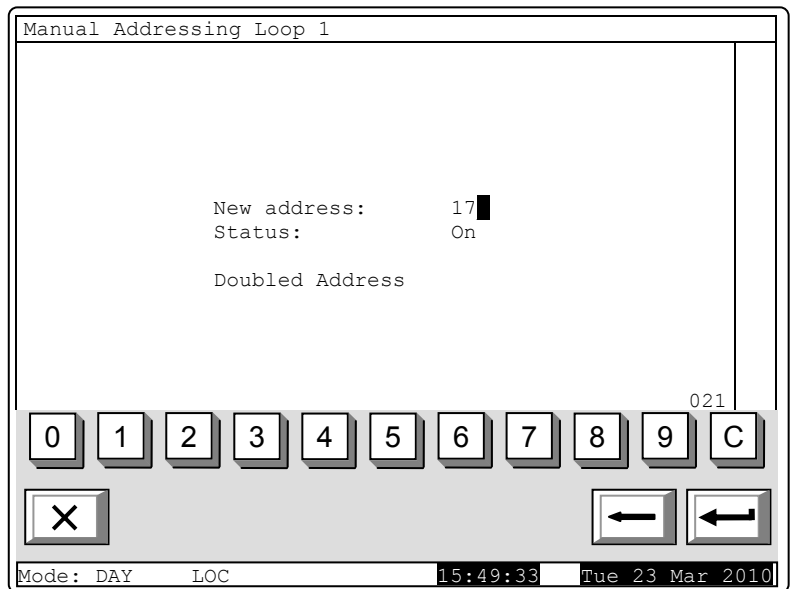

- \* In case no device has this address and the operation is successful, search for next disabled devices is proceeding.

5. Check for any uninitialized devices:

- 5.1. In case of short circuit in both lines or loop overload the following screen appears:

Only exit of the function is allowed. In this case the short circuit or the cause of overload shall be eliminated.

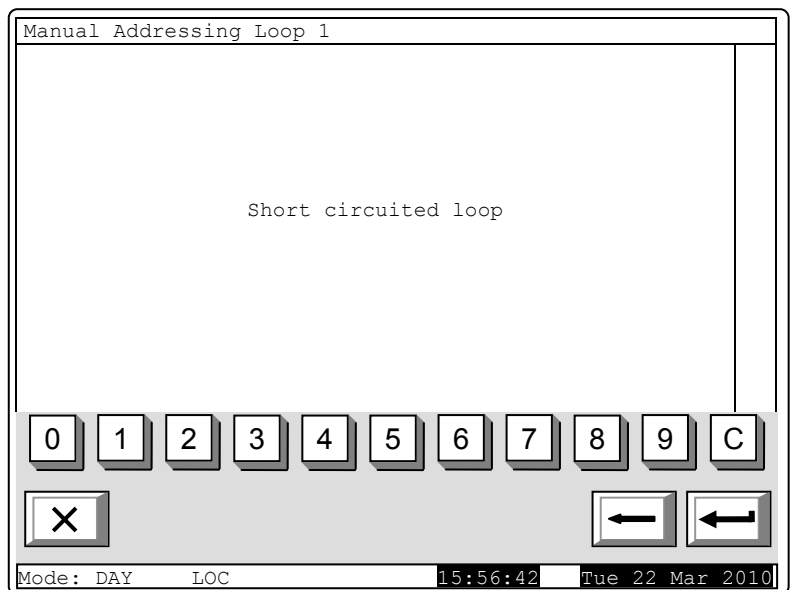

5.2. Where no uninitialized devices are detected appears the following screen:

The function is waiting for new device to be installed in the loop or to press button  to exit the function.



5.3. In case two or more uninitialized devices are detected in either of the loop lines, i.e. more than one branch exists at one point and devices without addressing are detected in more than two branches (in the loop and in more than one branch) the following screen appears:

In such case the number of uninitialized devices shall be reduced until the above set requirements are met.

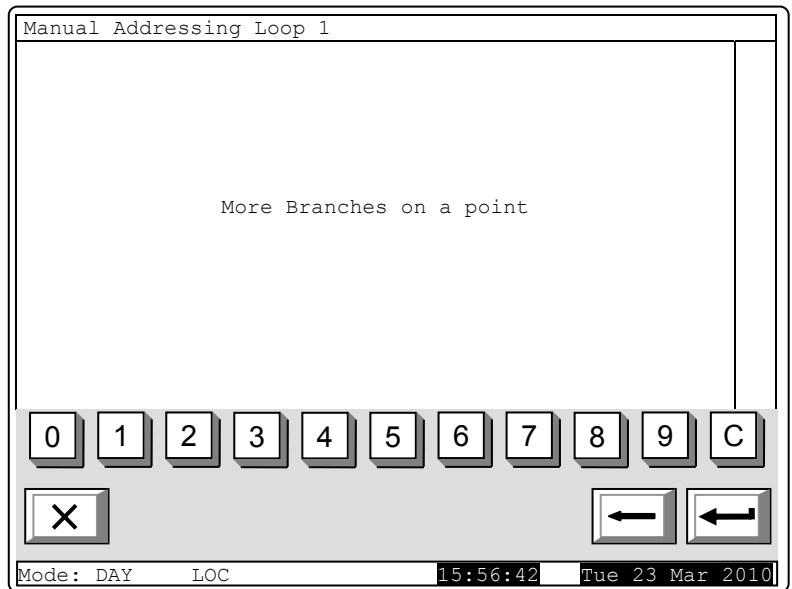

5.4. Where the provisions in sections 5.1, 5.2 and 5.3, are not met, a command for illumination of devices LEDs is sent to the uninitialized (or to one of the uninitialized) device. Depending on the result of the communication one of the following screens appears:

a) In case of unsuccessful device communication:

Exit of the function is allowed only.

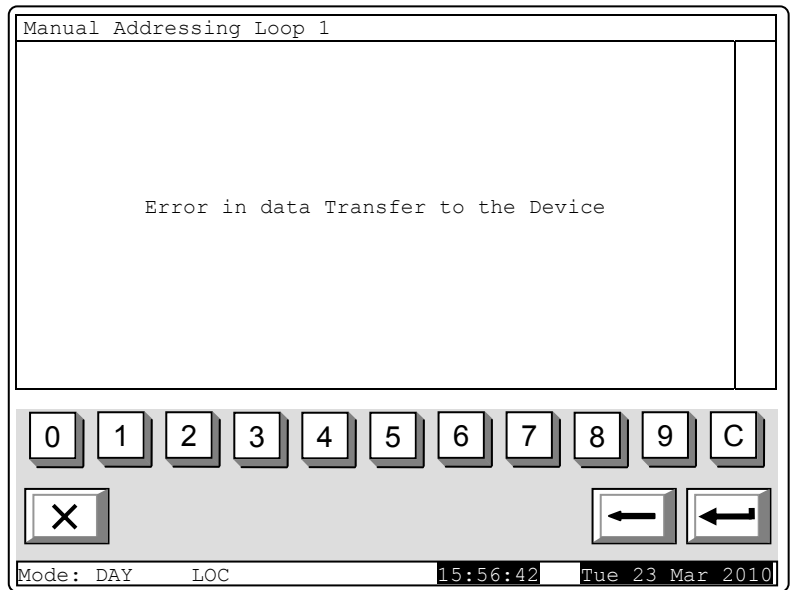

b) In case of successful device communication:

The device's address shall be entered on the screen, using the buttons with figures. Then, the Status line will indicate On or Off for the entered address. The desired address shall be confirmed with button  and the device will be initialized with this particular address

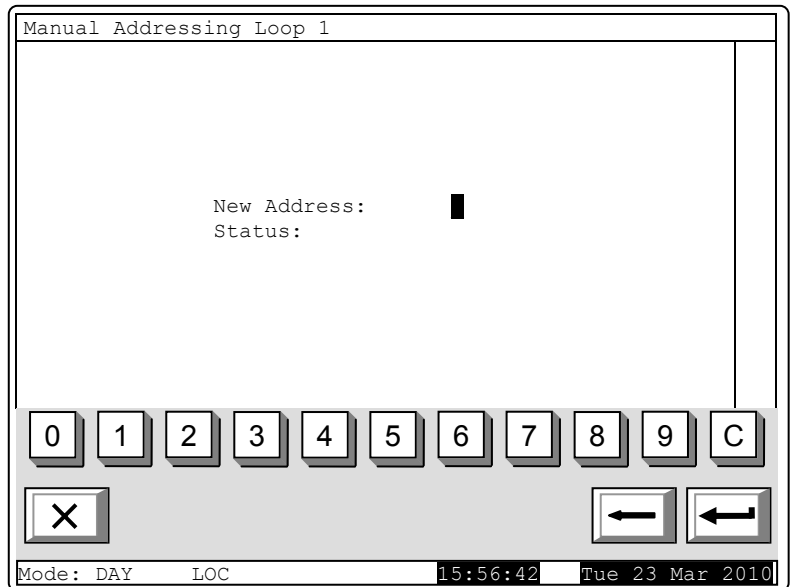

Depending on the device initialization result, one of the following screens will appear:

- \* In case of unsuccessful operation the screen *Fault in device communication* as per section 5.4.a will appear.

- \* In case a device with the same address is detected in the loop:

The device address shall be corrected in the screen using the buttons with figures.

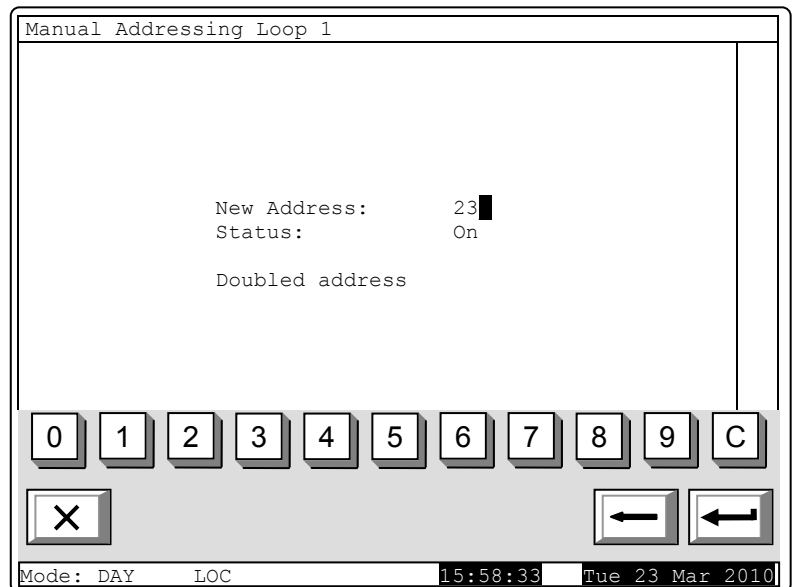

- \* Where no device with the same address is detected and the operation is successful, it will proceed to the next uninitialized device, if any, or the screen from section 5.2. will be displayed.

#### 13.4.5.2 Special features of function *Manual addressing*

1. Function *Manual addressing* can be started when the loop is set to Automated addressing mode. In such case the sequence of automated addressing shall be observed:
  - Devices of the closed loop shall be addressed first, directing from Line 1 (leads Loop 1-1 and Loop 2-1) to Line 2 (leads 1-2 and Loop 2-2);
  - Then devices located in the first branch near Line 1 (if any), directing from the closed loop to the end of the branch;
  - Afterwards devices located in the second branch of Line 1 (if any), directing from the closed loop to the end of the branch, until the last branch, near Line 2 is reached.

If you fail to observe the algorithm, the automated initialization and re-initialization of the devices in the loop will not be performed successfully.

2. Upon exit of the function a check for the number of devices in the loop is performed. In case, during the operation of the function, a device has received an address of higher value, then the number of devices will be increased to reach that same value. During this process can remain addresses, which are On, but are not assigned to any device. When standard initialization is run, for these addresses will be received message for fault condition: Removed device. Example: Before starting the function, 20 devices have been present in the loop, with addresses ranking from 1 to 20; the status of addresses 21-25 is On. During operation of the function one new device received address 25. Upon exit the number of devices is increased from 20 to 25. Upon exit of Set Up Mode a standard initialization of the loop is performed, and for addresses from 21 to 24 a fault condition will be generated – Removed device.



### 13.5. Menu Zones

The menu allows the user to form fire alarm zones and to set up their parameters. Enter the menu to display a screen for zone selection:

For each zone are displayed:

- Its number – in the top line;
- The text message – in the line beneath.

The free zone is displayed first, i.e. the first zone where no devices is integrated in. The selected zone is pointed by arrow „>>“.

Buttons  and  in the right panel section are visualized if at least one zone is available; the Go to field in the heading and the digit buttons appear if more than 6 zones are available.

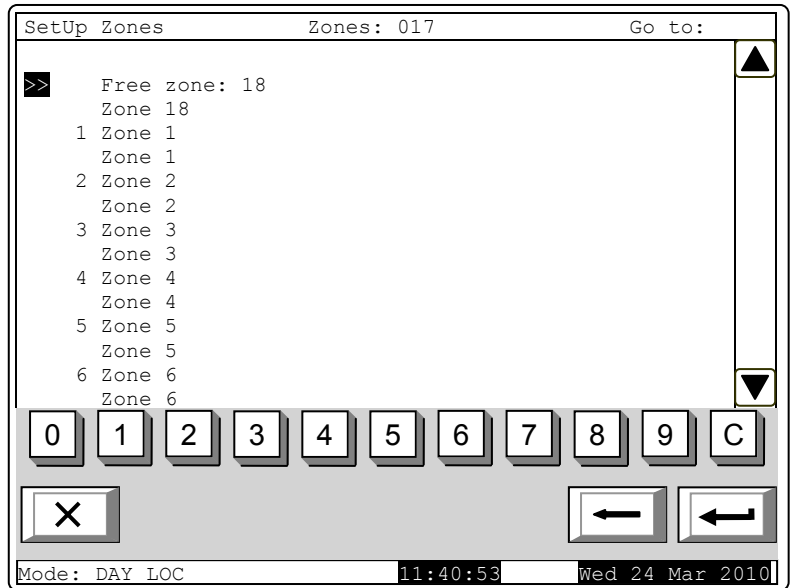

When you press a digit button the Go to field is activated; you can enter a random 3-digit number of a zone. To edit the number use button  - the last inserted digit will be deleted.

When you press button  after you entered a number in the Go to field, the zone whose address is in the field will be selected:

- If the number is 0, Zone 1 will be selected;
- If the number is higher than the actual number of fire alarm zones, the zone having the highest address number will be selected.

Simultaneously the number in the Go to field is deleted, i.e. the field is deactivated.

When you press button  after you entered a number in the Go to field, the field will be deactivated.

When you press button  and the field is empty, a menu containing groups of parameters for the selected zone appears:

- Menu *Devices*;
- Menu *Fire Phase 1 Outputs*;
- Menu *Fire Phase 2 Outputs*;
- Menu *Zone parameters*;
- Menu *Service Remote Zones*;
- Screen Text message.

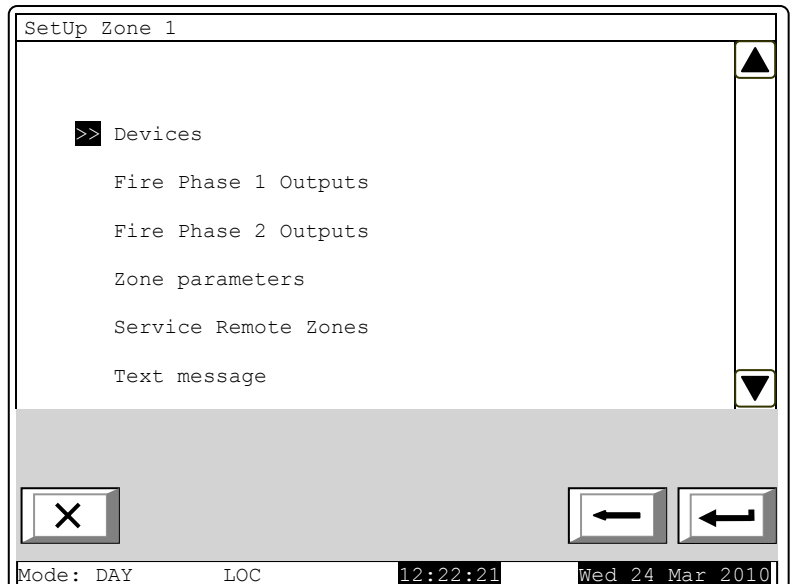

13.5.1. Menu *Devices*

The menu allows the user to integrate (to include) a device in a zone and to exclude a device from a zone. It contains the following submenus and screens:

- Screen *List of devices*;
- Screen *Set zone as free*;
- Menu *Remove address*;
- Menu *Remove address range*;
- Menu *Add address*;
- Menu *Add address range*.

If no devices are present in the zone (free zone) screen *Set zone as free*, menu *Remove address*, and menu *Remove address range* are not accessible. If 60 devices are already added to the zone (the zone is full), the menu *Add address* and menu *Add address range* are not accessible.

13.5.1.1. Screen *List of devices*

The screen displays a list of fire detectors included in the zone. For each devices is displayed the loop where it is included and the device address in the loop:

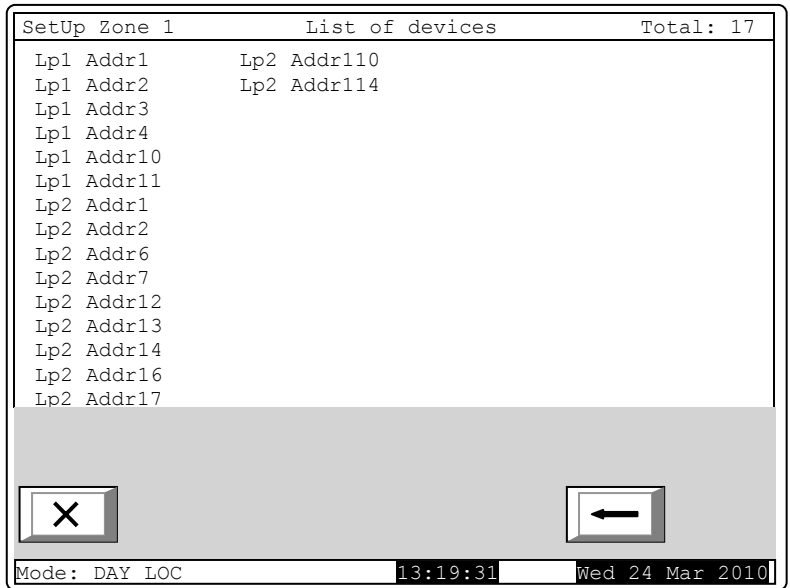

If no fire detectors are integrated in the zone, a screen with the text message *Free zone* appears.

13.5.1.2. Screen *Set zone as free*

The command screen *Set zone as free* allows the user to remove all devices from the zone.

Press button  to remove the devices from the zone and to exit the screen.

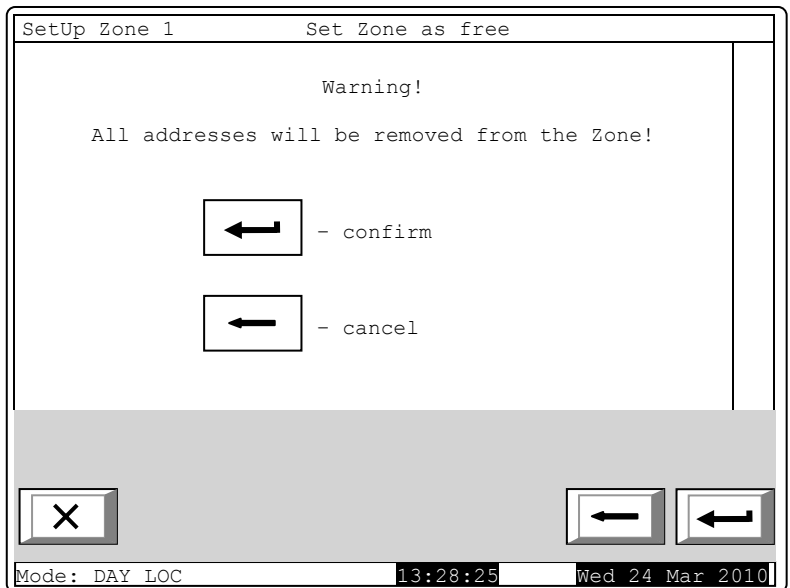

### 13.5.1.3. Menu *Remove address*

The menu allows the user to remove particular devices from the zone:



For each device is displayed:

- Its number in the zone, the loop it is included in, and the address in the loop – in the top line
- The text message – in the line beneath.

The devices in a zone are numbered according to the following sequence:

- Devices in Loop 1 obtain numbers increasing along with the addresses;
- Devices in Loop 2 obtain numbers increasing along with the addresses.

The selected device is pointed by arrow – „>>”.

Buttons  and  in the right panel section are visualized if more than one device is available; the *Go to* field and the digit buttons appear if more than 7 devices are available in the zone.

Press a digit button and the *Go to* field is activated; you can enter a random 2-digit number for a device in the zone. To edit the number, use button , press the button to delete the last inserted digit.

When you press button  and a number is already entered in the *Go to* field, the devices whose number is in the field will be selected:

- If the number is 0, the first device in the zone will be selected;
- If the number is higher than the actual number of devices in the zone, the last device will be selected.

Simultaneously, the number in the *Go to* field will be deleted, i.e. the field is deactivated.

When you press button  after a number is entered in the *Go to* field, the field itself is deactivated.

When you press button  and the *Go to* field is empty, the devices will be removed from the zone. When the last device is removed from the zone a screen with the text message *Free zone* appears; the only option is to exit the menu.

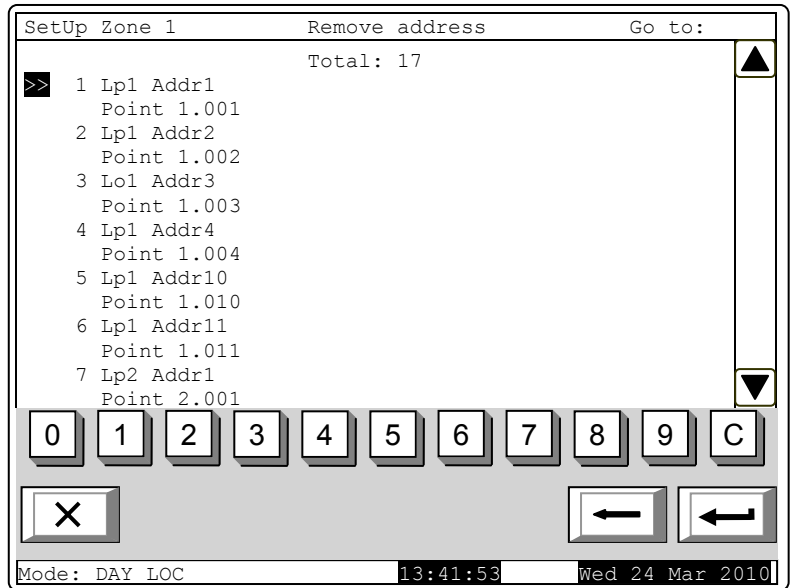





13.5.1.4. Menu *Remove address range*

The menu allows the user to remove a group of devices from the zone, having consequent addresses in a single loop:

For each group of devices the user shall enter:

- The loop where the group is included in – if no value is entered, by default will be accepted Loop 1;
- The address of the first device in the group – if no value is entered by default will be accepted Address 1;
- The address of the last device in the group – if no value is entered by default will be accepted Address 1.

When you press button  a screen with warning message appears:

Press button  Delete to remove from the zone devices included in the group. The screen displays:

- If some devices are still in the zone – a screen for the selection of a group of devices for removal, and the most recent data are saved;
- If no devices are left in the zone – a screen with the text message *Free zone*; the only option is to exit the menu.

In both cases the number of the removed devices from the zone is displayed in the bottom section of the panel.

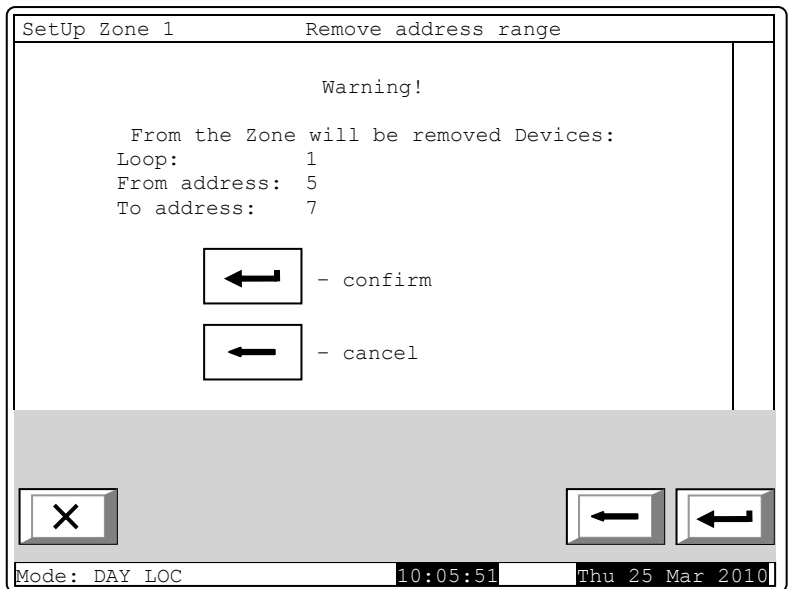
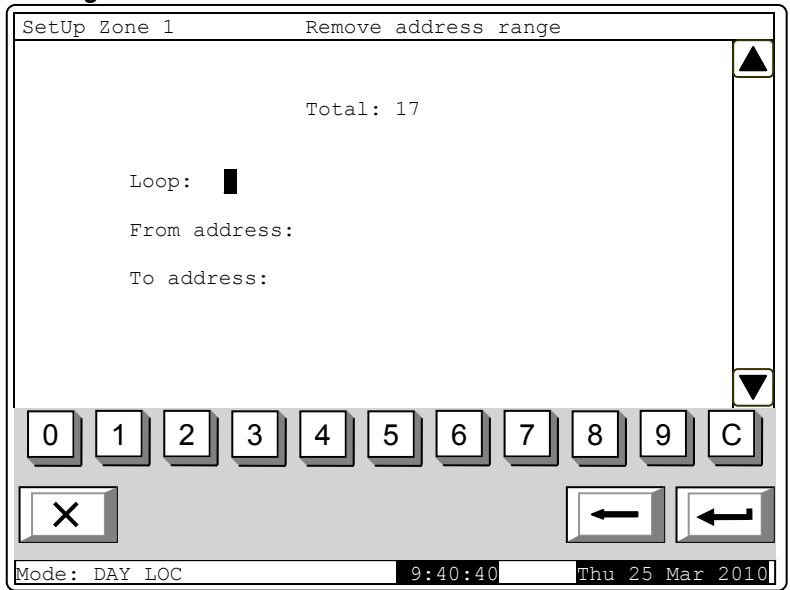

13.5.1.5. Menu *Add address*



The menu allows the user to add separate devices to the zone. Enter the menu to display:

- If no free device is available – a screen with the text message *All addresses are included in zones*, the only option is to exit the menu;
- If a free device is available – a screen displaying the first device that is not included in a zone:

For each device not included in a zone is displayed:

- The loop it is integrated in and the address in the loop – in the top line;
- Text message – in the line beneath.

The selected message is pointed by arrow – „>>”.

Buttons  and  in the right panel section, the *Go to* field in the heading of the panel and the digit buttons are visualized if more than one free device is available.



When you press a digit button, the *Go to* field is activated; you can enter a random 3-digit number for a device in the field. To edit the number push button , and the last inserted digit is deleted.

The devices get numbers in accordance with the following sequence: from the first device in Loop 1 to the last device in Loop 1; from the first device in Loop 2 to the last device in Loop 2.

When you press button  and a number is already entered in the *Go to* field, the first free device whose number is equal to or higher than the number in the field will be selected:

- If the number is 0, the first free device will be selected;
- If the number is higher than the number of the last available free device, then the last device will be selected.

Simultaneously, the number in the *Go to* field is deleted, i.e. the field is deactivated.

When you press button  and a number is already entered in the *Go to* field, then the field will be deactivated.

When you press button  and the field is empty, then the device will be added to the zone. As soon as you add the last available free device, a screen with the text message *All addresses are included in zones*; the only option is to exit the menu. After 60<sup>th</sup> device is added to the zone, a screen with the text message *Full Zone* appears; the only option is to exit the menu.

### 13.5.1.6. Menu *Add address range*

The menu allows the user to add a group of devices, having consequent addresses in a single loop, to the zone:

For each group of devices the user shall enter:

- The loop where the group is included in – if no value is entered, by default will be accepted Loop 1;
- The address of the first device in the group – if no value is entered by default will be accepted Address 1;
- The address of the last device in the group – if no value is entered by default will be accepted Address 1.

Press button  to add the free devices in the group to the zone; the limit of 60 devices in a zone is accordingly observed. The following information is displayed:

- If less than 60 devices are available in the zone – a screen for the selection of a group of devices that are to be added, and the most recent data is saved;
- If 60 devices are already added to the zone – a screen with the message *Full Zone* appears; the only option is to exit the menu.

In both cases the number of the devices added to a zone is displayed in the bottom section of the panel.

13.5.2. Menus *Fire Phase 1 Outputs* and *Fire Phase 2 Outputs*

The menus allow the user to associate outputs to the zone, that will be triggered in fire condition (phase Fire condition stage I and phase Fire condition stage II). The menus contain:

- Menu *Panel Outputs*
- Screen *List of addressable outputs*;
- Menu *Remove addressable output*;
- Menu *Add addressable output*.

If no associated addressable outputs are available, menu *Remove addressable output* is not accessible. If 30 addressable outputs are associated to the zone, menu *Add addressable output* is not accessible.

13.5.2.1. Menu *Panel Outputs*

Menu *Panel Outputs* allows the user to associate control panel outputs to the zone, in accordance with the Fire phase:

To edit the parameters use button  - press it to alternatively change the value of the current parameter to Yes (the output will be activated upon relevant phase of Fire condition in the zone) and to No (the output will remain inactive upon relevant phase of Fire condition in the zone) and vice versa.

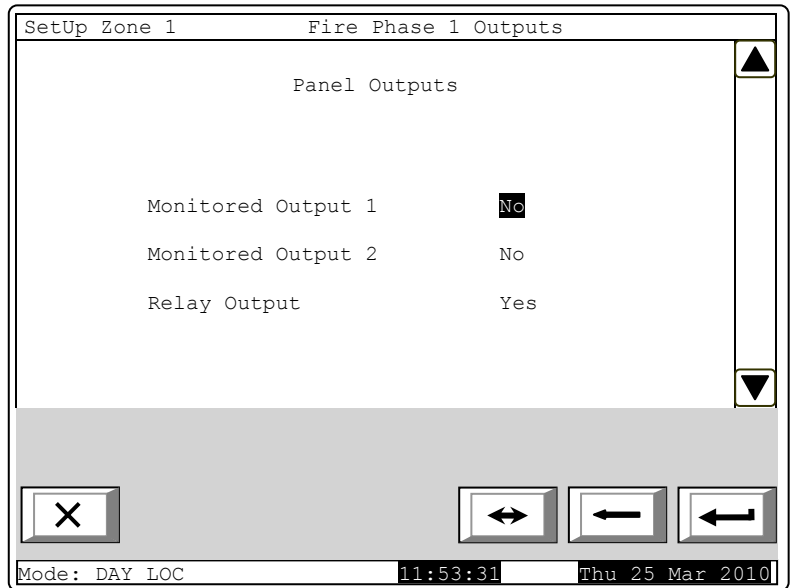

13.5.2.2. Screen *List of addressable outputs*

The screen displays a list of addressable outputs, associated to the zone. For each output is displayed the loop where the output module is included in, its address in the loop and the number of the output in the module, if more than one.

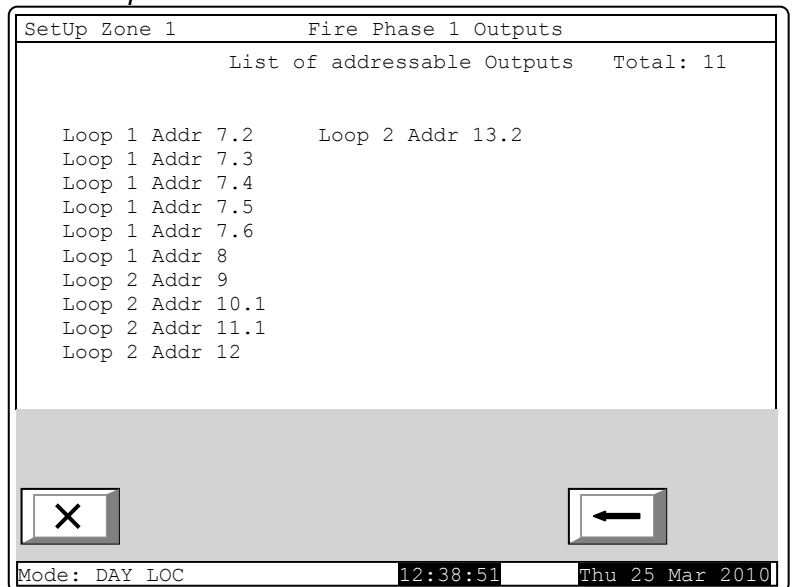

If no addressable outputs are associated to the zone, a screen with the message *No addressable outputs activated upon Fire Condition Phase X* (X stands for phase number – 1 or 2)

13.5.2.3. Menu *Remove addressable outputs*



The menu allows the user to remove separate addressable outputs associated to the zone:

For each output is displayed:

- Its number in the zone; the loop where the device is included; the addresss of the device in the loop and the number of the output in the device, if more than one- in the top line;
- Text message for the devices - in the line beneath.

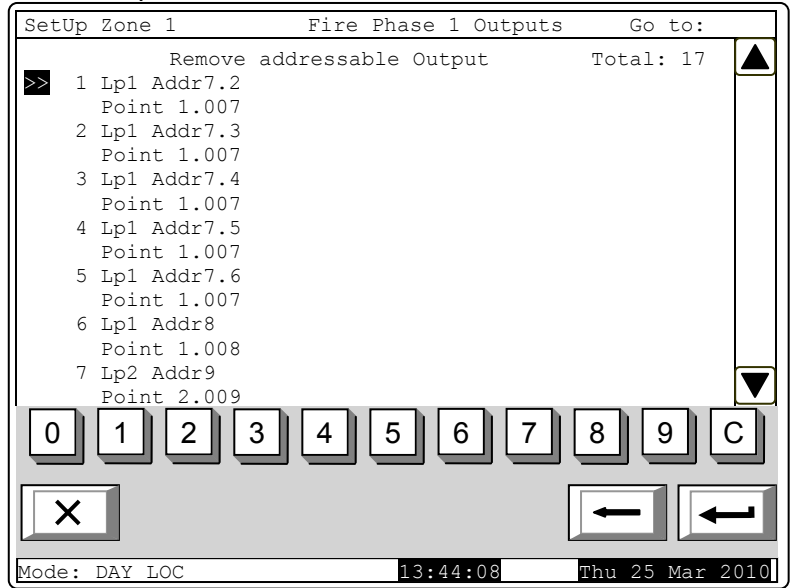
The selected output is poitned by arrow - ">>".



Buttons  and  in the right panel section are visualized where more than one output is available, and the *Go to* field in the heading and the digit buttons appear if more than 7 outputs associated to the zone are available.

When you press a digit button, the *Go to* field is activated; you can enter a random 2-digit number for the output in the zone. To edit the number, use button ; press it to delete the last entered digit.

When you press button  and a number is already entered in the *Go to* field the output whose number is in the field will be selected:

- If the number is 0, the first output assosiated to the zone will be selcted;
- If the number is higher than the actual number of associated outputs, the last output will be selected.

Simultaneously, the number in the *Go to* field is deleted, i.e. the field is deactivated.

When you press button  and the number is already entered in the *Go to* field, the field will be deactivated.

When you press button  and the field is empty, the output will be remoced from the zone. When the last output associated to the zone is removed, a screen with the text message *No addressable outputs activated upon Fire Phase X* (X stands for the Phase number - 1 or 2) is displayed; the only option is to exit the menu.

#### 13.5.2.4. Menu *Add addressable output*

The menu allows the user to associate separate addressable outputs to the zone. Enter the menu to display:



- If no free addressable outputs, not associated to a zone in accordance with the relevant fire phase are available – a screen with the message *No unused outputs* appears; the only option is to exit the menu;
- If a free addressable output, not associated to the zone in accordance with the relevant fire phase is available – a screen with the first free addressable output:

For each addressable output is displayed:

- The loop where the output module is included; the loop address and the number of the output in the module, if more than one – in the top line;
- Text message for the device – in the line beneath.

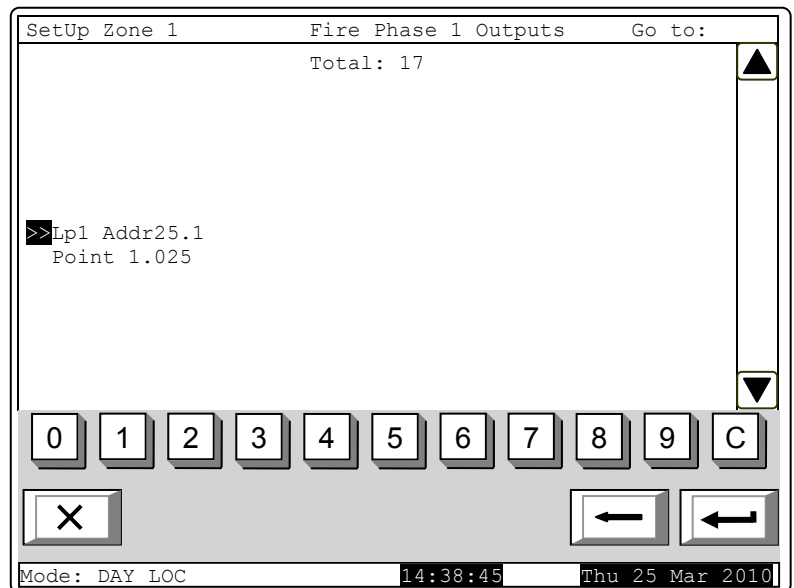
The selected addressable output is pointed by arrow – „>>”.



Buttons  and  in the right panel section are visualized if more that one free addressable output is available, and the *Go to* field in the heading and the digit buttons appear if free addressable outputs in more than one module are available.

When you press a digit button, the *Go to* field is activated; you can enter a random 3-digit number for a device. To edit the number, use button , press it and the last entered digit will be deleted.

The devices obtain numbers according to the following sequence: from the first device in Loop 1 to the last device in Loop 1; from the first device in Loop 2 to the last device in Loop 2.

When you press button  and a number is entered in the *Go to* field, the first free addressable output whose number is equal to or higher than the number in the field will be selected:

- If the number is 0, the first free addressable output will be selected;
- If the number is higher than the number of the device having the last free addressable output, the last free addressable output will be selected.

Simultaneously the number in the *Go to* field is deleted; i.e. the field is deactivated.

When you press button  after you entered a number in the *Go to* field, the field will be deactivated

When you press button  and the *Go to* field is empty, the output will be added to the outputs associated to the zone. When the last free addressable output is added, a screen with the message *No unused outputs* appears; the only option is to exit the menu. When the 30<sup>th</sup> addressable output is associated to the zone, a screen with the message *Additional addressable outputs can not be activated upon Fire Phase X* (X stands for the phase number – 1 or 2); the only option is to exit the menu.

### 13.5.3. Menu *Zone parameters*

The menu is provided for zone parameters set up:

- Manual call point priority – when the manual call points have priority, their response will trigger Fire condition phase 2 in the zone; if they do not have priority, their response will trigger Fire condition phase 1 in the zone; i.e. they will be treated as automatic fire detectors;
- Coincidence mode – when set to this mode, the zone will enter Fire condition phase 1 if at least 2 low priority fire detectors are activated;
- Time Fire Phase 1 – Phase 2 – the delay time before the control panel proceeds from fire condition stage I to fire condition stage II in the zone;
- Inspection time – period of time that, when you press button , will be added to the remaining time for transition from Fire condition stage I to Fire condition stage II in a zone.

To edit parameters *Manual call point priority* and *Coincidence Mode* use button  – by pressing the button you can change the value of the parameter alternatively from *Yes* to *No* and vice versa.

To edit parameters *Time Fire Phase 1 – Phase 2* and *Inspection time* use the digit buttons. When you press button  the digit at the left side of the cursor will be deleted. If the values for *Time Fire Phase 1 – Phase 2* and *Inspection time* are higher than 255, they will be automatically replaced by 255 as soon as the last digit is entered.

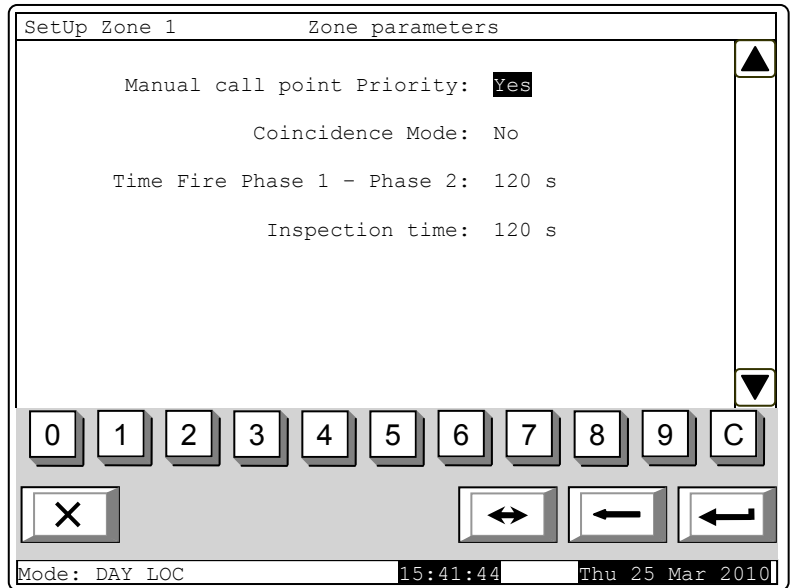

### 13.5.4. Menu *Service Rem. Zones*

The menu allows the user to specify the serviced remote control panels in the zone (see *Interactive Fire Control Panel IFS7002 – Local Network Operation*).

### 13.5.5. Screen *Text message*

The screen allows the user to insert and edit a text message for a zone. Upon activation of the screen a check up is being run for included external keyboard.

#### 13.5.5.1. Built-in keypad



If no external keyboard is included to the control panel, then the following screen appears:



To edit the text use the buttons having symbols – when you press a button, the symbol appears over the position of the cursor, and the previous text is moved one position to the right. The cursor remains for 1 s over the same position; if you press it again, the symbol will be changed by the next one marked on the button (the symbol Ω marked on the second button means that the figure 1 is in combination with punctuation marks). 1 s after the last pressing the cursor moves to the next position to the right. If you press another button



during this 1 second, the cursor first moves one position to the right and then the new symbol is inserted. The maximum length of the message is 40 symbols. If you press a button after a 40-symbol message is already entered, the text will not be accepted and the symbol will not be inserted (the cursor moves one position to the right if the end of the text message is not reached yet).

Press button  to delete:

- The symbol under the cursor, if any;
- The symbol to the left of the cursor, if there is no symbol under it.

Press button  or  to move the cursor one position to the left or to the right.

Button  changes the case from lowercase to uppercase, button  changes the uppercase to lowercase.

Button  changes the Latin font to Cyrillic font, button  changes the Cyrillic font to Latin font.

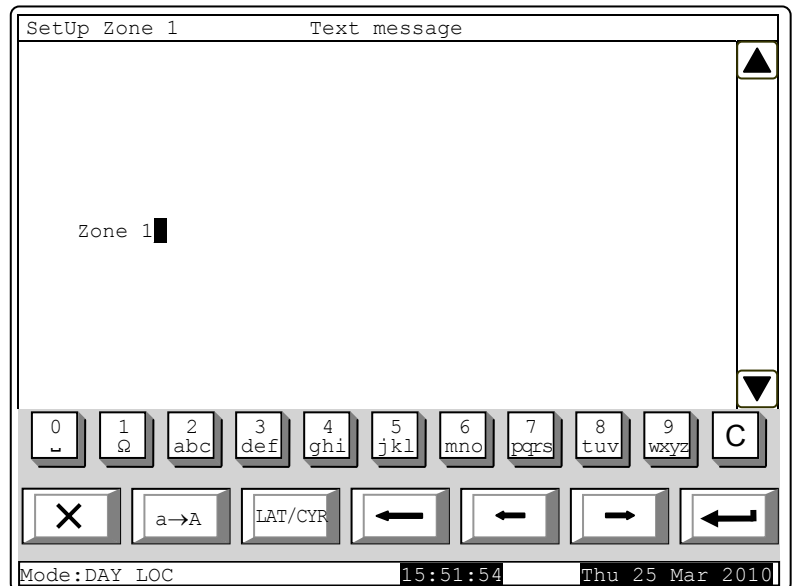



### 13.5.5.2. External keyboard

Where an external keyboard is connected to the control panel, it can be used in SetUp Menu, to enter or correct parameters. When text messages are to be corrected, the following screen appears:

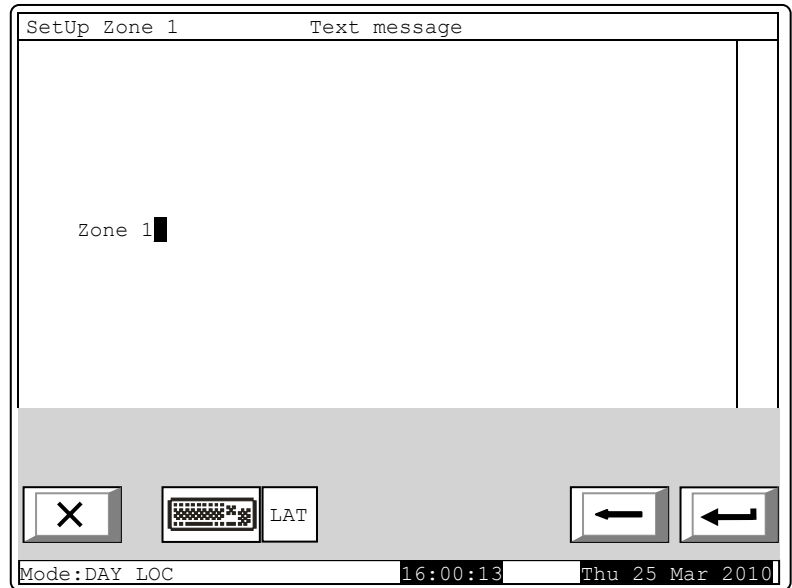

To edit the text use the buttons having symbols – when you press a button, the symbol appears over the position of the cursor, and the previous text and the cursor move one position to the right

The maximum length of the message is 40 symbols. If you press a button after a 40-symbol message is already entered, the text will not be accepted and the symbol will not be inserted.





Press button “Delete” to delete:

- The symbol under the cursor, if any;
- The symbol to the left of the cursor, if there is no symbol under it



Press button  or  to move the cursor one position to the right or to the left.

Use the additional digit keypad to:



- Insert digits – when the LED „Num” is illuminated;
- Move the cursor via buttons „4 / ←” and „6 / →” (analogically to buttons  and ) – when the LED „Num” is extinguished;
- Delete a symbol via button „Del” (analogically to button „Delete”) – when the LED „Num” is extinguished.

The mode of operation of the additional keypad, indicated by the LED „Num” can be changed via button „Num Lock”.

Button „Caps Lock” alternatively changes the case from lowercase to uppercase (LED „Caps” or „A” illuminate to indicate uppercase).

Button „Ctrl” alternatively changes Latin fonts to Cyrillic fonts; the active font is indicated in the bottom section of the display – indicators  and .

To save a text message press button  on the built-in keypad or press button  („Enter”) on the external keypad.

To exit the screen and revert to upper hierarchy menu use button  on the built-in keypad or button  („Back Space”) on the external keypad.

To exit Set Up use button  on the built-in keypad or button „Esc” on the external keypad.

### 13.6. Menu *Inputs*

Use this menu to setup the addressable inputs of FD7203 and to define FD7201 and FD7201S as monitored inputs. FD7203 inputs are reset automatically when the input action ceases. It is possible FD7201 and FD7201S monitored inputs to be setup to be reset automatically when the input action ceases or manually when manually operating the fire control panel. In the menu it is displayed:



- If no addressable input modules are available – a screen with the message *No inputs*; the only option is to exit the menu;
- If addressable input modules are available – a screen for selection of the first addressable input whose parameters are to be set:

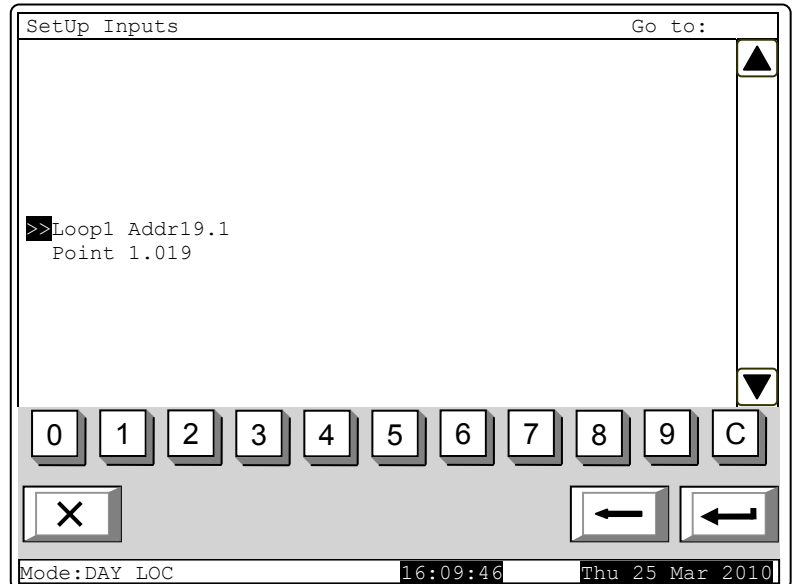

For each addressable input is displayed:

- Loop number, input module address in the loop and the number of the input in the module if more than one – in the top line;
- Text message for the module – in the line beneath.

The selected input is pointed by – „>>”.



Buttons  and  in the right panel section are visualized where more than one addressable input is available, the *Go to* field in the heading and the digit buttons appear if more than one addressable input module is available.

Buttons  and  allow the user to switch between the next and the previous addressable input (if any).

When you press a digit button the arrow „>>” will appear before the selected addressable input is deleted and the *Go to* field is activated; you can enter a random 3-digit number for the device. To edit the number press button  and the last entered digit will be deleted.

Devices obtain numbers according to the following sequence: from first device in Loop 1 to the last device in Loop1; from the first device in Loop 2 to the last device in Loop 2.

When you press button  and a number is entered in the *Go to* field, the first free addressable input of the first addressable input module whose number is equal to or higher than the number in the field will be selected:

- If the number is 0, the first free addressable input will be selected;
- If the number is higher than the number of the last free addressable input module, the last free addressable input will be selected.

Simultaneously the number in the *Go to* field is deleted; i.e. the field is deactivated.

When you press button  after you entered a number in the *Go to* field, the field will be deactivated and the arrow „>>” will appear before the selected addressable output.

When you press button  and the arrow „>>” is visualized (*Go to* field is empty) then a menu containing groups of parameters for the selected addressable output will appear:

- Screen *List of addressable outputs*;
- Menu *Remove addressable output*;
- Menu *Add addressable output*;
- Screen *Outputs activation mode*;
- Menu *Text message*.

13.6.1. Screen *List of addressable outputs*

The screen displays a list of addressable outputs that will be initiated upon activation of the addressable input. For each output is displayed the loop where the output module is included in, its address in the loop and the number of the output in the module, if more than one.

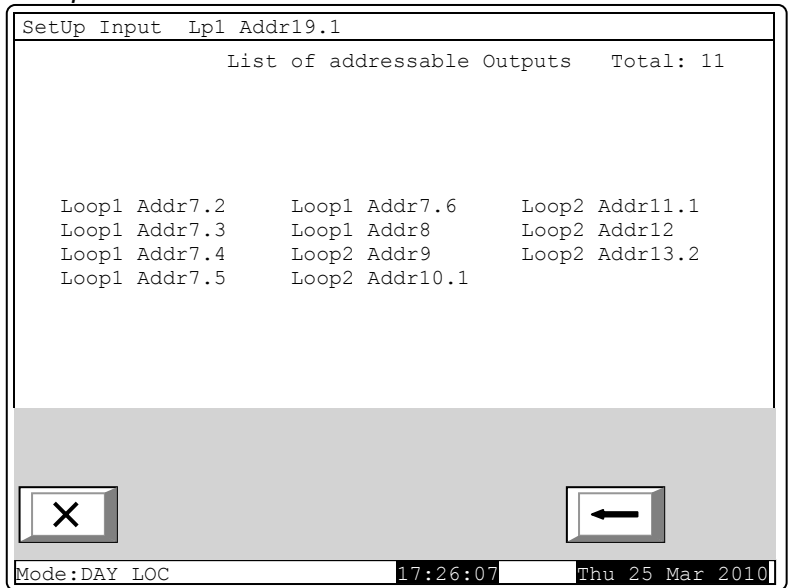

If no addressable outputs subject to activation through the addressable input are available, a screen with the text message *No addressable outputs activated by this Input* appears.

13.6.2. Menu *Remove addressable output*



The menu allows the user to remove separate addressable outputs, activated by the addressable input:

For each addressable output is displayed:

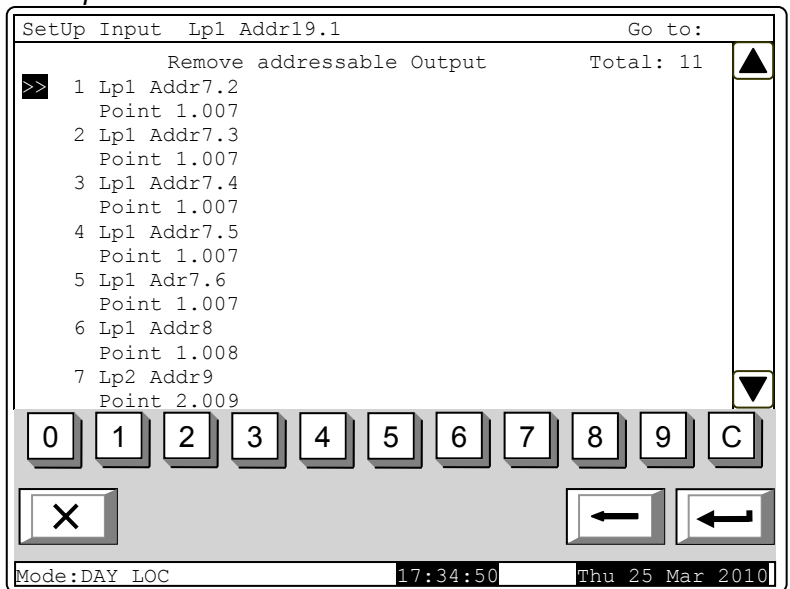
- Its number in the list of outputs, activated by the addressable input; the loop where the module is included; the address of the module in the loop and the number of the output in the module, if more than one – in the top line;
- Text message for the device – in the line beneath.



The selected addressable output is pointed by arrow – „>>”.

Buttons  and  in the right panel section are visualized if more that one addressable output is available, and the *Go to* field in the heading and the digit buttons appear if more than 7 addressable outputs activated by the input are available.

When you press a digit button, the *Go to* field is activated; you can enter a random 2-digit number for the output in the list of outputs activated by the input. To edit the number, use button , press it and the last entered digit will be deleted.

When you press button  and a number is entered in the *Go to* field, the output whose list number is in the field will be selected:

- If the number is 0, the first output activated bythe addressable input will be selected;
- If the number is higher than the number of outputs, activated by the addressable input the last output will be selected.

Simultaneously the number in the *Go to* field is deleted; i.e. the field is deactivated.

When you press button  and the *Go to* field is empty, the list of outputs activated by the addressable input will be deleted. When the last output from the list is deleted, a screen with the message *No addressable outputs activated by this input* appears; the only option is to exit the menu.

13.6.3. Menu *Add addressable output*

The menu allows the user to add separate addressable outputs to the list of outputs subject to activation by the addressable input. Enter the menu to display:



- If no free addressable outputs, not included in the list, are available – a screen with the message *No unused outputs* appears; the only option is to exit the menu;
- If a free addressable output, not included in the list, is available – a screen displaying the first free addressable output:

For each addressable output is displayed:

- The loop where the input module is included in; the module address in the loop and the number of the output in the module, if more than one – in the top line;
- Text message for the module – in the line beneath.

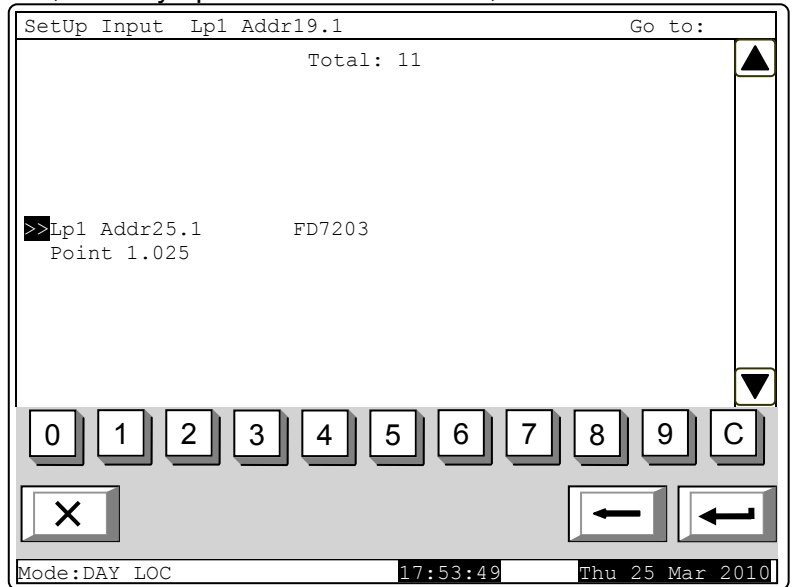
The selected addressable output is pointed by arrow – .



Buttons  and  in the right panel section are visualized if more than one free addressable output is available, the *Go to* field and the digit buttons appear if free addressable outputs in more than one module are available.

When you press a digit button, the *Go to* field is activated and you can enter a random 3-digit number for the module. To edit the number, use button  and the last inserted digit will be deleted.

Devices obtain numbers according to the following sequence: from the first device in Loop 1 to the last device in Loop 1; from the first device in Loop 2 to the last device in Loop 2.

When you press button  and a number is entered in the *Go to* field, the first free addressable output in the first module whose number is equal to or higher than the number in the field will be selected:

- If the number is 0, the first free addressable output will be selected;
- If the number is higher than the number of the module having the last free addressable output, then the last output will be selected.

Simultaneously the number in the *Go to* field is deleted; i.e. the field is deactivated.

When you press button  and a number is entered in the *Go to* field, the field will be deactivated.

When you press button  and the *Go to* field is empty, the output will be added to the list of outputs, activated by the addressable input. When the last free addressable output is added, the message *No unused outputs* appears; the only option is to exit the menu. When 12<sup>th</sup> addressable output is added to the list of outputs activated by the addressable input, the message *Additional addressable outputs can not be activated by this input* appears; the only option is to exit the menu.

13.6.4. Screen *Outputs activation mode*

Use this screen to setup the fire control panel mode for activating the outputs assigned to the input when the input is activated:

- In Duty Mode;
- In Fire Condition;
- In Duty Mode and Fire Condition;

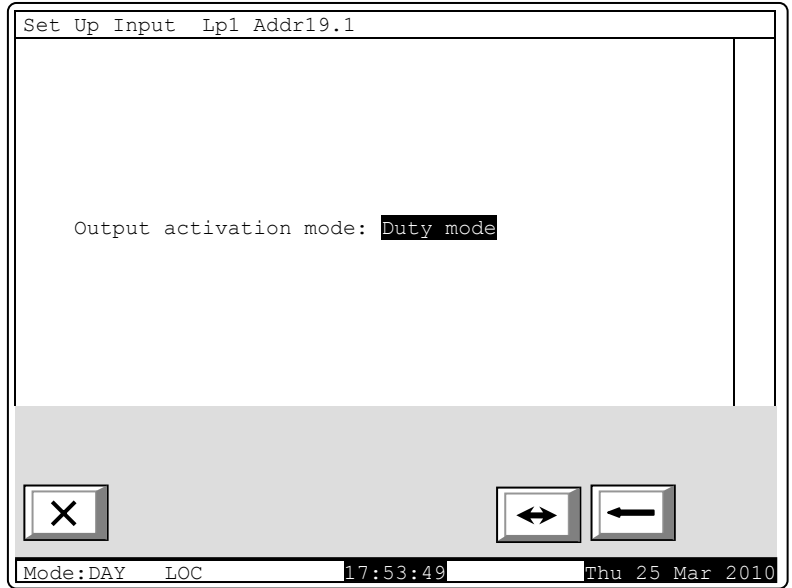

13.6.5. Menu *Text message*

The menu allows the user to set a text message that will be displayed upon activation of the addressable input:

For FD7203 the menu contains:

- Parameter *Text message No* – it accepts values from 0 to 100. Value 0 means, that upon activation of the addressable input no message will be displayed. Values within the range 1-100 indicate the number of the text message that shall be displayed upon activation of the addressable input;
- Subordinate screen *Edit* – the text message can be edited here.

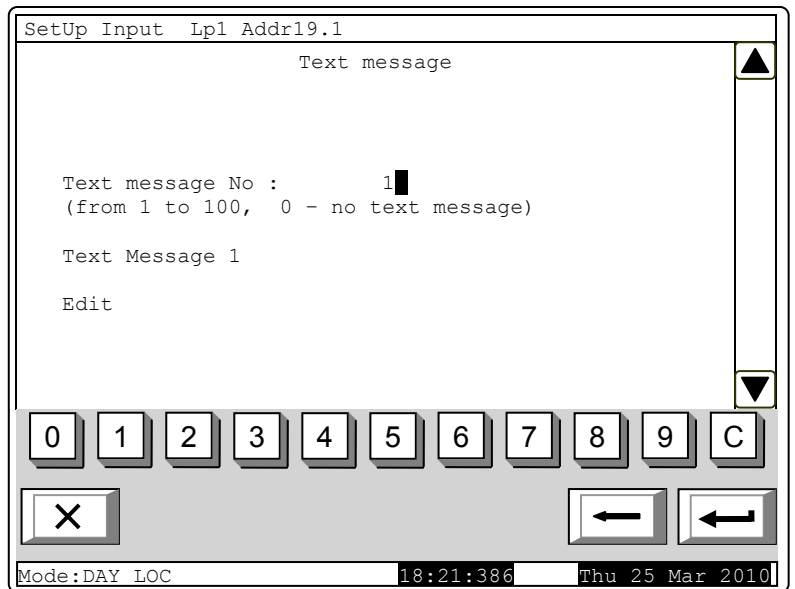

Note: Keep in mind that one and the same text message can be displayed upon activation of a number of addressable inputs.

The content of the text message is displayed too. If no text message is set (the numer is 0) this line remains empty.

To edit the parameter *Text message No* use the digit buttons. The pointer (here visualized as cursor „█”) indicates the position where the digit will appear. Press button **C** to delete the digit before the cursor.

When you move the pointer from *Text message No* to *Edit* the content of the text message on the display is being refreshed if any changes are made in the parameter *Text message No*.

When you press button **←** the following operation will be run:

- If any changes in the parameter *Text message No* are made – the number of the text message will be saved;
- If any changes in the parameter *Text message No* are made and the pointer is at the parameter – the content of the text message on the display will be refreshed;

- If the pointer is at parameter *Edit* and the value of *Text message №* is higher than 0 – screen *Edit* will be activated.

Screen *Edit* allows the user to set and edit a text message for the addressable input. Upon activation of the screen a check for included external keyboard is being run.

The screen Text Message Edit is displayed for FD7201 and FD7201S configured as inputs.

#### 13.6.5.1. Built-in keypad

If no external keyboard is available, the following screen appears:

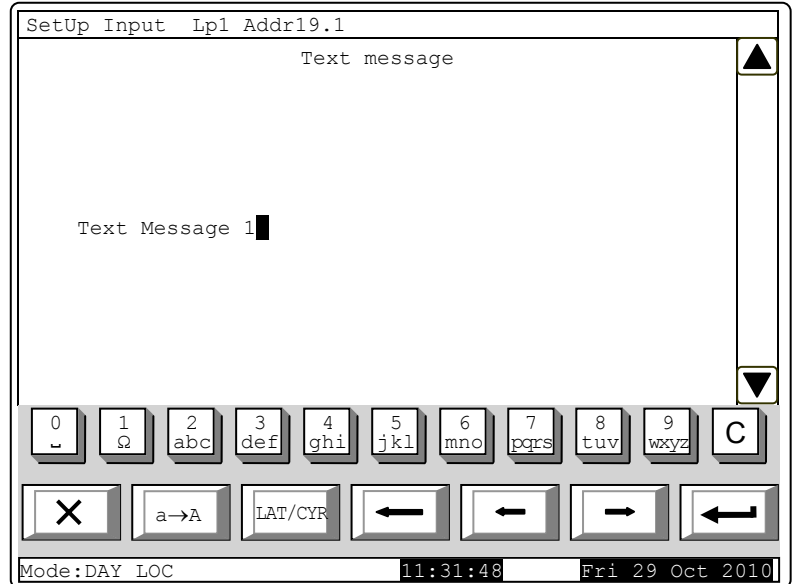





To edit the text use the buttons having symbols – when you press a button, the symbol appears over the position of the cursor, and the previous text and the cursor move one position to the right. The cursor remains for 1 s over the same position; if you press it again, the symbol will be changed by the next one marked on the button (the symbol  $\Omega$  marked on the second button means that the figure 1 is in combination with punctuation marks). 1 s after the last pressing the cursor

moves to the next position to the right. If you press another button during this 1 second, the cursor first moves one position to the right and then the new symbol is inserted. The maximum length of the message is 40 symbols. If you press a button after a 40-symbol message is already entered, the text will not be accepted and the symbol will not be inserted (the cursor moves one position to the right if the end of the text message is not reached yet).

Press button  to delete:

- The symbol under the cursor, if any;
- The symbol to the left of the cursor, if there is no symbol under it

Press button  or  to move the cursor one position to the right or to the left.

Button  changes the case from lowercase to uppercase, button  changes the case from uppercase to lowercase.

Button  changes Latin fonts to Cyrillic fonts; button  changes Cyrillic fonts to Latin.

### 13.6.5.2. External keyboard

If an external keyboard is included to the fire control panel, the following screen appears:

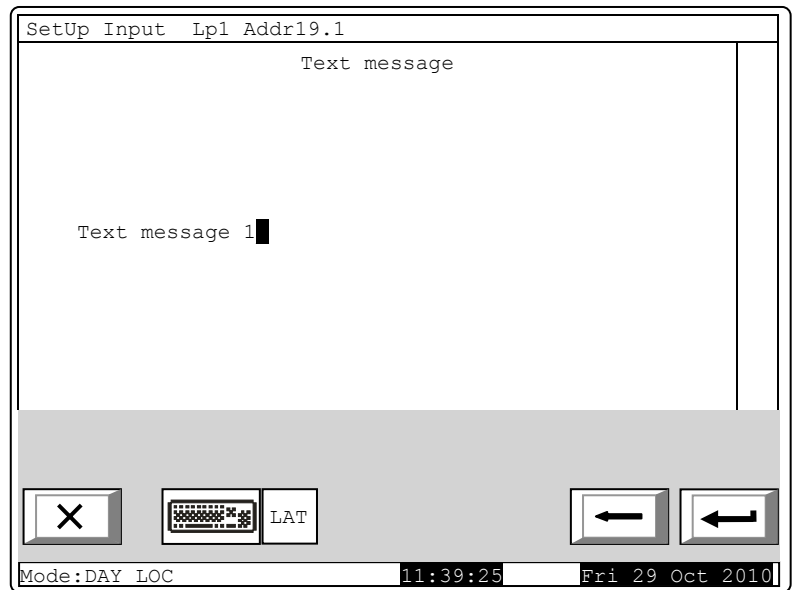

To edit the text use the buttons having symbols – when you press a button, the symbol appears over the position of the cursor, and the previous text and the cursor move one position to the right.

The maximum length of the message is 40 symbols. If you press a button after a 40-symbol message is already entered, the text will not be accepted and the symbol will not be inserted.





Press button “Delete” to delete:

- The symbol under the cursor, if any;
- The symbol to the left of the cursor, if there is no symbol under it.



Press button  or  to move the cursor one position to the right or to the left.



Use the additional digit keypad to:



- Insert digits – when the LED „Num” is illuminated;
- Move the cursor via buttons „4 / ←” and „6 / →” (analogically to buttons  and ) – when the LED „Num” is extinguished;
- Delete a symbol via button „Del” (analogically to button „Delete”) – when the LED „Num” is extinguished.

The mode of operation of the additional keypad, indicated by the LED „Num” can be changed via button „Num Lock”.

Button „Caps Lock” alternatively changes the case from lowercase to uppercase (LED „Caps” or „A” illuminate to indicate uppercase).

Button „Ctrl” alternatively changes Latin fonts to Cyrillic fonts; the active font is indicated in the bottom section of the display – indicators  and .

To save a text message press button  on the built-in keypad or press button  („Enter”) on the external keypad.

To exit the screen and revert to upper hierarchy menu use button  on the built-in keypad or button  („Back Space”) on the external keypad.

To exit Set Up use button  on the built-in keypad or button „Esc” on the external keypad.

### 13.7. Menu Initialization

The menu is used for the settings relevant to initialization of the addressable devices in the fire alarm loops. It contains the following submenus and functions:

- Function *Initialization*;
- Function *Clean initialization*;
- Menu *Readdressing*;
- Menu *Exclude devices*;
- Menu *Check*.

### 13.7.1. Function *Initialization*

The function performs standard initialization of the addressable devices in the fire alarm loops.

Upon activation of the function the following warning screen appears:

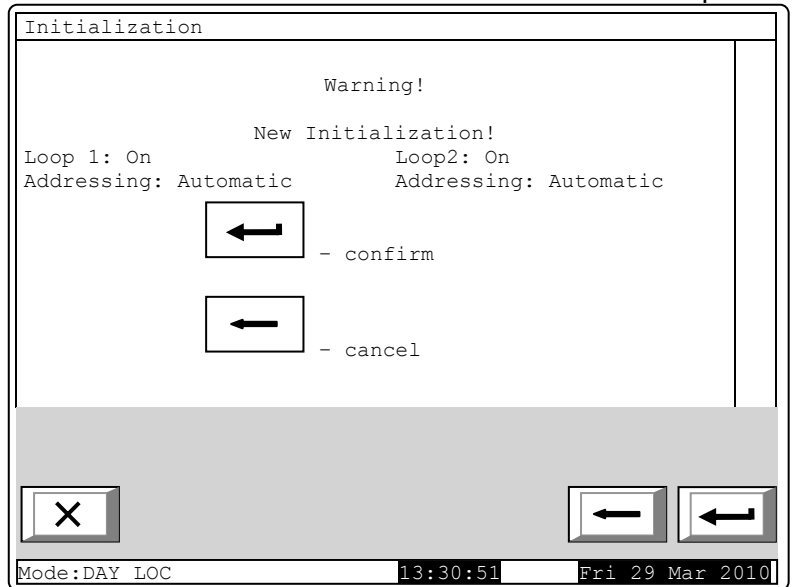

Start the initialization via button  and in the bottom line of the panel appears the message *Wait please...*

Upon unsuccessful initialization appears the following screen:

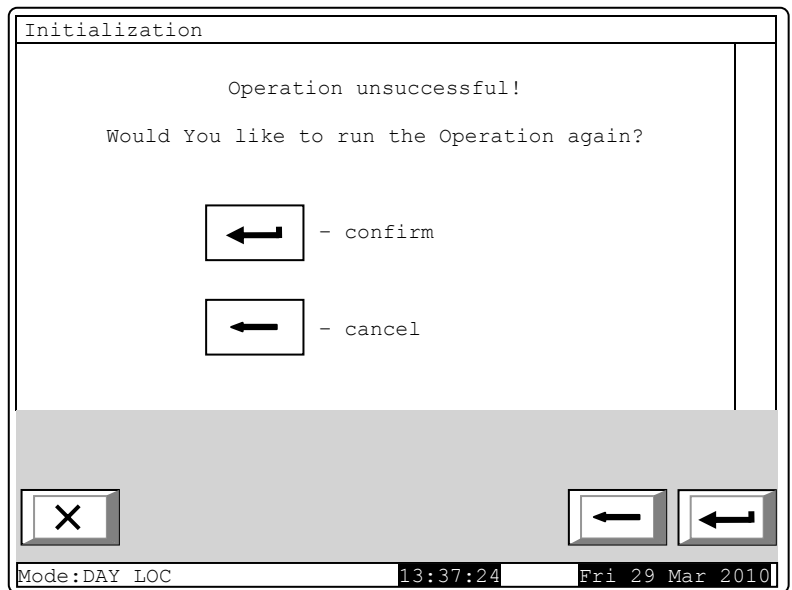



In case of successful initialization the following screen is displayed:

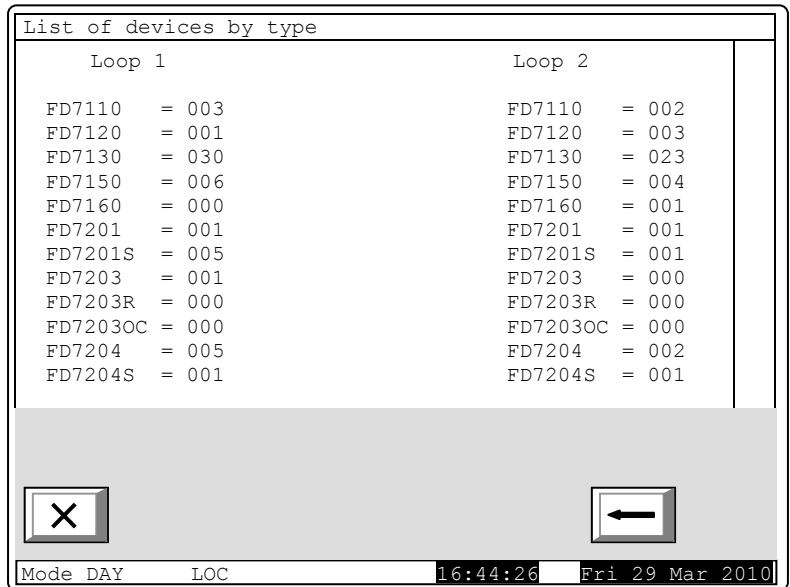

Notes:

1. Only swithed on loops can be initialized.
2. The function is not affected by removed addressable devices, i.e. the opretaion will be successful even when some devices are removed from the loops (but no more than 19 devices).

13.7.2. Function *Clean initialization*

The function performs clean initialization of addressable devices in fire alarm loops which ahs been set to automated addressing mode.

Upon activation of the function the following warning screen appears:

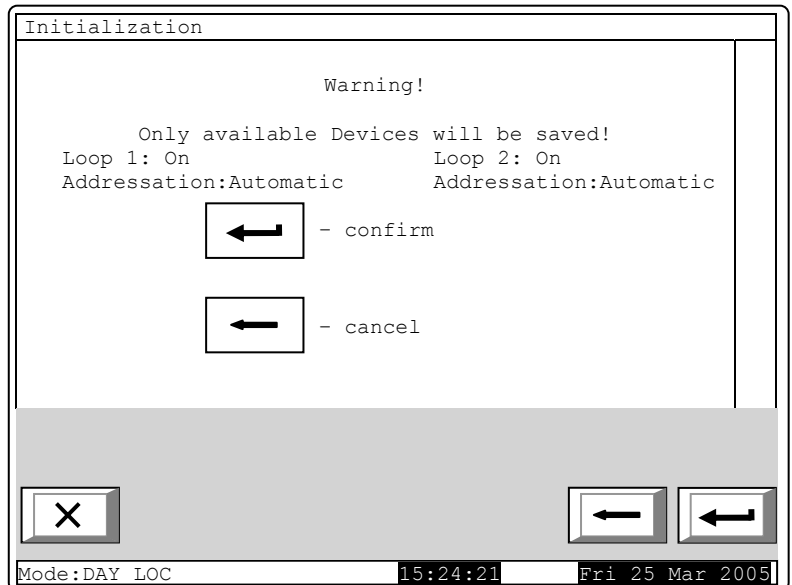

Start the initialization via button  and in the bottom line of the panel appears the message *Wait please...*

Upon unsuccessful initialization appears the following screen:

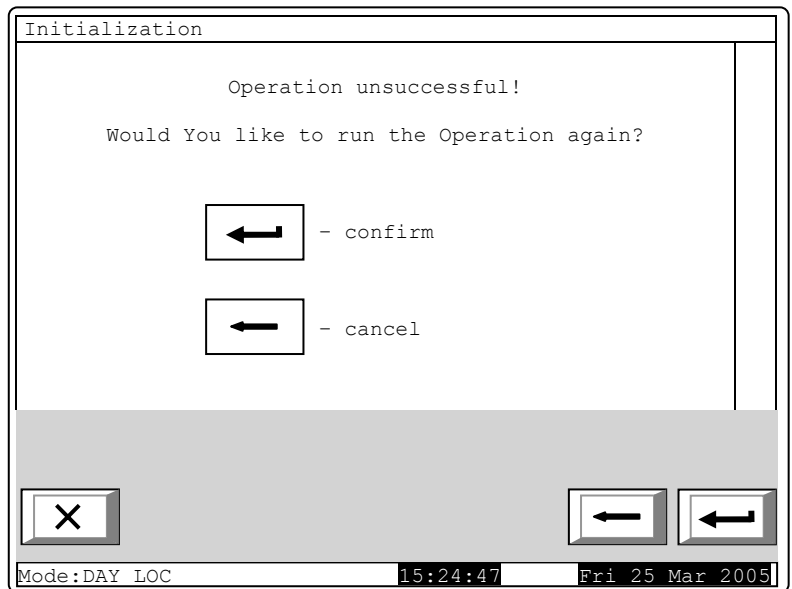

In case of successful initialization the following screen is displayed:

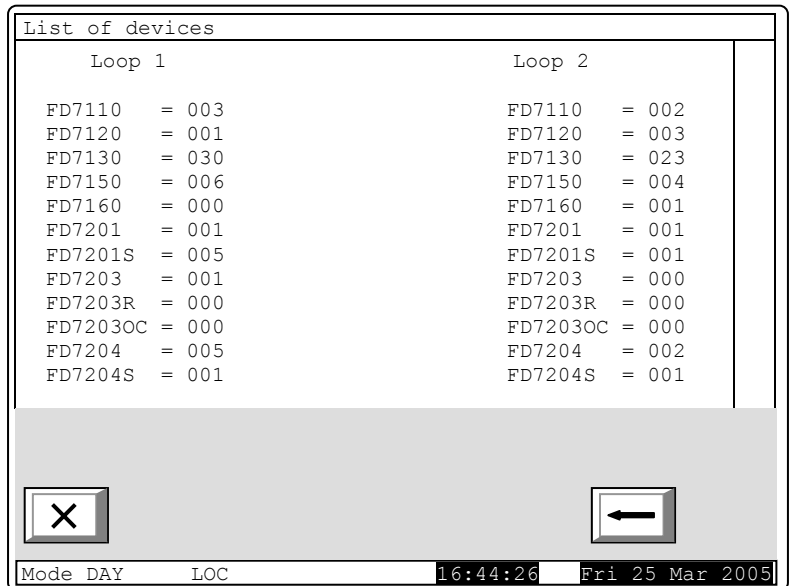

Notes: Only switched on loops can be initialized, which are in automatic addressation mode. Where a loop is set to manual addressing mode, then the clean initialization is always unsuccessful. To make it successful, switch off the loop in manual addressing mode or to change in automatic initialization.

13.7.3. Menu *Readdressing*

The menu allows the user to exclude an addressable device from the service zone. Enter the menu to display:

- If no devices are available in the service zone – a screen with the message *The service Zone is empty*; the only option is to exit the menu.
- If some devices are included in the service zone – a screen for the selection of device that shall be excluded from the service zone:

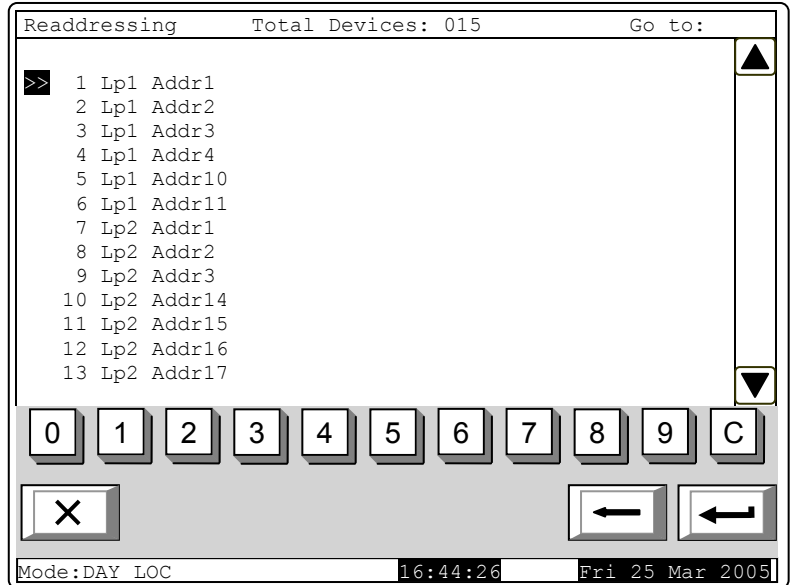

For each device is displayed the loop it is included in and its address in the loop.

The current device is pointed by arrow – "➤".

The field *Go to* in the heading and the digit buttons are visualized if more than 13 devices are available in the service zone.

When you press a digit button, the *Go to* field is activated and you

can enter a random 3-digit number for a device in the service zone. To edit the number use button **C**, which will delete the last digit you entered.

When you press button **←** and a number is already entered in the *Go to* field, the device whose number in the service zone is in the field will be selected:

- If the number is 0, the first device in the service zone will be selected;
- If the number is higher than the actual number of devices in the service zone, then the device having the highest number in the service zone will be selected.

Simultaneously, the number in the *Go to* field is deleted, i.e the field is deactivated.

When you press button **←** and a number is entered in the *Go to* field, the field will be deactivated.

When you press button **←** and the *Go to* field is empty, a screen for selection of new address for the device appears:



As supplementary information is visualized the address range where the new address of the device can be selected from.

To enter the new address use the digit buttons. Press button **C** to delete the digit to the left of the cursor.

If the new address is out of the specified range, button  is ignored. Otherwise a command screen appears where you shall confirm the readdressing:

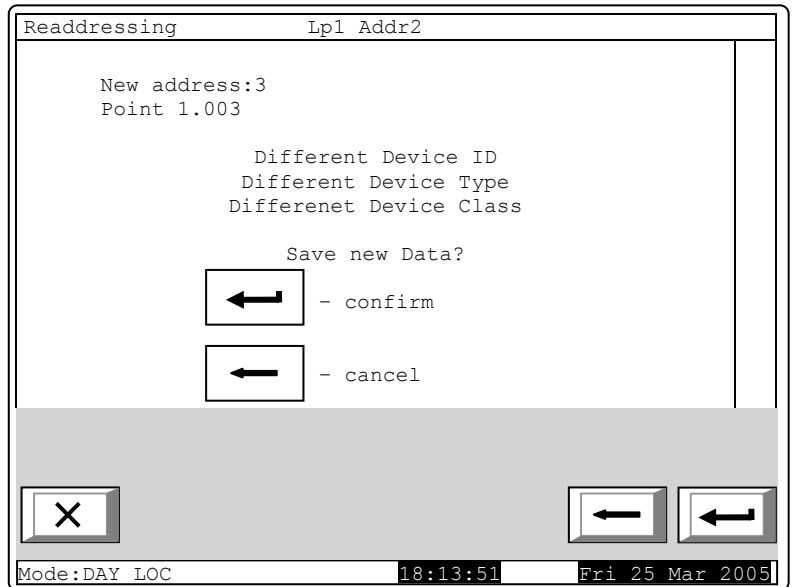

The following information is displayed on the screen:

- The new address that will be assigned to the device;
- The text message specified for this address;
- Message *Different device ID* – only when the ID number of the device is different than the number for this address saved in the control panel;
- Message *Different device type* – only when the device type is different than the type saved for this address in the control panel;
- Message *Different device class* – only when the temperature class of the device is different than the class saved in the control panel.

When you press button  the readdressing is cancelled and the screen for selection of new address is reverted.

When you press button  the readdressing is completed and the screen for selection of devices that shall be excluded from the service zone is reverted (or the screen with the message *The service zone is empty*).

#### 13.7.4. Menu *Exclude devices*

The menu allows the user to exclude or include separate addressable devices:

All 250 (125 in each loop) addressable devices are accessible whether included physically to the fire alarm loops or not. In the middle of the heading is displayed the total number of devices included in both loops.

For each device is displayed:

- Its consecutive number, the loop it is included in and its address in the loop – in the top line;
- The text message – in the line beneath.

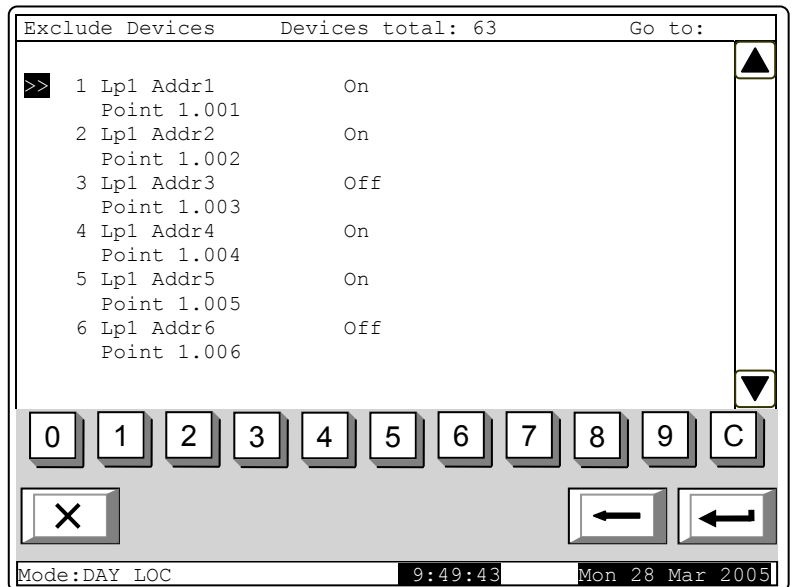

The devices obtain numbers according to the sequence:

- Devices in Loop 1 – numbers from 1 to 125;
- Devices in Loop 2 – numbers from 126 to 250.

The selected device is pointed by arrow – .

When you press a digit button, the *Go to* field is activated and you can enter a random 3-digit number for the device. To edit the number, press button  and the last entered digit will be deleted.

When you press button  and a number is already entered in the *Go to* field, the device whose number is in the field will be selected:

- If the number is 0, Address 1 in Loop 1 will be selected ;
- If the number is higher than 250, Address 125 in Loop 2 will be selected.

Simultaneously, the number in the *Go to* field is deleted, i.e. the field is deactivated.

When you press button  and a number is entered in the *Go to* field, the field will be deactivated.

When you press button  and the *Go to* field is empty, a screen for exclusion/inclusion of the addressable device appears:

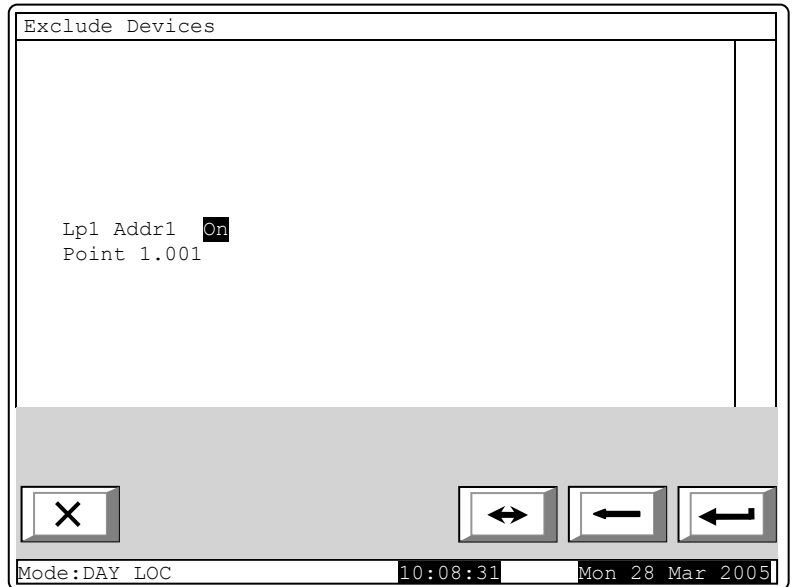

The status of the device is displayed in inversive colours. Change the status by pressing button

 – the status is changed alternatively from *included* to *excluded* and vice versa.

### 13.7.5. Menu Check

The menu is provided for check up of the initialization of addressable devices, included in the fire alarm loops.

When you enter the menu the following operations are being run:

- If no devices are available in the loops – a screen with the message *No devices* appears; the only option is to exit the menu;
- If some devices are available in the loops – a command for LEDs illumination is sent to the first device, if the loops are *On* and are initialized. A screen for the device status and for selection of the next device for check up is visualized:

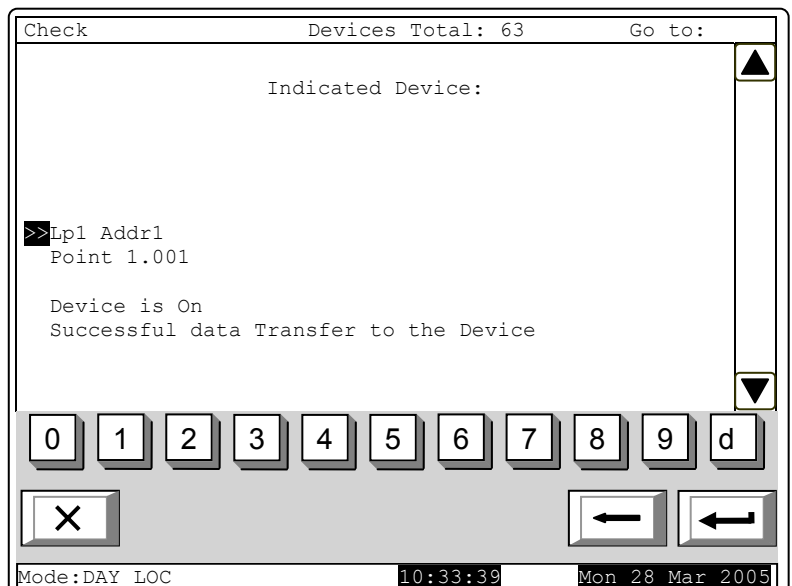

For the current device is displayed:

- The loop it is included in, and its address in the loop;
- Its text message;
- Device status (On or Off) – it is displayed only when the loop the device is included in is On and is initialized;

- Information for the communication with the devices:
  - ◆ the loop is off – appears the message *The loop is off* (no attempt for communication with the device has been made);
  - ◆ the loop is On, but is not initialized – appears the message *Uninitialized loop* (no attempt for communication with the device has been made);
  - ◆ the loop is On and is initialized – as a result from communication with the device (*Successful data transfer to the device* or *Error in data transfer to the device*).

The current device is pointed by arrow – „>>“.

When the data transfer is successful the device LEDs illuminate and indicate the physical device having this particular address.

When you press a digit button the *Go to* field is activated; you can enter a random 3-digit number for the device. To edit the number use button  press it to delete the last entered digit.

The devices obtain numbers according to the following sequence: from the first device in Loop 1 to the last device in Loop 1; from the first device in Loop 2 to the last device in Loop 2.

When you press button  and a number is already entered in the *Go to* field, the device whose address is in the field will be selected:

- if the number is 0, the first addressable device in the control panel will be selected;
- if the number is higher than the actual number of devices in the loop, the last device in the control panel will be selected.

At the same time:

- the number in the *Go to* field is deleted, i.e. the field is deactivated;
- the device that has been checked receives a command to extinguish the LEDs, if the device loop is On and is initialized;
- the device that has been selected for check-up, receives a command to illuminate the LEDs, if the loop is On and is initialized;
- the screen is refreshing the status of the new device.

When you press button  and a number is already entered in the *Go to* field, the field is deactivated.

When you press button  and the *Go to* field is empty, the button effect is ignored.

Upon exit of the menu the last checked device receives command to extinguish its LEDs, if the loop is On and is initialized.

**13.8. Menu Checks**

The menu allows the user to set up the control panel outputs (monitored, relay and addressable), the display and the buttons. It contains the following submenus and functions:

- Menu *Monitored outputs*;
- Menu *relay outputs*;
- Menu *Addressable outputs*;
- Function *Display*;
- Menu *Buttons*.



**13.8.1. Menu Monitored outputs**

Using the menu you can run a check on control panel monitored outputs.

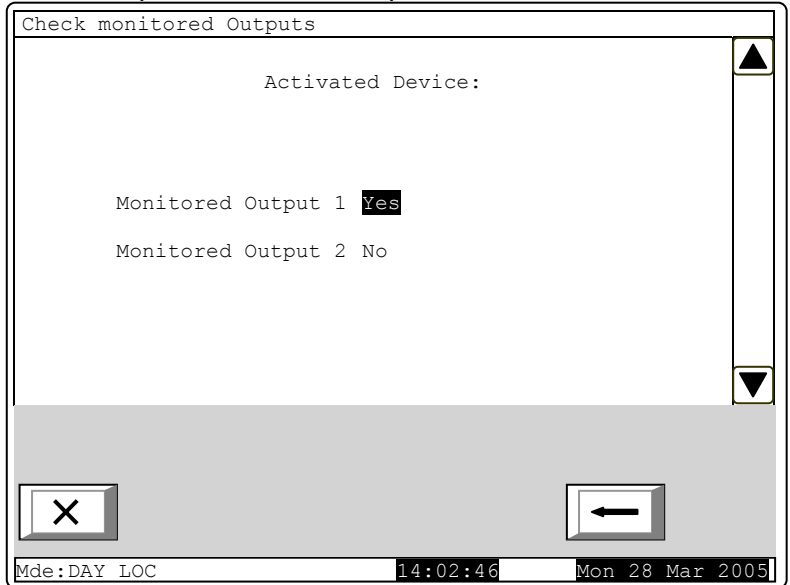
When you enter the meny Monitored output 1 is triggered (if not in Fault condition) and the following screen appears:



At the activated monitored output is displayed the message *Yes*, in inversive colours; at the output not activated yet is displayed the message *No* in general colours.

When you press button  or  the activated monitored output is switched off and the other output is activated (if not in fault condition).

Upon exit of the menu the activated monitored output is switched off.



**13.8.2. Menu Relay outputs**

Using the menu you can run a check on the relay outputs of the fire control panel.

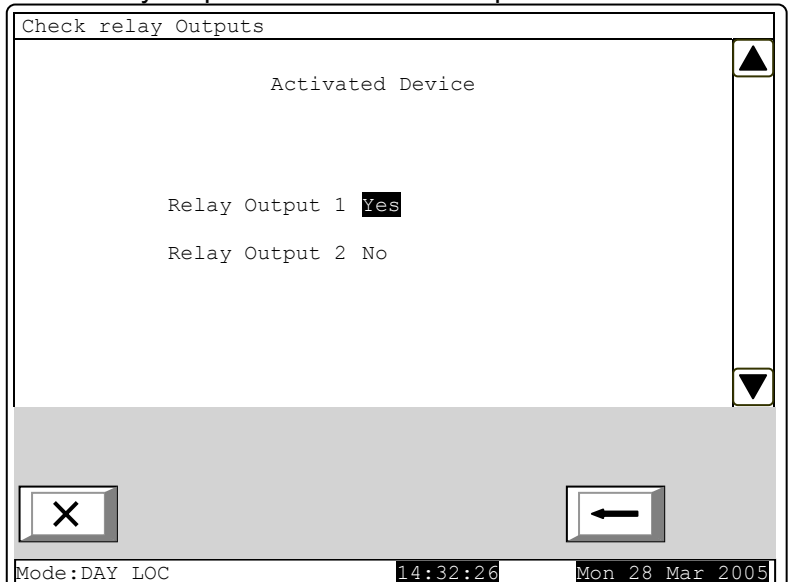
When you enter the menu, Relay output 1 is activated and the following screen appears:



At the activated relay output appears the message *Yes* in inversive colours; at the realy output not activated yet appears the message *No*, in general colours.

When you press button  or  the activated relay outputs is switched off, and the other one is activated.

Upon exit of the menu the activated relay output is switched off.

### 13.8.3. Menu *Addressable outputs*

Use the menu to check the addressable outputs of the control panel.

When you enter the menu the following operations are being run:

- If no addressable outputs are available – a screen with the message *No addressable outputs* appears; the only option is to exit the menu;
- If some addressable outputs are available – a command for activation is sent to the first addressable output, if the loop is On and is initialized. A screen for the output status and for selection of the next output for check up is visualized:

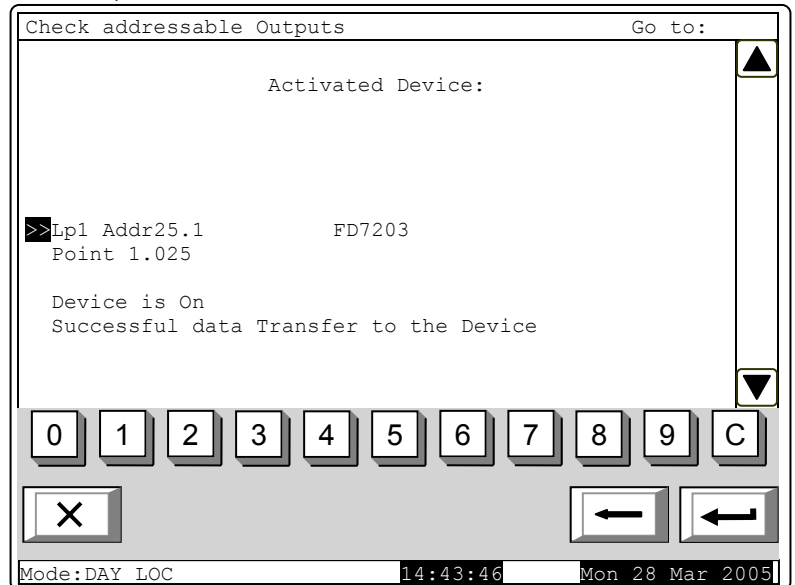



For the current addressable output is displayed:

- The loop it is included in, its address in the loop and the number of the output in the device, if more than one output is available;
- Device text message;
- Device status (*On* or *Off*) – it is displayed only when the loop the device is included in is *On* and is initialized;
- Information for the communication with the device:
  - ◆ the loop is off – appears the message *The loop is off* (no attempt for communication with the device has been made);
  - ◆ the loop is On, but is not initialized – appears the message *Uninitialized loop* (no attempt for communication with the device has been made);
  - ◆ the loop is On and is initialized – as a result from communication with the device (*Successful data transfer to the device* or *Error in data transfer to the device*).

The current addressable output is pointed by arrow – „>>“.

When the data transfer is successful the device output will be activated.

Buttons  and  in the right panel section are visualized if more than one addressable output is available; the *Go to* field in the heading and the digit buttons appear if addressable outputs in more than one device are available.

When you press a digit button the *Go to* field is activated; you can enter a random 3-digit number for the device. To edit the number use button  press it to delete the last entered digit.

The devices obtain numbers according to the following sequence: from the first device in Loop 1 to the last device in Loop 1; from the first device in Loop 2 to the last device in Loop 2.

When you press button  and a number is already entered in the *Go to* field, the first addressable output in the first device whose number is equal to or higher than the number in the field will be selected:

- if the number is 0, the first addressable output will be selected;
- if the number is higher than the number of device having the last addressable output, the last addressable output will be selected.

At the same time:

- the number in the *Go to* field is deleted, i.e. the field is deactivated;
- the output that has been checked receives a command to switch off, if the loop is On and is initialized;
- the output that has been selected for check-up, receives a command for activation, if the loop is On and is initialized;
- the screen is refreshing the status of the new output.



When you press button  and a number is already entered in the Go to field, the field is deactivated.

When you press button  and the Go to field is empty, the button effect is ignored. Upon exit of the menu the last checked output receives command for deactivation, if the loop is On and is initialized.

13.8.4. Function *Display*

Use the function to check the LCD display of the fire control panel.

When you enter the function the following screen appears:

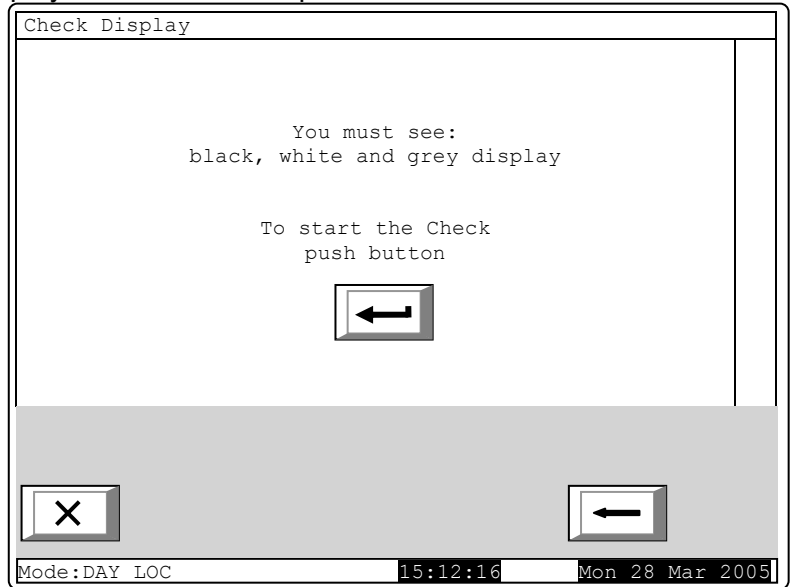





When you press button  that is in the middle of the display, the check is being started – the display changes its colour from black to white and then to grey. Each colours remains for about 4 s. After the check is completed, the initial screen appears.

13.8.5. Menu *Buttons*

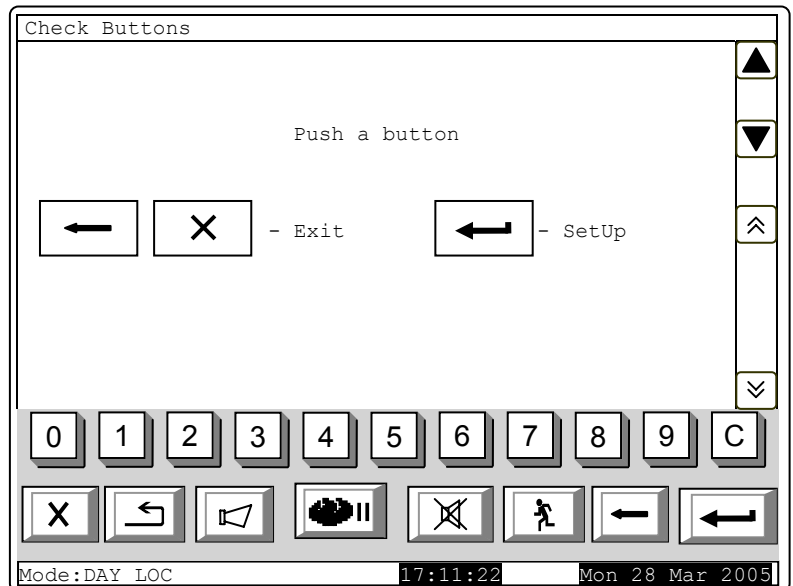
The menu is used for check-up and set up of the buttons situated on the LCD display of the control panel.

Enter the menu to display:



When a random button is pressed (except for buttons ,  and ) a message and a graphic image of the presses button appear:

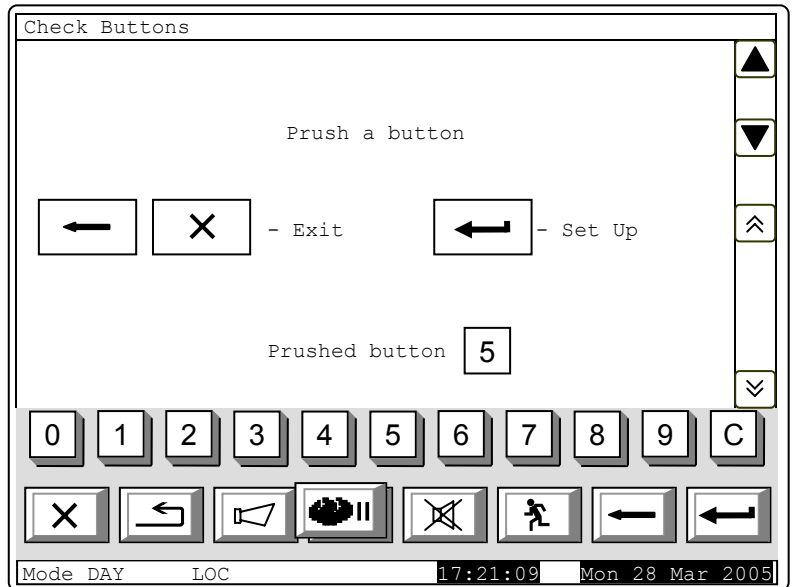

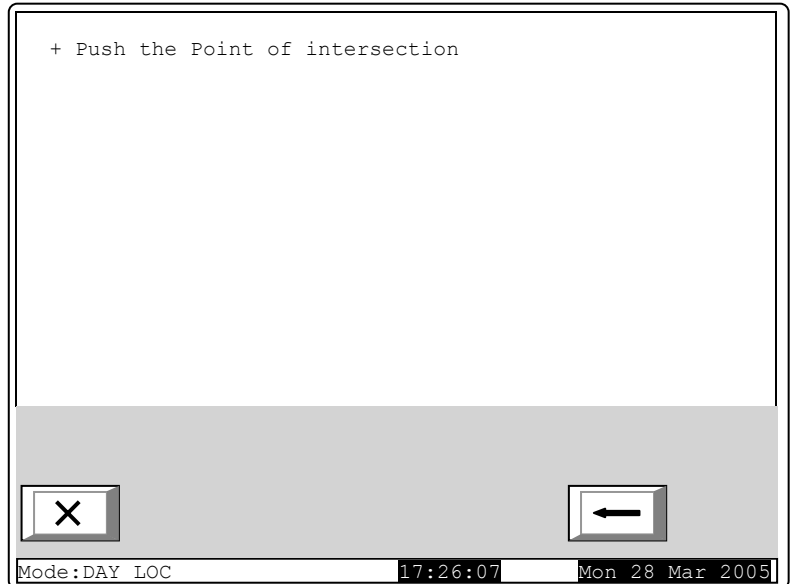

To start setting the buttons up, press button . Set up is being performed at two points on the display and is being checked at two points. Enter the function to display the first point of set up:

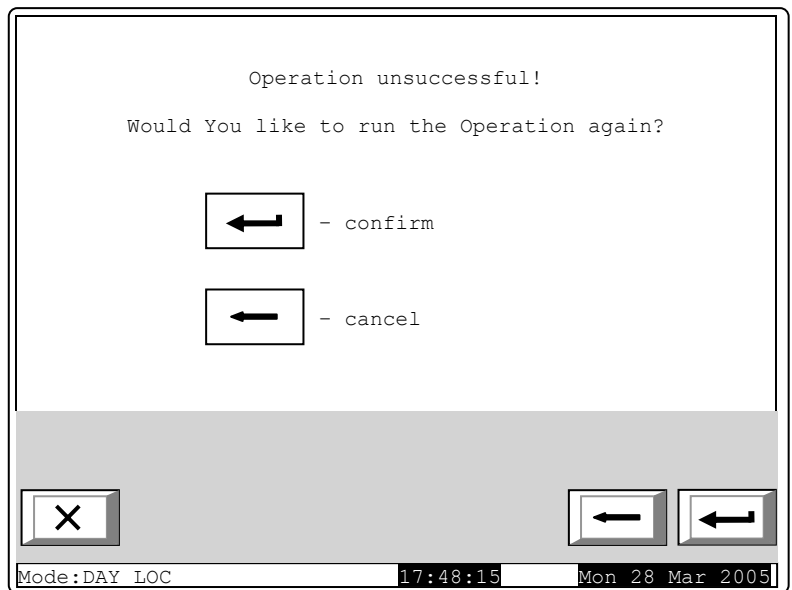

Push the point of intersection with the stylus.  
Do the same for the second, third and fourth points.

If the check performed at the third point and the fourth point is checked and if it is successful the function is exited automatically. In case the performed check at point three is unsuccessful, the first adjustment point is displayed on the screen. In case the check at point three is successful, but at point four is not, then a screen with text message for fault condition is displayed:



The check-up can be interrupted at any stage by pressing button  or .

### 13.9. Menu *New passwords*

The menu allows the user to compose and edit passwords for Access Level 2 and Access Level 3. It contains:



- Menu *Level 2*;
- Function *Level 3*.

#### 13.9.1. Menu *Level 2*

The menu allows the user to enter and edit passwords for Access Level 2.

Enter the menu and a screen where you can edit the first password for Access Level 2 appears:

To enter or edit a password use the digit buttons – when you press a button, the digit is inserted over the position of the cursor, and the previous text and the cursor move one position to the right.



Move the cursor to the left or to the right using buttons  and .

Press  to delete:

- The digit under the cursor, if any;
- The digit to the left of the cursor, if no digit is available under the cursor.

The maximum length of the password is 10 symbols. If you press a button after the 10-digit password is entered, the exceeding symbol will not be accepted.

When you press button  the last entered password will be saved in the control panel.

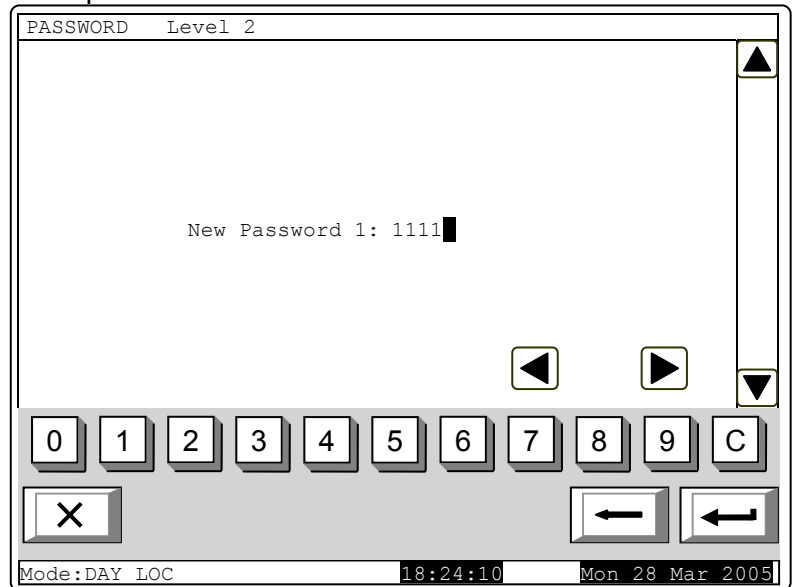

When you press button  or  the previous or the next password will be displayed for edition. Any unsaved passwords will be lost.



#### 13.9.2. Function *Level 3*

The function allows the user to enter and edit a password for Access Level 3:

To enter or edit a password use the digit buttons – when you press a button, the digit is inserted over the position of the cursor, and the previous text and the cursor move one position to the right.

Move the cursor to the left or to the right using buttons  and .

Press  to delete:

- The digit under the cursor, if any;
- The digit to the left of the cursor, if no digit is available under the cursor.

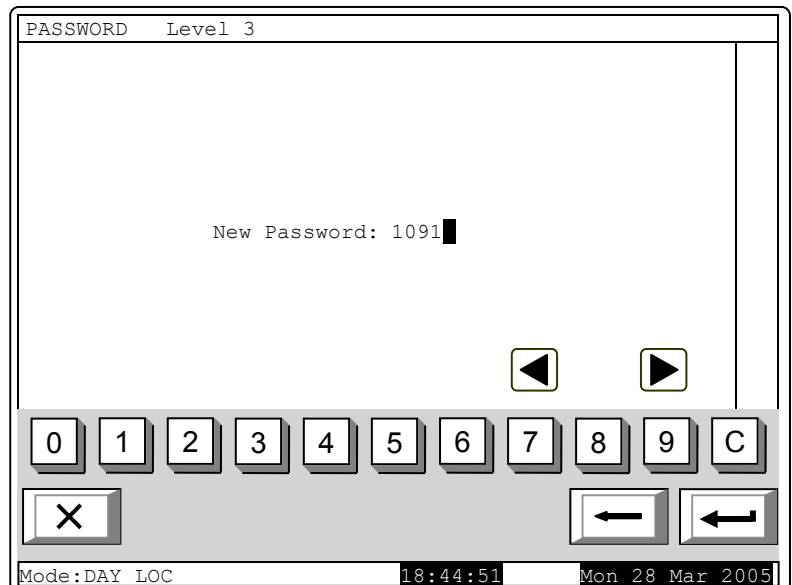

The maximum length of the password is 10 symbols. If you press a button after the 10-digit password is entered, the exceeding symbol will not be accepted.

When you press button  the last entered password will be saved in the control panel.

### 13.10. Function *Default parameters*

The function saves the default parameters of the control panel.

Upon activation the following screen appears:

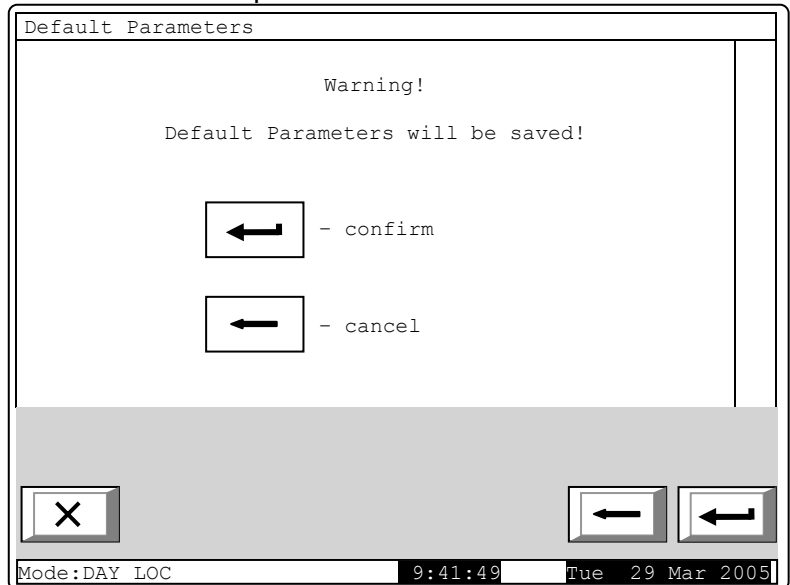

To save the record press button , in the bottom line of the panel appears the message *Wait please...*

Upon unsuccessful operation appears the following screen:

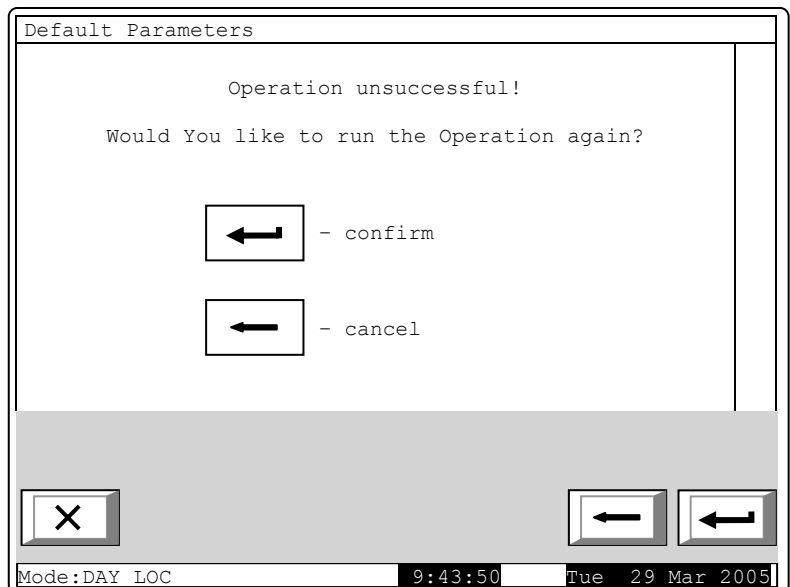

When the records are successfully saved, the menu is exited automatically.

The following default parameters are being saved:

- Control panel parameters:
  - ◆ Local network – On;
  - ◆ Periphery module 1 – none;
  - ◆ Periphery module 2 – none;
  - ◆ Periphery module 3 – none;
  - ◆ Number of zones – 0;
  - ◆ Language– English;
  - ◆ Mode of operation – DAY;
- Loop 1 parameters:
  - ◆ The loop is On;
  - ◆ Number of devices in the loop – 0;
  - ◆ Maximum current in the loop – 200mA;
  - ◆ Addressing – automated.
- Loop 2 parameters:

- ◆ The loop is off;
- ◆ Number of devices in the loop – 0;
- ◆ Maximum current in the loop – 200mA;
- ◆ Addressing – automated;
- Power loop – off;
- Zone 1-250 parameters:
  - ◆ Manual call point priority – yes
  - ◆ Coincidence Mode – no;
  - ◆ Time Fire Phase 1 - Phase 2 – 0s;
  - ◆ Inspection time – 0s;
  - ◆ Number of devices in the zone – 0 (free zone);
  - ◆ Fire Phase 1 outputs – none;
  - ◆ Fire Phase 2 outputs – none;
- Device parameters (Addresses 1 to 125 in Loop 1 and addresses 1 to 125 in Loop 2)
  - ◆ Zone – 255 (not included in a zone);
  - ◆ Device is On;
- Addressable input parameters (Addresses 1 to 125 in Loop 1 and addresses 1 to 125 in Loop 2):
  - ◆ Text message – none;
  - ◆ Activated inputs – none;
- Disables:
  - ◆ zone – none;
  - ◆ devices – none;
  - ◆ outputs – none;
- Zones in test – none.

### 13.11. Function *Clear archive*

The function is provided for deleting the control panel archive.

Upon activation the following warning screen appears:

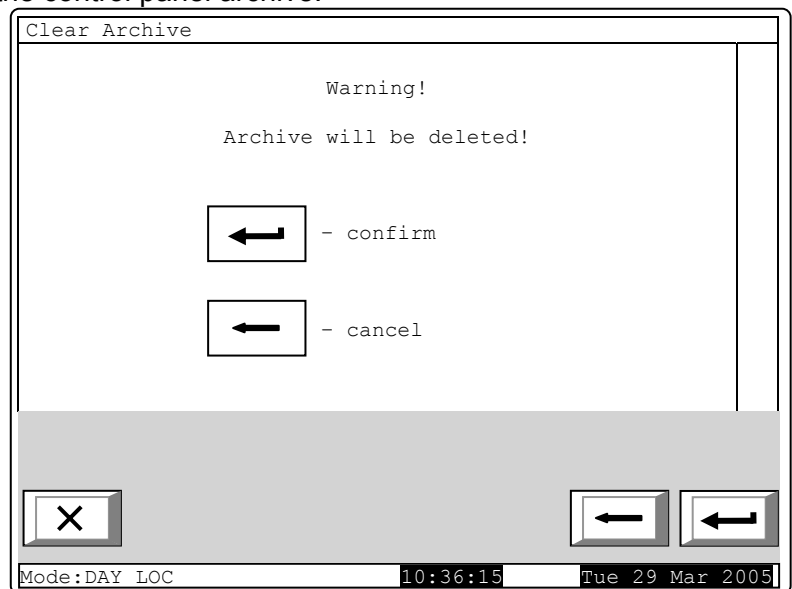

To start deleting the archive press button , in the bottom line of the panel appears the message *Wait please...*

Upon unsuccessful operation appears the following screen:

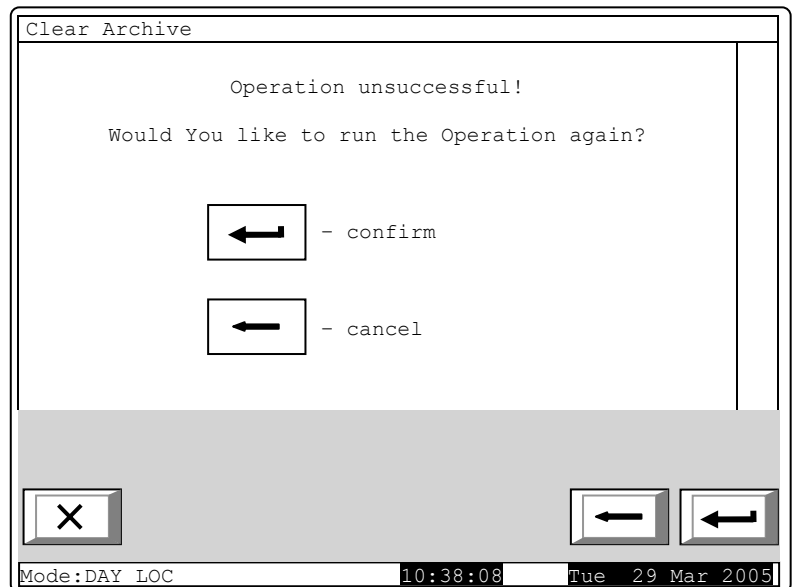

Upon successful operation the menu will be exited automatically.

#### 14. Saving the parameters

All set values for parameters or modes of operation are being saved in the energy independent memory and upon interruption of mains supply or backup batteries supply the values remain intact. After the control panel is switched on again, it starts operation in accordance with values and modes previously set.

Default parameters and modes of operation are factory set up (see section. 13.10).

User passwords are set to:

- Access Level 2 passwords:
  - ◆ Password 1 – 1111;
  - ◆ Password 2 – 2222;
  - ◆ Password 3 – 3333;
  - ◆ Password 4 – 4444;
  - ◆ Password 5 – 5555;
  - ◆ Password 6 – 6666;
  - ◆ Password 7 – 7777;
  - ◆ Password 8 – 8888;
  - ◆ Password 9 – 9999;
  - ◆ Password 10 – 1010;
- Access Level 3 password - 0000.

#### 15. Labour protection requirements

The installation and maintenance staff shall be well grounded in equipment's mechanism and operation, as well as in common technical safety regulations.

Connection to unearthed or to indirectly earthing mains supply is prohibited.

Troubleshoots are to be cleared after disconnecting the feeding cable from the mains supply.

The control panel is designed for installing in premises with a normal fire hazard, as per the Fire Precaution Technical Regulations in Building Construction.

#### 16. Installation and arrangements

When fire detectors and periphery devices are integrated in the system, avoid arranging wires in closed loops; it will reduce the control panel's resistance to electro magnetic interferences

##### 16.1. To mount the fire control panel

- Unpack the device;
- put the dowels on the determined places;
- fasten the control panel to the dowels through the three holes provided on the chassis.

## 16.2. Periphery devices assembly

All connections are to be made by means of terminals, mounted on the printed circuit board 7002-4 loops Main (Appendix 4). Be advised, that the total consumption of the voltage powering the external devices (terminal "+ 28V") plus the consumption of the monitored outputs shall not exceed 5A in heavy duty mode.

### 16.2.1. Mounting periphery devices to monitored outputs

Terminals "+Out1", "-Out1", "+Out2", "-Out2" – monitored potential outputs, responding upon Fire condition (depending on the pre-programmed relation *fire alarm line – monitored outputs*) are to be used.

Use the special connection diagram for the executive device provided in Appendix 6a.

End of line resistors 5k6 are connected directly to the terminals of the unused monitored outputs.

### 16.2.2. Mounting periphery devices to relay outputs

The following terminals are used:

- Terminal "+28V" – positive lead of the stabilized direct current supplying the external devices (light and sound signaling devices, executive devices and others);
- Terminal "GND" – chassis ground (negative lead of the stabilized direct current supplying the external devices);
- Terminals "Rel1/C", "Rel1/NO", "Rel1/NC", "Rel2/C", "Rel2/NO" and "Rel2/NC" – potential free relay contacts, responding at Fire condition (in compliance with the pre-programmed relation *fire alarm line – relay outputs*);
- Terminals "REL Fault/C", "REL Fault/NO" and "REL Fault/NC" – potential free relay contacts. When no fault condition is detected terminals "REL Fault/C" and "REL Fault/NO" are connected; upon detection of fault condition terminals "REL Fault/C" and "REL Fault/NC" are connected.

The executive device shall be connected according to Appendix 6b.

Unused relay outputs remain unoccupied.

## 16.3. Connecting interface devices

### 16.3.1. Global network

Connection of interface devices to the global network is made via serial interface RS232, using 9-lead coupling (Appendix 4). Signals distribution is given in Table.

Table

Coupling's lead	Signal of RS232 Interface	Signal of RS485 Interface
2	RXD (input data)	Inverting input/output
3	TXD (output data)	Non inverting input/output
4	DTR	
5	GND (chassis ground)	

The fire control panel provides power supply to an external modem, if the feature has been included in the customer's order. The power supply is tapped on a two-pole terminal on the PCB *Power supply to modem*.

### 16.3.2. Local network

Connection of interface devices to a local network is made via two serial interfaces CAN 2.0B using the terminals CAN1 and CAN2.

## 16.4. Connecting addressable fire detectors

Addressable fire detectors are connected to the fire control panel by means of two-wire insulated line of total resistance up to 100Ω (Appendix 5a). Connection is made to the terminals of the corresponding fire alarm loops (Appendix 4) observing the indicated polarity (N is the number of other loop).

- "+LoopN-1", "-LoopN-1" and „Ω" for the beginning of the loop;
- "+LoopN-2", "-LoopN-2" and „Ω" for the end of the loop.

In one fire alarm loop a maximum of 125 addressable devices can be included regardless of their type.

Unused fire alarm loops remain free (no connection is made to their terminals).

It is recommended to include addressable devices in closed fire alarm loops (Appendix 5b). If branches of the loop (Appendix 5c) are to be used, the following restrictions shall be observed:

- do not connect a branch between the control panel and the first/last device in the loop (Appendix 5d);
- do not connect two or more branches between two consecutive devices in a loop (Appendix 5e).

Addressable output modules supplied by the power loop shall be connected to it by means of two-wire insulated line of total resistance not more than  $10\Omega$  (Appendix 5a). Connection is made to the terminals of the power loop (Appendix 4) observing the indicated polarity:

- “+PowerL-1” and “-PowerL-1” for the beginning of the loop;
- “+PowerL -2” and “-PowerL -2” for the end of the loop.

### 16.5. Power supply connection

Take out the fuse from the terminal with mains fuse (Appendix 3).

Connect a feeding cable to the terminal with mains fuse, observing the following positions (Appendix 3):

- P – power wire “Phase”;
- N – power wire “Null”;
- $\Omega$  - safety ground wire.

The cable shall be double insulated and of  $0,5\text{mm}^2$  section for the power supply wires, and of  $1,5\text{mm}^2$  section for the safety ground wire.

The other end of the feeding cable is connected to the mains power supply by means of junction box.

The mains power supply of the fire control panel shall be in a separate loop.

## 17. Fire control panel start up

### 17.1. Sequence of start up

Make sure that the connection to mains power supply is properly made.

Make sure that the periphery devices are correctly connected.

Place the fuse in the terminal with mains fuse, the display illuminates and appears the text *System operations*.

Connect the feeding cable and the backup batteries; the batteries shall be in a series connection.

Connect the red wire to the positive backup battery pole, and the blue wire - to the negative pole.

The overall voltage of both batteries shall not exceed 17.6V, otherwise the fire control panel will not recognize them.

The fire control panel enters Duty Mode.

The local fire control panel (base PC board) is active.

Enter SetUp Mode and configure the control panel as follows:

1. Save the default parameters (except for a control panel with factory set up parameters) – Function Default parameters (see section 13.10);
2. Select a language for the messages – Menu Panel configuration (see section 13.2);
3. Set the loop parameters – Menu Loop parameters (see section 13.4.1):
  - ◆ Loop status – On or Off;
  - ◆ loop addressing – automated;
4. Clean initialization of fire alarm loops is performed (see section 17.2);
5. The text message for addressable devices in the loops is entered – Menu *Device Parameters* (see section 13.4.2);
6. Fire alarm zones are formed and their parameters are adjusted – Menu *Zones* (see section 13.5):
  - Devices in the zone – Menu *Devices* (see section 13.5.1);
  - Outputs associated to the zone – Menus *Fire Phase 1 Outputs* and *Fire Phase 2 Outputs* (see section 13.5.2);



- Zone parameters: Manual call point priority, Coincidence Mode, Time Fire Phase 1 – Phase 2 and Inspection time – Menu *Zone parameters* (see section 13.5.3);
  - If the panel is a part of network and addressable outputs will be activated, in “Fire” mode in remote panel should be made setup of the service remote panel and her zone- Menu “*Service Rem. Zones t*”;
  - The text message, relevant to the zone – Screen *Text message* (See 13.5.5);
7. Parameters of addressable inputs are adjusted, if any – Menu *Inputs* (see section 13.6);
  8. Power Loop is switched on if needed – Menu (see section 13.2);
  9. Passwords for access to Level 2 and Level 3 are entered – Menu *New passwords* (see section 13.9);
  10. Archive is cleared – Function *Clear archive* (see section 13.11).
- Upon exit of Set Up Mode the fire control panel runs all system operations and enters Duty Mode – the control panel is ready to fire protect the site.
11. The active fire control panel is changed from Local to Remote (menu *Lists/Select Local/Remote*).
  12. The menus to operate the loops PC board are visualized on the display.
  13. The parameters of the remote fire control panel and the loops (the second pair of loops) are set up as described in the previous points.
  14. After the remote fire control panel is setup select again the active one to be the local fire control panel (base PC board), as it is defined to be the Master.
- Note: Press the Reset button to restore the factory settings of the remote fire control panel (Appendix 3).

## 17.2. Clean initialization of loops

A few methods for initialization of loops can be applied depending on the selected method of addressing.

### 17.2.1. Clean initialization of loops with automated addressing

To perform initialization of loops with automated addressing it is necessary:

- The fire control panel shall be installed on site and fire alarm loops with included addressable devices are connected;
- Loops that will be initialized shall be switched on and set to automate addressing (see section 18.1-3).

In such case actions relevant to section 18.1-4 shall be:

If the control panel is using default settings, when started, it will automatically begin clean initialization of fire alarm loops (by default both loops are set to automate addressing). If in the fire alarm loops that will remain set to automate addressing, no devices will be switched off, (i.e. addresses reserved in case new devices will be added later), it is necessary to check the result of this initialization:

- The number of detected devices in the loop is checked – Menu *Loop parameters* (see section 13.4.1);
- The initialization of addressable devices in the loops that will remain set to automate addressing is checked– Menu *Check* (see section 13.7.5).

When the results comply with the physical configuration of the loops, then the clean initialization has been performed successfully. In other case the clean initialization shall be repeated, following the description below:

Clean initialization of a loop set to automate addressing is performed according to the sequence:

1. If a fire alarm loop is set to manual addressing, it shall be switched off – Menu *Loop parameters* (see section 13.4.1);
2. If any uncharged devices are detected in the loops, they shall be disabled – Menu *Exclude devices* (see section 13.7.4);
3. Each fire alarm loop set to automate addressing shall undergo loop check – Function *Check up* (see section 13.4.4). If the check confirm short circuit or break in the loop, or the number of devices and branches does not comply with the physical configuration of the loop, then the faults shall be eliminated and the check shall be run again;

4. Fire alarm loops set to automate addressing shall undergo clean initialization of their addressable devices – Function *Clean initialization* (see section 13.7.2);
5. Initialization of addressable devices in loop set to automate addressing is checked – Menu *Check* (see section 13.7.5);
6. If the configuration of certain loop does not comply with the desired configuration, the addressable devices shall be re-arranged in a suitable way, then the activities of section 2 to 5 (in this case when repeating section 2 you will have to disable and enable the devices)
7. Fire alarm loops that are set to manual addressing shall be switched on – Menu *Loop parameters* (see section 13.4.1);

#### 17.2.2. Clean initialization of loops set to manual addressing

To perform clean initialization of a loop set to manual addressing, it is necessary to switch on the loops and to set then to manual addressing (see section 18.1-3).

Clean initialization of a loop set to manual addressing may be done in two ways – when the fire control panel is not installed yet and when it is already installed on site.

##### 17.2.2.1. Clean initialization before the control panel is installed on site

The unpacked fire control panel shall be connected to a temporary power supply, according to the description in section 17.5. A base for automate fire detector, leads for manual call point and for addressable input module, output module and input-output module shall be connected to Line 1 of the loop which shall undergo initialization (clamps Loop 1-1 or Loop 2-1). No device is connected to the leads of the other loop. The fuse is placed in the clamp with network fuse, the display shall illuminate and a text, *System operation*, shall appear.

Clean initialization of loops set to manual addressing shall be performed following the sequence:

1. Enter *Set Up Mode*;
2. Disable some devices if needed – Menu *Exclude devices* (see section 13.7.4);
3. Adjust the loop parameters – Menu *Loop parameters* (see section 13.4.1):
  - Loop status – On;
  - Loop maximum current;
  - Number of devices connected to the loop – 0;
  - Loop addressing – manual;
4. Clean initialization is started for the specified loop set to manual addressing – Function *Manual addressing* (see section 13.4.5);
5. An automate fire detector is placed onto the base, or to the previously prepared leads connect manual call point or addressable input module, output module and input-output module;
6. The addressable device shall be initialized the same way as described in section 13.4.5, paying attention not to duplicate addresses;
7. The initialized addressable device is removed from the loop and the address and the loop are marked on the device;
8. 5, 6 and 7 shall be repeated for all devices, which will be connected to the loop.

The fuse is removed from the clamp with network fuse. If needed, the other loop can be initialized the same way. The fire control panel shall be disconnected from the temporary power supply source.

The fire control panel and the devices are then mounted on site (see section 17). The fire control panel is started up according to the sequence described in 18.1, observing these specifics:

- Before entering *Set Up*, a check for fault conditions of devices that has undergone clean initialization upon manual addressing in the loops shall be performed. If any faults are detected, causes shall be eliminated and the fire control panel shall be re-started. If any addresses have remained switched on, they can be switched off later;
- Activities in compliance with section 18.1-4 are the following:
  - a) Switch off any omitted addresses – Menu *Exclude devices* (see section 13.7.4);
  - b) Check the initialization of the addressable devices in the loops set to manual addressing – Menu *Check* (see section 13.7.5);
  - c) If the configuration of any loop does not comply with the desired configuration, the addressable devices shall be re-arranged accordingly and standard initialization of the loop is performed – Function *Initialization* (see section 13.7.1).

Note: The second loop can be switched off during this operation, if it will not be initialized again, then switched on again – Menu Loop parameters (see section 13.4.1);

d) Activities set in b) and c) are repeated until the desired configuration is achieved.

#### 17.2.2.2. Clean initialization of fire control panel already installed on site

In such case to the fire alarm loop, set to manual addressing, can be:

- Connected all addressable devices – for a successful initialization, at one point (i.e. between two serial devices) not more than one branch is acceptable;
- Addressable devices may not be connected at all – no limits are set to the loop configuration if it is going to always work in manual addressing mode;
- Part of the addressable devices may be connected (for example, manual call points, addressable input modules, output modules, input-output modules), and the rest (for example, automated fire detectors) may not be connected – for a successful initialization, the fire control panel shall not have access to more than two uninitialized devices in either line of the loop; i.e. if at one point are present more than one branch, the uninitialized devices can be only in two branches (in the loop and one branch, or in two branches only)

Clean initialization of loops set to manual addressing (activities according to section 18.1-4) is performed following the sequence:

1. Any devices may be switched off, if needed – Menu *Exclude devices* (see section 13.7.4);
2. The number of devices connected to the loop is set to 0 – Menu Loop parameters (see section 13.4.1);
3. Start a clean initialization in manual addressing mode for the particular fire alarm loop – Function Manual addressing (see section 13.4.4);
4. Each device connected to the loop is initialized, one by one, as described in 13.4.4;
5. All other devices are connected, one by one – automate fire detectors are placed onto their bases, manual call points, addressable input, output, input-output modules are connected to the provided leads – and are initialized according to the description in 13.4.4;
6. The initialization of the addressable devices in the loops set to manual addressing is checked – Menu *Check* (see section 13.7.5);
7. If the configuration of any loop does not comply with the desired configuration, the addressable devices shall be re-arranged accordingly and standard initialization of the loop is performed – Function *Initialization* (see section 13.7.1).

Note: The second loop can be switched off during this operation, if it will not be initialized again, then switched on again – Menu Loop parameters (see section 13.4.1);

8. Activities set in 6 and 7 and are repeated until the desired configuration is achieved.

### 17.3. Additional function built-in IFS7002-4 signal loops

In IFS7002-4 signal loops an option is provided to enable and disable the password for suppressing and disabling the activated outputs in Fire condition. To use this option in the fire control panel enter menu: *Setup/New passwords/Options*. The following screen for setting the option appears.

Use the button  to correct the parameter– press it to change alternatinly its value:

- Yes – a password for suppressing/disabling the activated outputs in Fire condition is required.

- No – a password for suppressing/disabling the activated outputs in Fire condition is not required.

Press the button  to save the selected parameter in the fire control panel.

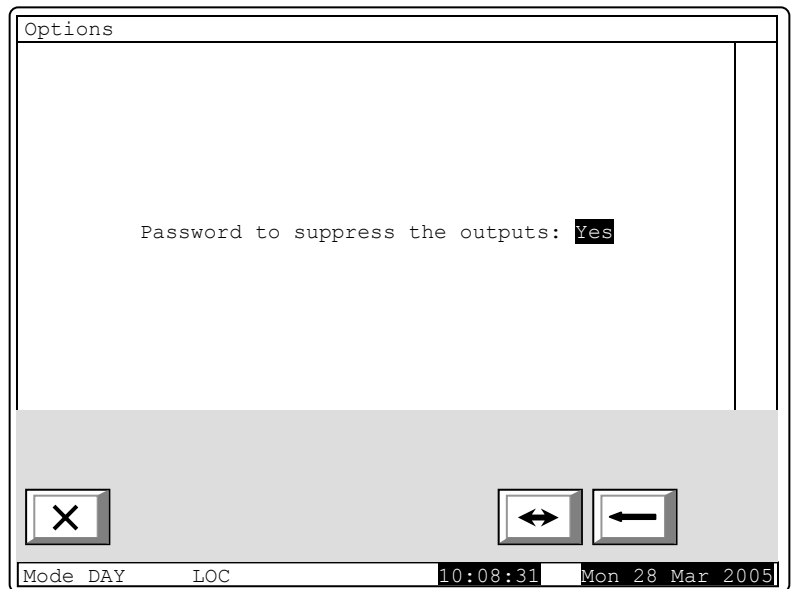





**Attention!!!**

The activation of this function (a password for suppressing/disabling the activated outputs in Fire condition not to be required.in IFS7002) is not in conformity with the European Standard EN54-2 and it must not be used in the countries where that standard is valid.

**18. Troubleshooting**

Possible problems and methods of troubleshooting are described in Table 3.

**Table 3**

Trouble	Indication	Troubleshooting
Fatal system error	Indicators  and  illuminate in steady yellow light; the local sounder releases continuous signal	The trouble shall be fixed in Technical Service and Maintenance Department
Low backup batteries due to interrupted mains power supply	The local sounder releases discontinuous signal (1s sound, 3s break); the message <i>Battery Low</i> appears on the screen; the backlight of the display is off	Restore the mains power supply or replace the backup batteries
Short circuit or Open loop	Indicator  illuminates in continuous yellow light; the local sounder releases discontinuous signal; information table with the number of faults appears on the display	Eliminate the fault (short circuit or open loop)
Activated isolator of addressable device	Indicator  illuminates in continuous yellow light; the local sounder releases discontinuous signal; information table with the number of faults appears on the display	Eliminate the fault (short circuit in the loop)
Fault condition Uninitialized loop	Indicator  illuminates in continuous yellow light; the local sounder releases discontinuous signal; information table with the number of faults appears on the display	<ul style="list-style-type: none"> <li>- Eliminate the fault (open loop);</li> <li>- Restore the loop so it complies with the configuration saved in the controlpanel and start initialization of the control panel;</li> <li>- Start clean initialization of the control panel</li> </ul>













Trouble	Indication	Troubleshooting
Fault Exceeding number of devices in the loop, Uninitialized device, Exchanged devices, Different ID number of device, Different device type, Different device temperature class	Indicator  illuminates in continuous yellow light; the local sounder releases discontinuous signal; information table with the number of faults appears on the display	<ul style="list-style-type: none"> <li>- Restore the loop so it complies with the configuration saved in the controlpanel and start initialization of the control panel;</li> <li>- Start clean initialization of the control panel</li> </ul>
Fault Removed device	Indicator  illuminates in continuous yellow light; the local sounder releases discontinuous signal; information table with the number of faults appears on the display	Instal the device
Fault Communication error with the device or Fault in device	Indicator  illuminates in continuous yellow light; the local sounder releases discontinuous signal; information table with the number of faults appears on the display	Repair or replace the device (if you replace the device then run clean initialization of the control panel)

Table 3 continued

Trouble	Indication	Troubleshooting
Fault Contaminated sensor (only in detectors with optical-smoke part)	Indicator  illuminates in continuous yellow light; the local sounder releases discontinuous signal; information table with the number of faults appears on the display	Remove the detector and clean the optical part and place it again.
Fault in monitored output	Indicator  illuminates in continuous yellow light; the local sounder releases discontinuous signal; information table with the number of faults appears on the display	<ul style="list-style-type: none"> <li>- Eliminate the fault (short circuit or break) in the line of the monitored output or of the executive device;</li> <li>- Upon break check for a short-circuited element in the monitored output to a grounded wire (see also Short circuit to grounded wire)</li> </ul>
Fault in mains supply	Indicators  and  are illuminated in steady yellow light; the local sounder produces discontinuous signal; information table with the number of faults appears on the display	<ul style="list-style-type: none"> <li>- Restore the mains supply;</li> <li>- Replace the 4A fuse with mains fuse (Appendix 3)</li> </ul>
Fault in backup batteries supply	Indicators  and  are illuminated in steady yellow light; the local sounder produces discontinuous signal; information table with the number of faults appears on the display	<ul style="list-style-type: none"> <li>- Place or change the backup batteries</li> <li>- Replace the burnt fuse 6,3A</li> </ul>

Trouble	Indication	Troubleshooting
Fault in supply to external devices	Indicator  illuminates in continuous yellow light; the local sounder releases discontinuous signal; information table with the number of faults appears on the display	Eliminate the overload to the supply of the external devices
Short circuit to grounded wire	Indicator  illuminates in continuous yellow light; the local sounder releases discontinuous signal; information table with the number of faults appears on the display	Eliminate the short circuit
Fault in internal supply devices	Indicator  illuminates in continuous yellow light; the local sounder releases discontinuous signal; information table with the number of faults appears on the display	The trouble shall be fixed in Technical Service and Maintenance Department

## **19. Conditions of operation, storage and transportation**

### **19.1. Operation and storage**

The fire control panel shall operate and be kept in closed premises, under the following conditions:

#### 19.1.1. Temperature

- storage - from 5°C to 35°C
- transportation - from minus 10°C to 50°C
- operational - from minus 5°C to 40°C

#### 19.1.2. Relative humidity

- storage - to 80%
- operational - to 93%

### **19.2. Transportation**

The fire control panel shall be transported by vehicles, in factory packing, in the above stated environmental conditions and at sinusoidal vibrations with acceleration amplitude not more than 4,9m/s<sup>2</sup> in frequency range 10 to 150Hz.

## **20. Warranty**

The producer guarantees compliance of the device with EN 54-2:1997 /A1: 2006 /AC: 2009, EN54-4:1997 /A2:2006 /AC:2009. The warrant period is 18 months from the date of the purchase, providing that

- the conditions of storage and transportation have been observed;
- the startup has been done by authorized personnel only
- the requirements for operation stated herein have been observed.

***UniPOS wishes you a successful work!***

#### UniPOS

47, "San Stefano" Str., 5800 Pleven, BULGARIA  
phone +359 64 891111, +359 64 891 100, fax +359 64 891 110  
e-mail: office\_pleven@unipos-bg.com

Mladost 1, bl.79B, entr.2, ap.17, 1784 Sofia, BULGARIA  
phone/fax +359 2 9744469, +359 2 9743925  
e-mail: office\_sofia@unipos-bg.com

www.unipos-bg.com

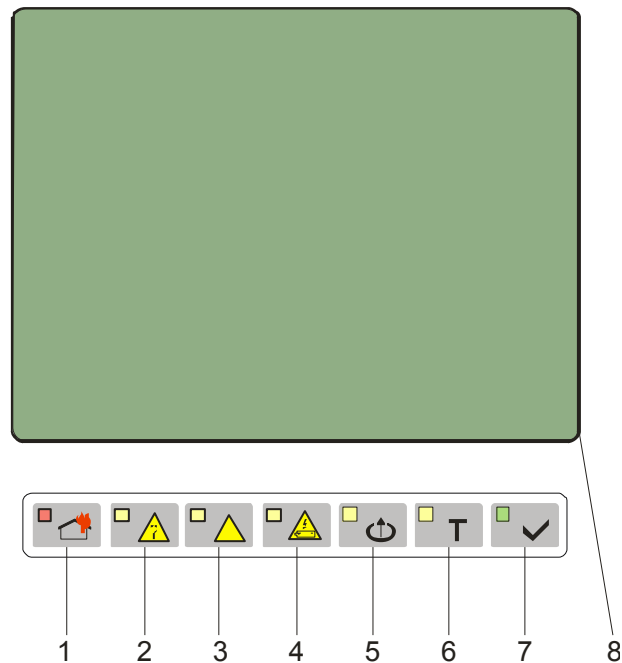
**21. Appendixes****Appendix 1**

- 1 Common indicator for fire condition
- 2 Common indicator for fault condition
- 3 Indicator for *System error*
- 4 Indicator for *Fault in power supply*
- 5 Indicator for *Disabled component*
- 6 Test indicator
- 7 Indicator for *Power supply*
- 8 LCD display

Front panel of IFS7002 four signal loops

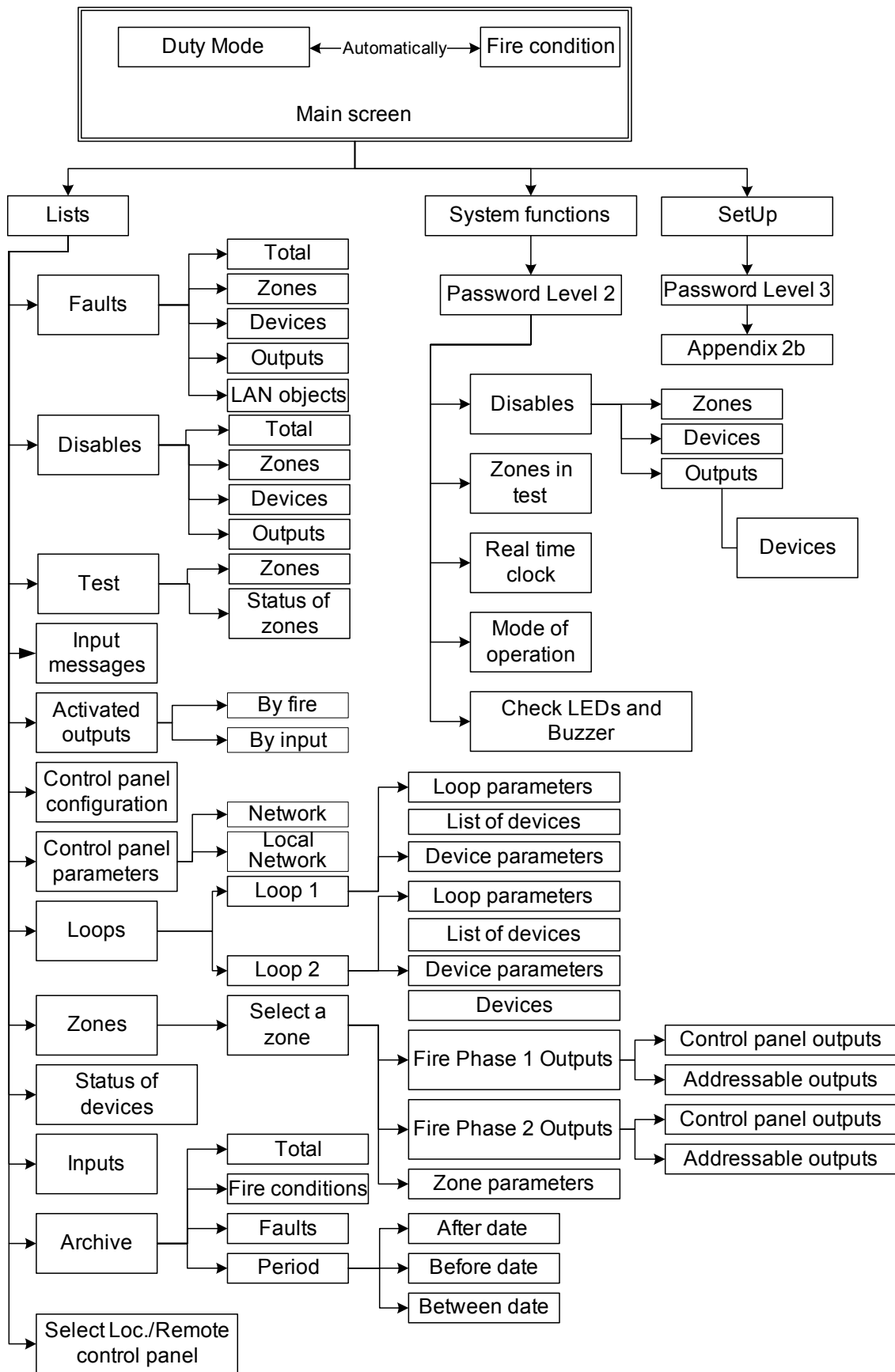

a) Main menu



Appendix 2 continued

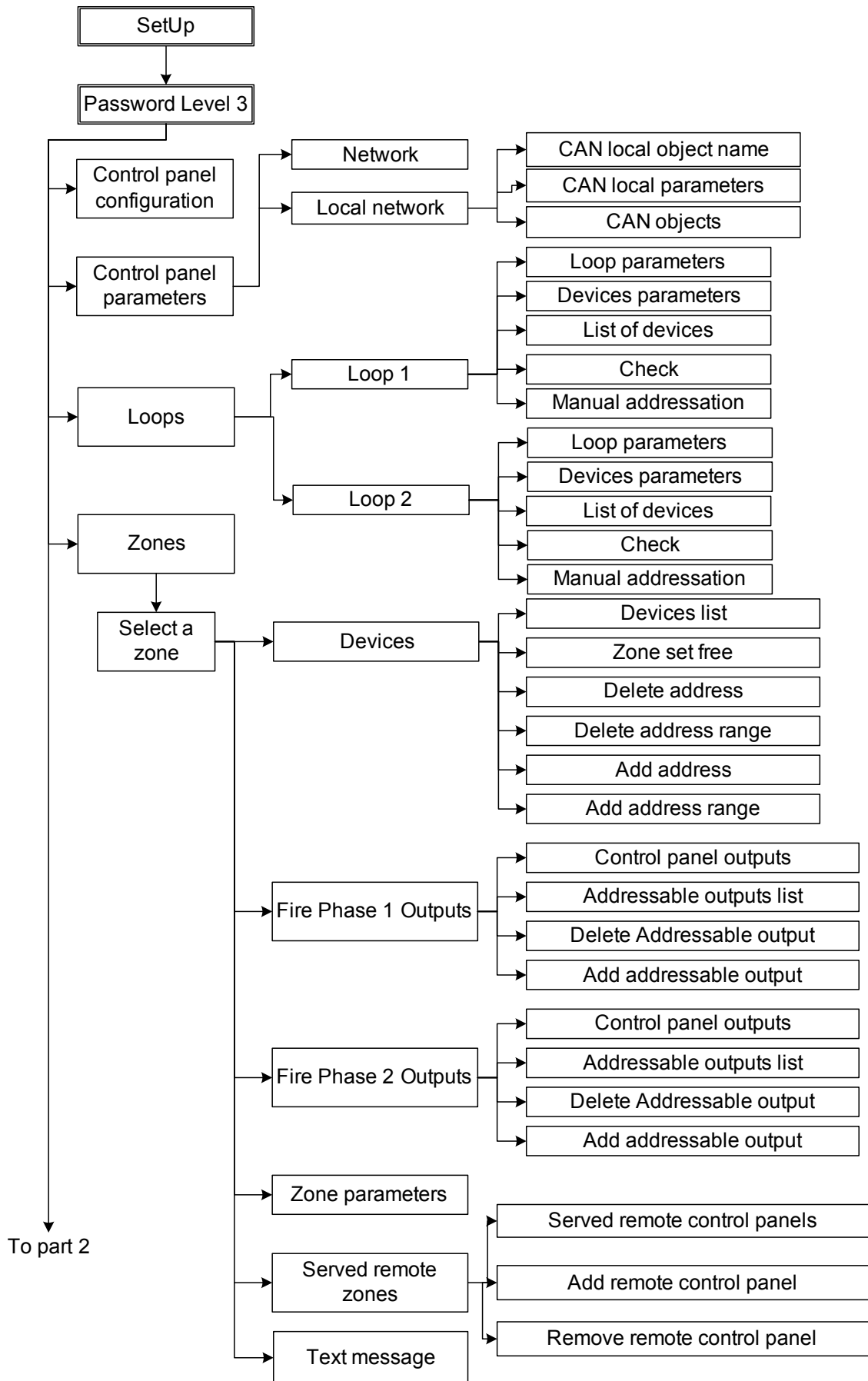

b) SetUp menu (part 1)

Appendix 2 continued

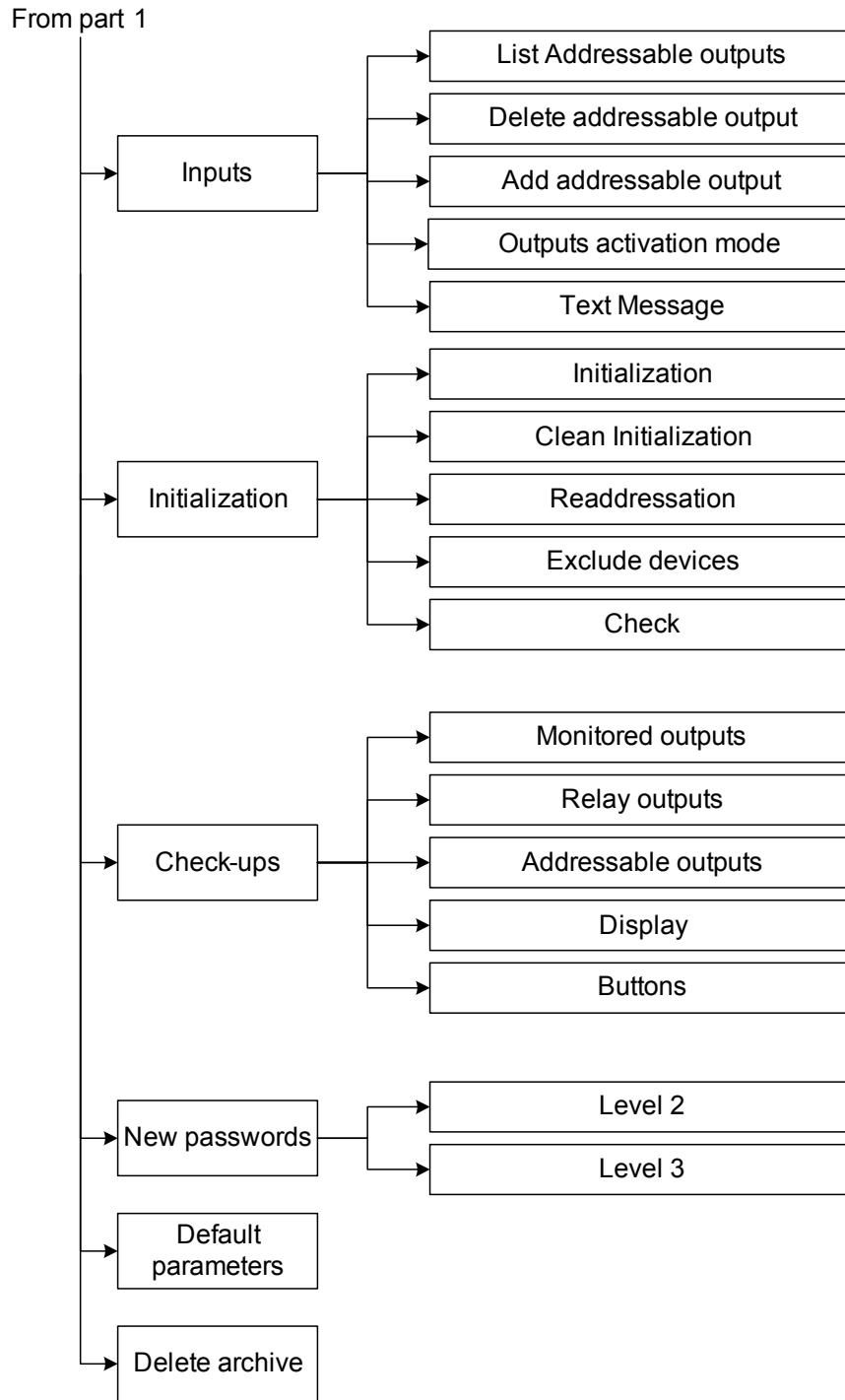

b) SetUp menu (part 2)

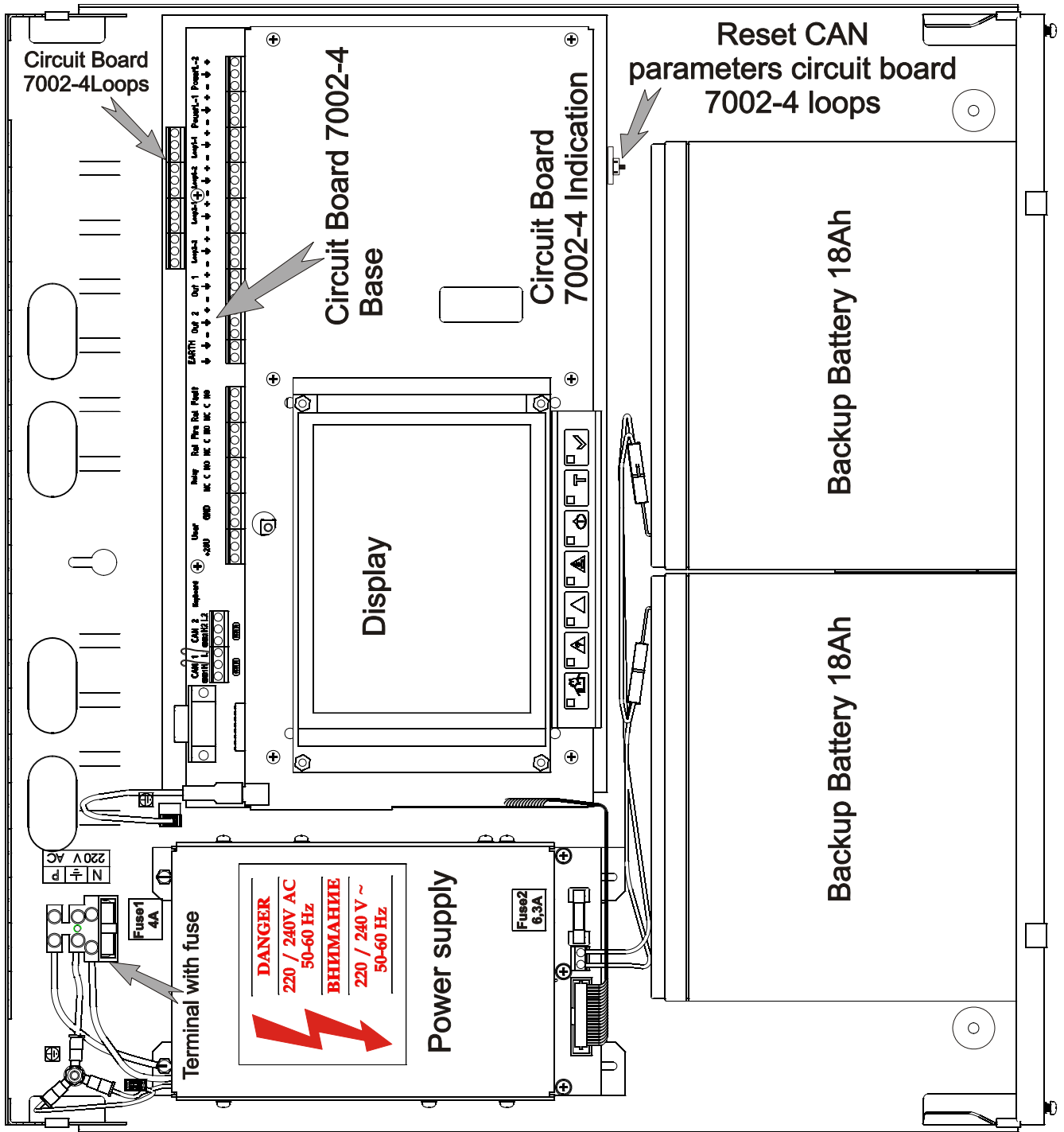

General assembly diagram

Appendix 4

	BASE	LOOPS
	<p>RS232 – standard 9-lead coupling for RS232 serial interface</p> <p>CAN 1 – terminals for CAN 2.0B serial interface</p> <p>CAN 2 – terminals for CAN 2.0B serial interface</p> <p>JP 1 – jumper to end CAN1</p> <p>JP 2 – jumper to end CAN2</p> <p>Keyboard – PS2 standard coupling for external keyboard</p> <p>User                      +28V – voltage for supply to external devices                      GND – positive lead                      GND – negative lead</p> <p>Rel X                      C – relay contact for fire condition № X                      NO – common contact                      NC – normally open contact                      NC – normally closed contact</p> <p>Rel Fault                      C – relay output for fault condition                      NO – common contact                      NC – normally open contact                      NC – normally closed contact</p> <p>Out X                      “+” – leads for monitored output № X                      “-” – positive lead                      “Ω” – negative lead                      “Ω” – earthing</p> <p>LoopX-1                      – beginning of fire alarm loop № X                      “+” – positive lead                      “-” – negative lead                      “Ω” – earthing</p> <p>LoopX-2                      – end of fire alarm loop № X                      “+” – positive lead                      “-” – negative lead                      “Ω” – earthing</p> <p>PowerL-1                      – beginning of power loop                      “+” – positive lead                      “-” – negative lead</p> <p>PowerL-2                      – end of power loop                      “+” – positive lead                      “-” – negative lead</p>	<p>terminals for CAN 2.0B serial interface</p> <p>terminals for CAN 2.0B serial interface</p> <p>terminals for CAN 2.0B serial interface</p>

Terminals and couplings of PCB 7002 Main

Appendix 5

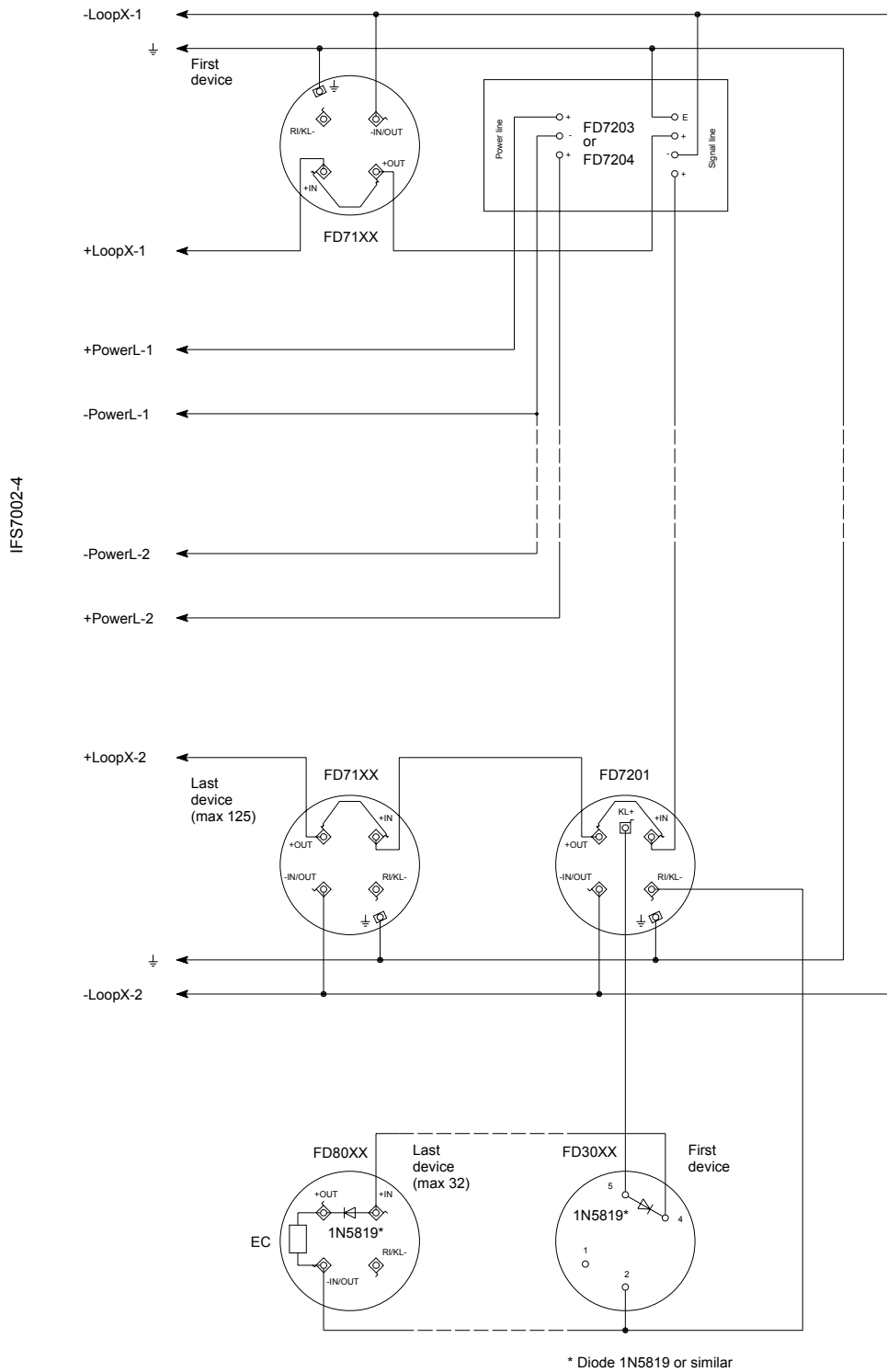

a) Connection of addressable devices to fire alarm loop and power loop

Appendix 5 continued

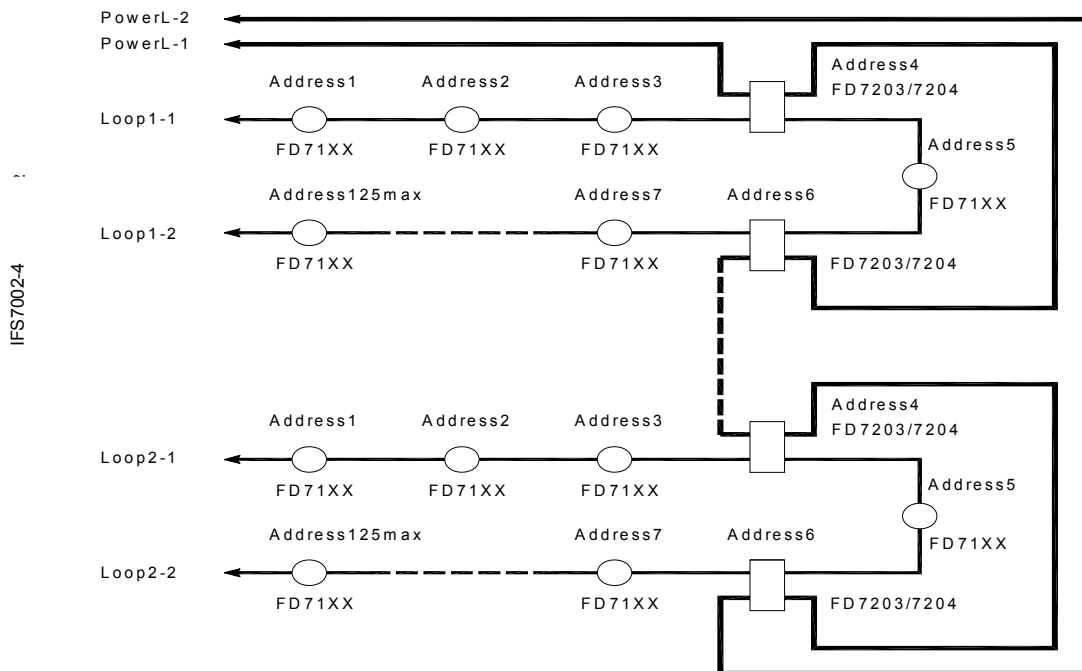

b) Configuration of Fire Alarm Loops without branches and Power Loop (recommended)

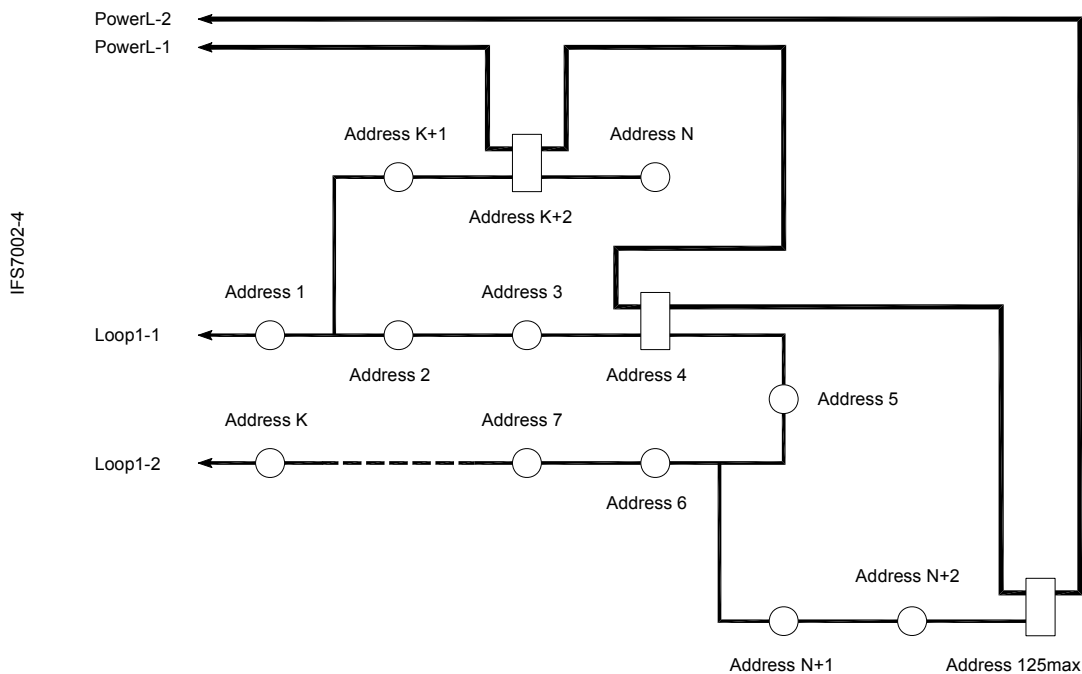

c) Configuration of Fire Alarm Loop with branches and Power Loop (Proper connection)

Appendix 5 continued

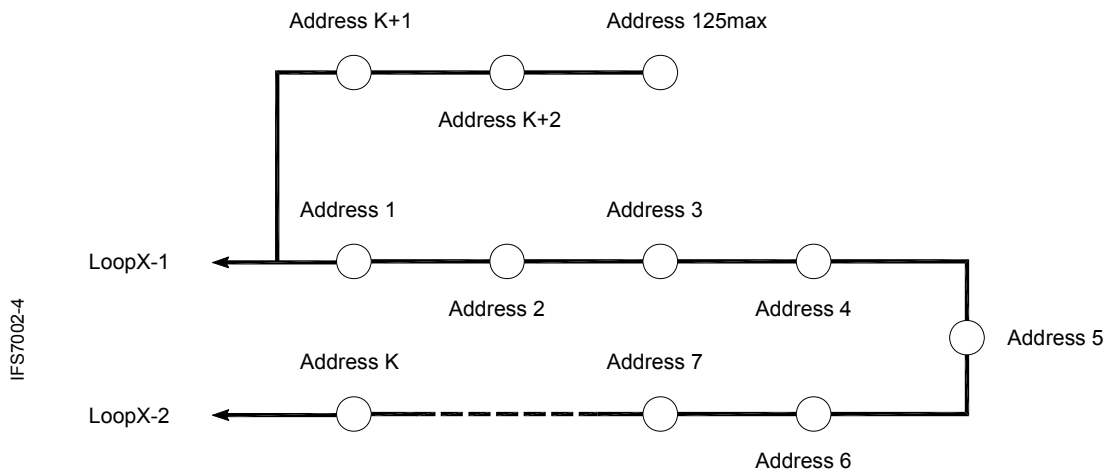

d) Improper connection of Fire alarm loop branch  
(the branch is connected between the control panel and an addressable device)

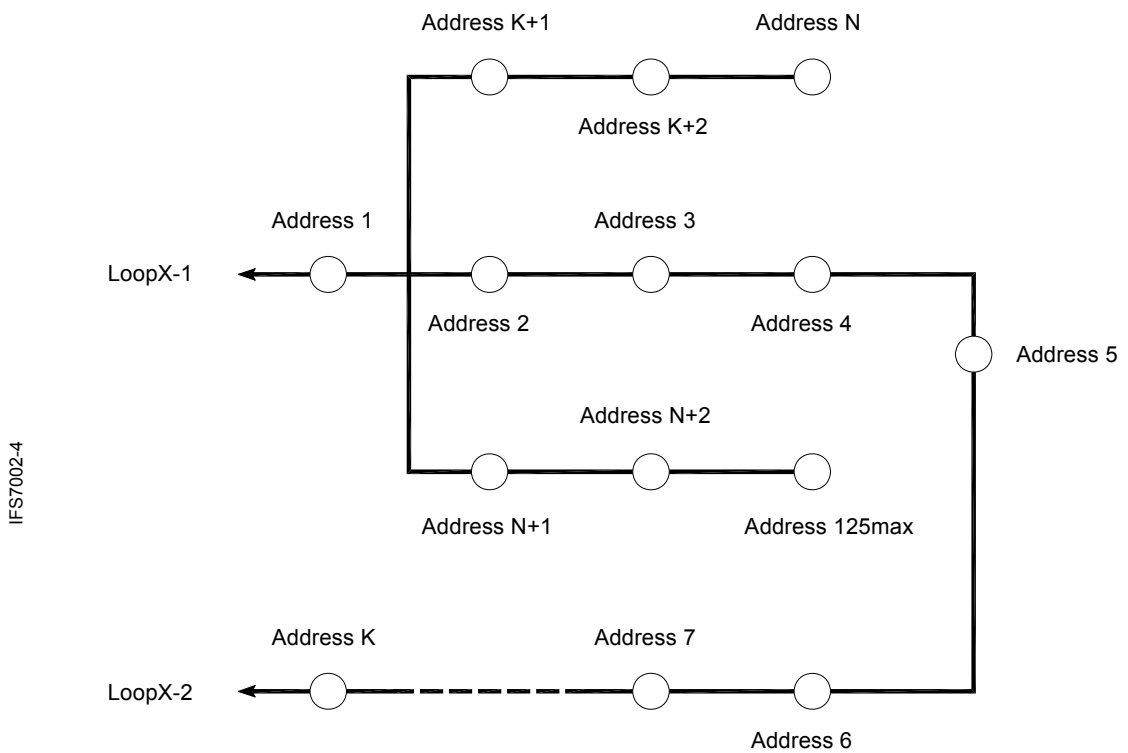

e) Improper connection of Fire alarm loop branches  
(two branches are connected between two addressable devices)

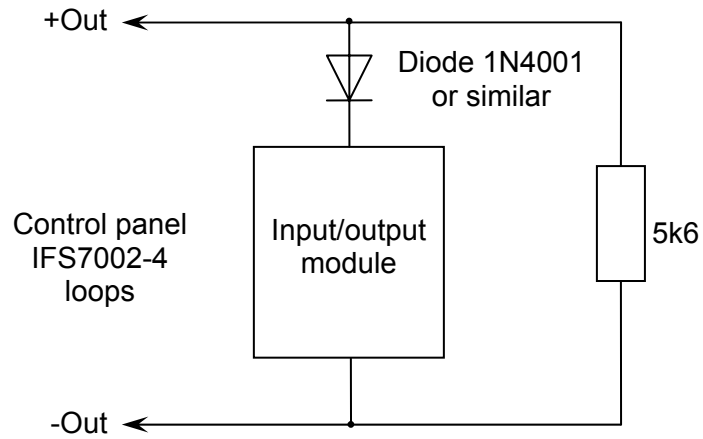

a) Diagram for connecting Input/output module to monitored output

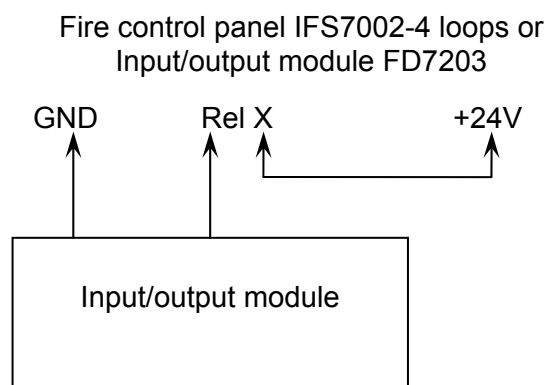

b) Diagram for connecting Input/output module to relay output

Connection diagrams for Input/output module



Appendix 7

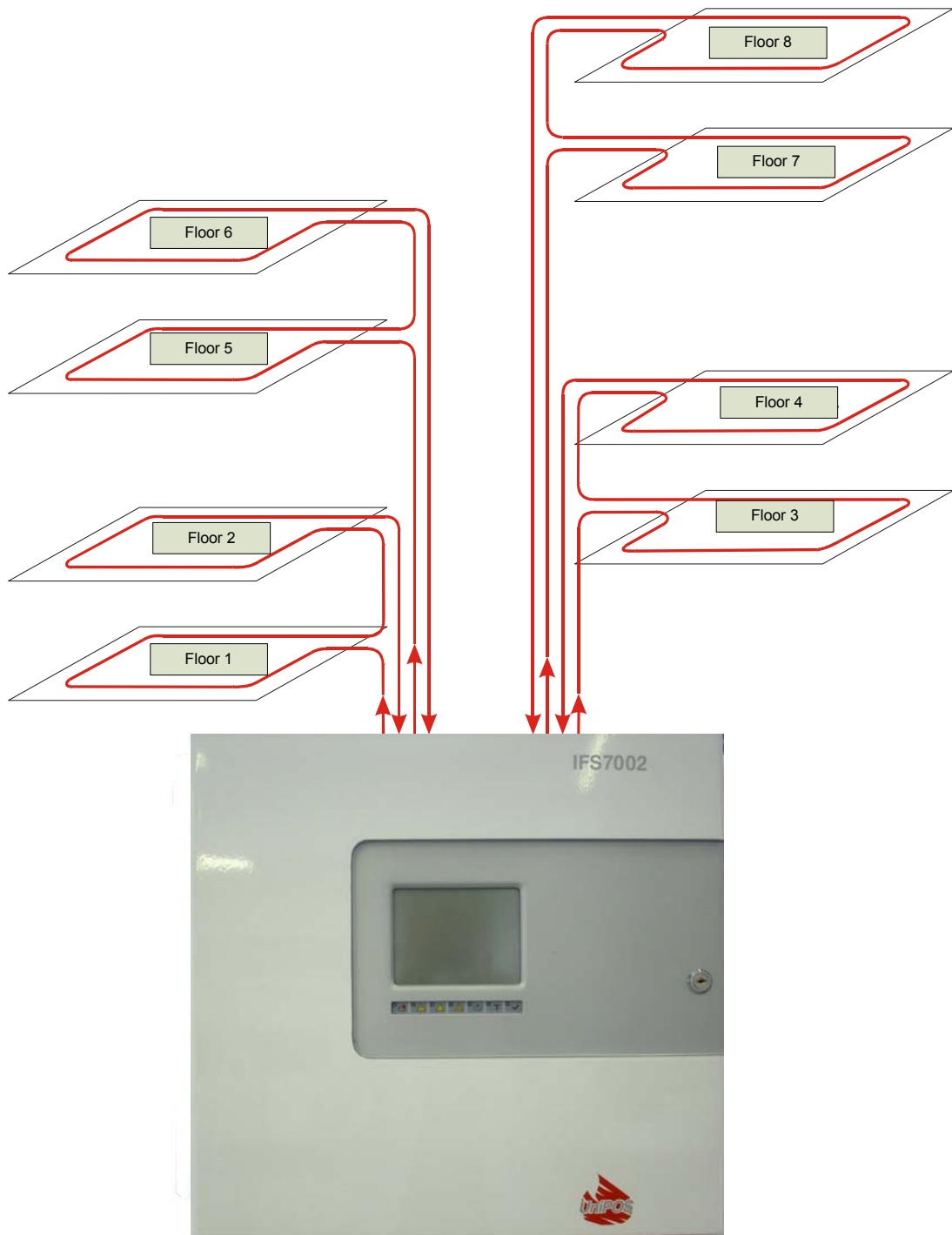

Block diagram of fire alarm installation designed on the base of IFS7002-4 signal loops

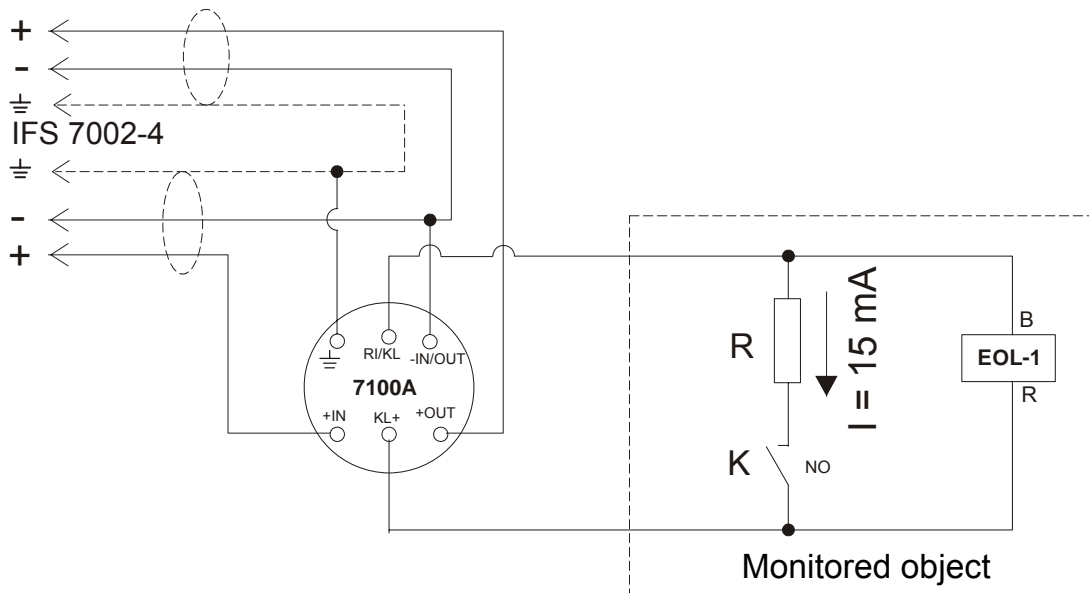

FD7201 connected to monitored input

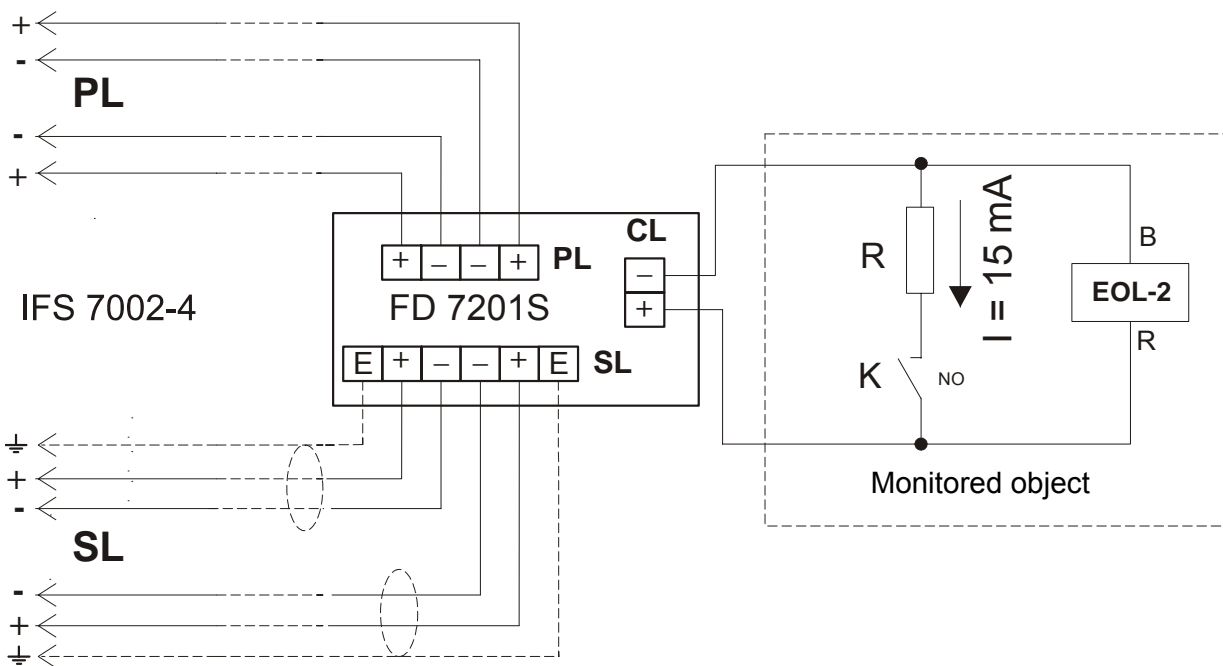

FD7201S connected to monitored input

The resistor value is determined according to the line voltage in which it is included, using the law of Ohms:

$$R = \frac{U}{I}$$

If the voltage is within the range of (12 – 24)V then the resistor is chosen to be within the range of (820Ω - 1,6 kΩ)

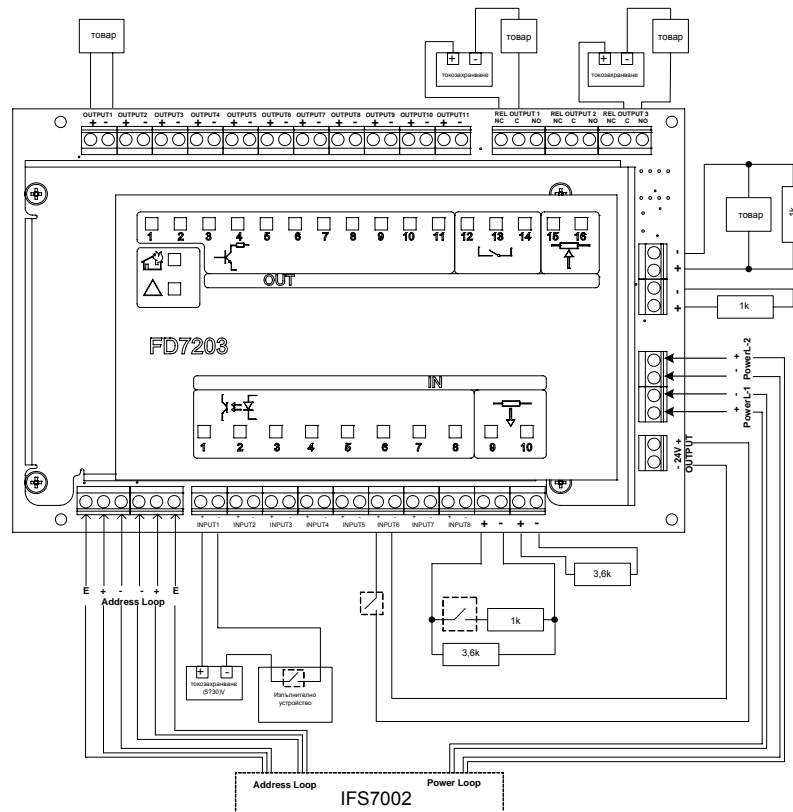

Input-output device FD7203 (10 inputs/16 output)  
Cable Connection to panel IFS7002 four signal loops

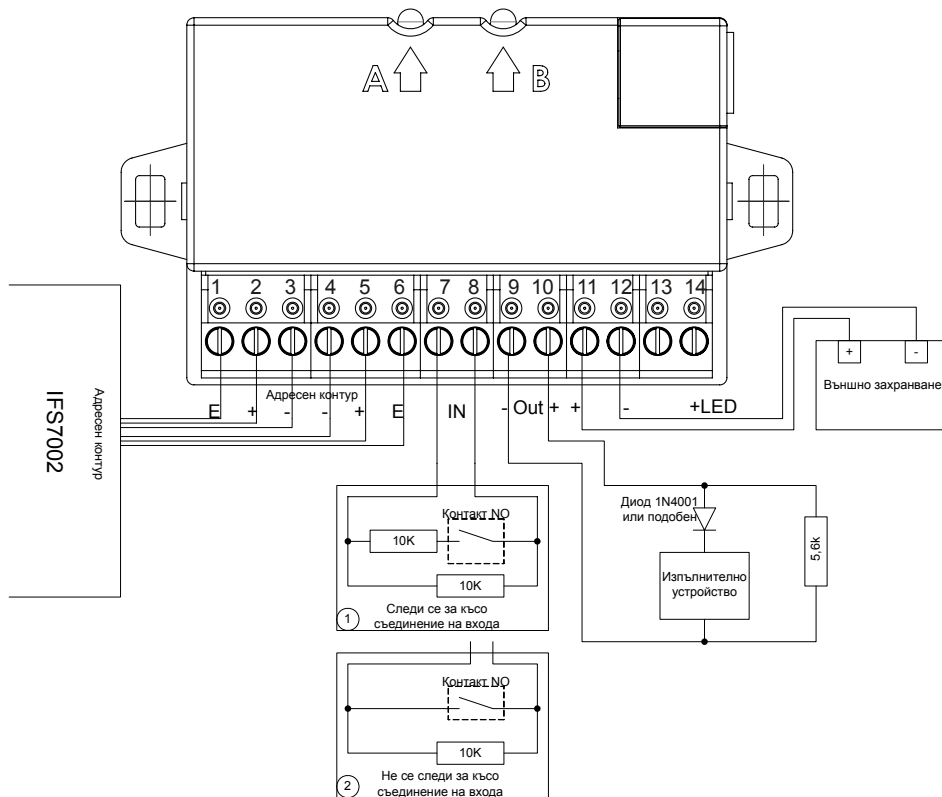

Input-output device FD7203 (1 input/1 output-monitoring)  
Cable Connection to panel IFS7002 four signal loops

Interactive Fire Control Panel FS7002 four signal loops – Operation in Local Network

1. Setting up of the CAN network

CAN – Controlled Area Network – is a serial communication protocol intended for steady and reliable data exchange and real-time control of hardware devices associated in a network. It has been developed to expand the communication capability between the devices by allowing a high-speed data exchange at lower realization price in the devices. The maximum data transmission rate is up to 11 Mbit/s. In the table below are given the parameters of the CAN channel depending on the distance and on the bit rate:

Max. Distance	Bit Rate	Type
10 m	1.6Mbit/s	High-speed
40 m	1.0Mbit/s	
130 m	500kbit/s	
270 m	250kbit/s	
530 m	125kbit/s	
620 m	100kbit/s	Low-speed
1300 m	50kbit/s	
3300 m	20kbit/s	
6700 m	10kbit/s	
10 000 m	5kbit/s	

The maximum distance between two devices shall be determined according to the data transmission rate.

In *High speed* mode of operation the line shall be terminated at both ends with 120 Ω characteristic impedance.

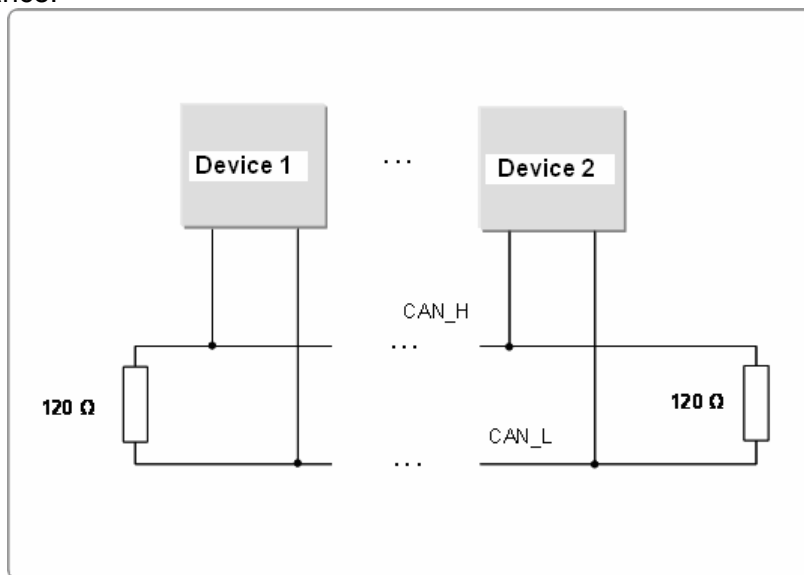
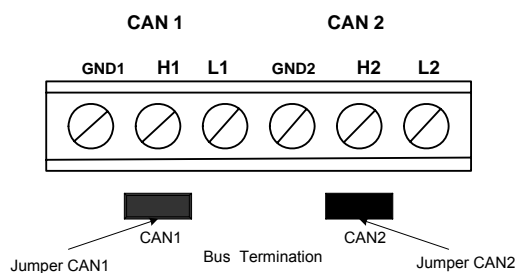

Fig.1

In IFS7002 the fire alarm line termination is done by the appropriate jumpers situated on the main board.

In IFS7002 with four signal loops, the line termination is done by the relevant jumpers, situated on the main board.



IFS7002 can support two CAN interfaces. Need for more interfaces appeared due to the requirements for development of complex topologies and networks of fire control panels. The CAN interface allows design of branched networks, which facilitates development of fire alarm systems in accordance with site specifications. At the same time it provides option for logical association of devices having various CAN interfaces. It is specifically useful in cases with remote control and configuration of remote fire control panels.

Configuring the network of Control Panels (and Remote Control Panels) includes the following activities:

- Defining levels of communication of the included in the network Control Panels – according to the specific project;
- Configuring of the Control Panel, defined as “Master”;
- Configuring each one of the associated “Slave” objects;

Note: The Appendix herein concerns only questions about the operation of Control Panels IFS7002 – four signal loops, connected in a local network.

## 2. Configuring the “Master” Control Panel (from which the Remote Control Panels will be monitored and managed).

Control panel configuration is performed as follows:

2.1. The Control Panel is in Duty MODE.

2.2. Button  (menu) activates menu of the Control Panel.

2.3. Select menu „Set Up”

2.4. By the digit buttons, enter password for access level.

2.5. Select menu “Panel

Configuration”, the following screen appears:

In order to be accessible of CAN interface from the next menu select Local Network – **ON**.

For alternative change press button

 (change).

(The default setting of this parameter is ON ,i.e passing through this item of setting is not necessary.)

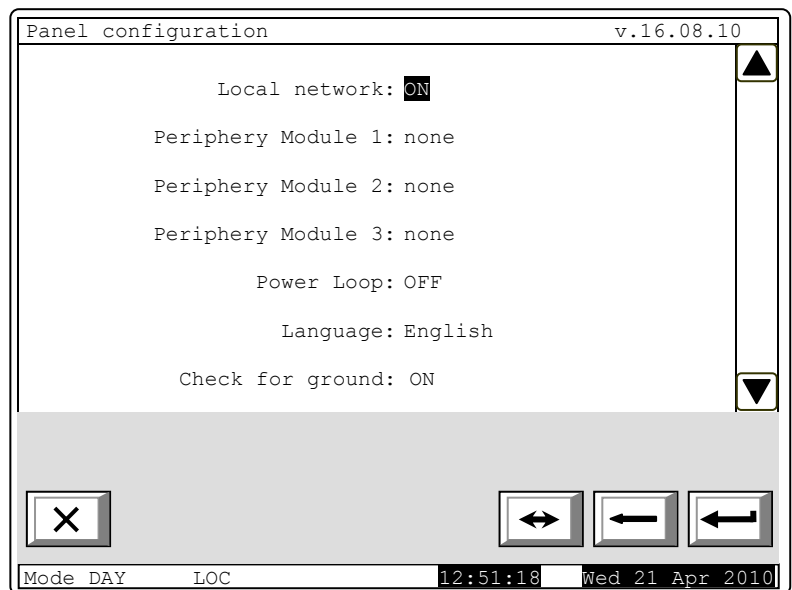

2.6. After connecting CAN interface, proceed to set the parameters of the CAN network in menu „Parameters of the Control Panel / Local Network“.

The submenu includes three items:

- CAN Local panel name;
- CAN Local parameters;
- CAN Remote object.

2.6.1. “CAN Local panel name“ In CAN Local panel name select the option for assigning a name to the local object. The name of the local object is a randomly composed string and may contain letters and figures (up to 20).

After reverting to the main menu you may continue the configuration of the local parameters. The screen displays the name of the local Control Panel (in the initial start up of the Control Panel, that name is factory set.)

Insert the name of the object (*for example Administration B*).The value of the parameter in “CAN name of a Local object” in the default setting is ”LOCAL”, i.e local (“Master”) Control panel is the main board.

**Note:** For better illustration further in the text are used examples of setting the Control Panels from the local network from Figure 2.

Then return to the main menu and continue configuring the local parameters.

2.6.2. In „CAN Local Parameters” enter the parameters of the connection.

The first line in the screen displays the inserted name of the object from the previous item (*for example : Administration B*)

The screen allows for setting the parameters related with the specific object (address on the network, priority communication level etc.)

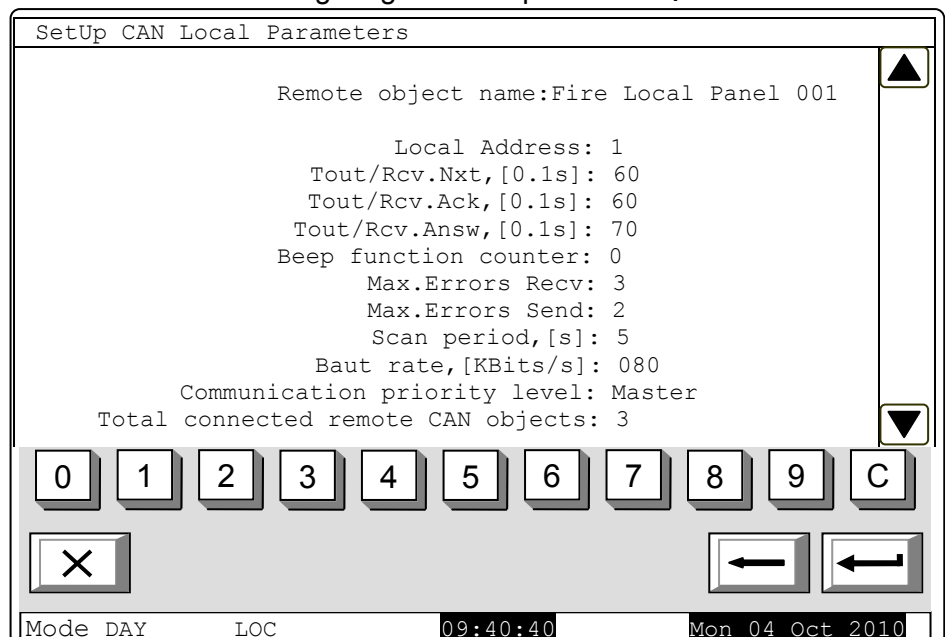
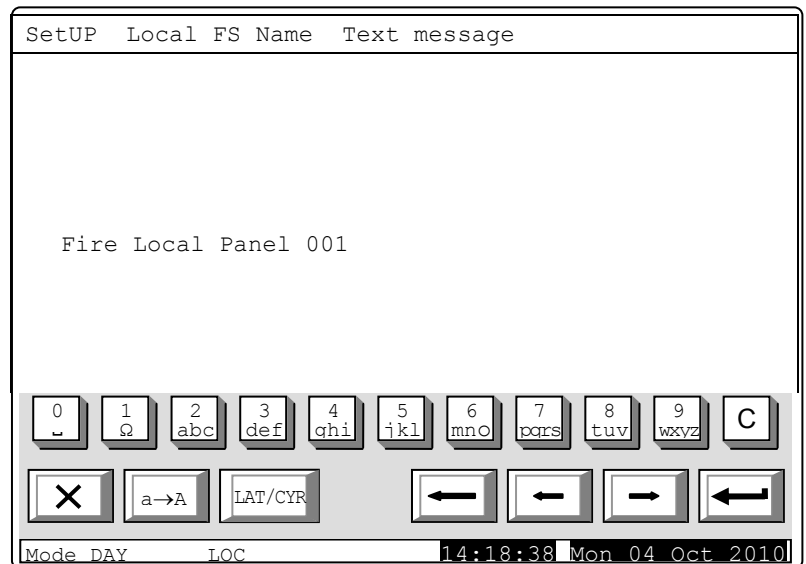

- Local Address: - from 0 to 127; (By-default, in delivery, main board is with address 1, and board loops is with address 101);
- Tout/Rcv Nxt,[0.1s]: – maximum awaiting time for receiving the next part of a telegram (a long message). Default value – 15\*0.1s = 1.5s. Possible range – 1 to 120;
- Tout/Rcv Ack,[0.1s]: – maximum awaiting time for receiving confirmation after a telegram – command/message is being sent, which does not require responds. Default value - 20\*0.1s = 2.0s. Possible range – 1 to 120;
- Tout/Rcv answ,[0.1s]: – maximum awaiting time for receiving respond to a sent telegram, which requires respond. Default value – 20\*0.1s = 2.0s. Possible range – 1 to 120;

- Beep function counter. At assigned value 0 no beep is produced – a short sound from the beeper meaning a successful check on the local control panel's connection with the consequent remote control panel. At value  $N > 0$  the beeper will release signal upon each successful N-check. For example, if  $N = 1$ , each check, performed during each *Check period*, [s] will be signaled. Default value – 0. Possible range – 0 to 100.
- Max. Errors Recv: – number of CAN communication errors upon receiving telegrams from remote control panels; after this number is reached the respective control panel is considered as “dropped out” (temporarily) from the CAN, and fault condition is signaled – failure in connection with remote control panel, address...Default value – 3. Possible range – 1 to 20.
- Max. Errors Send: – number of CAN communication errors upon sending telegrams to remote control panels; after this number is reached, the respective control panel is considered as “dropped out” (temporarily) from the CAN, and fault condition is signaled – failure in connection with remote control panel, address...Default value – 3. Possible range – 1 to 20.
- Scan period, [s]: – a time interval is set and after it is expired, the local control panel will run a check (scan) the state of the CAN communication with the connected remote control panels, including the dropped out panels. Default value – 10 s. Possible range – 1 to 250 s.
- Baud rate, [KBits/s]: Possible values - 640, 320, 213, 160, 128, 106, 91, 80, 71, 64, 58, 53, 49, 45, 42, 40, 35, 32, 29, 26, 24, 22, 21, 20, 17, 16, 14, 13, 11, 10 [KBits/s];
- Communication priority level: – the position of the control panel in setup condition, in the constructed CAN is defined here. Possible values – *Master* and *Slave*. One of the control panels participating in the IFS 7000 CAN shall be defined as *Master*, and all other control panels in the network shall be defined as *Slave*. The master control panel shall be connected to the rest of the control panels in the network – directly or via repeater.

Connection of many objects (fire control panels for example) into a network calls for identification among them. That's why they shall have a unique sign. Typically, in a network it has to be a number. The number is formed through de-coding of a few parameters – name and address. The object's name is usually needed by the “human interface” – the user shall easily recognize the devices connected into the network. The next compulsory parameter is the address. It is the actual parameter used by the software for data exchange along the network. Upon configuration each device shall obtain a name and an address. In the IFS 7000 series the devices share a common address area. The maximum number of UniPOS fire control panels connected to a CAN is 16. The name is important to the user only and an object with a local name, when added to the list of local objects, may receive another name, suitable according to the user.

After the local network parameters are configured, it is necessary to select which objects will the local object operate with, and which desired options will be configured by the user upon data exchange. For the purpose use the menu for adding and object. To use the option, other devices shall have been previously physically connected to other devices in the CAN. For their proper functioning and exchange the devices shall have their local parameters previously configured.

*Example:*

*Network of three stations IFS7002-four loops, where the Control Panel, located in the administration must monitor and manage the Control Panels in buildings one and two. The three stations are connected by CAN 1.*

*As Master Control Panel (Master) is set Administration B station (main board) - CAN address 1. As slave are set Administration L (board loops) and the Control Panels in Buildings 1 and 2. The slave Control Panels Building 1 and Building 2 are with changed CAN addresses. (Each object must have a unique network address in order to be distinguished).*

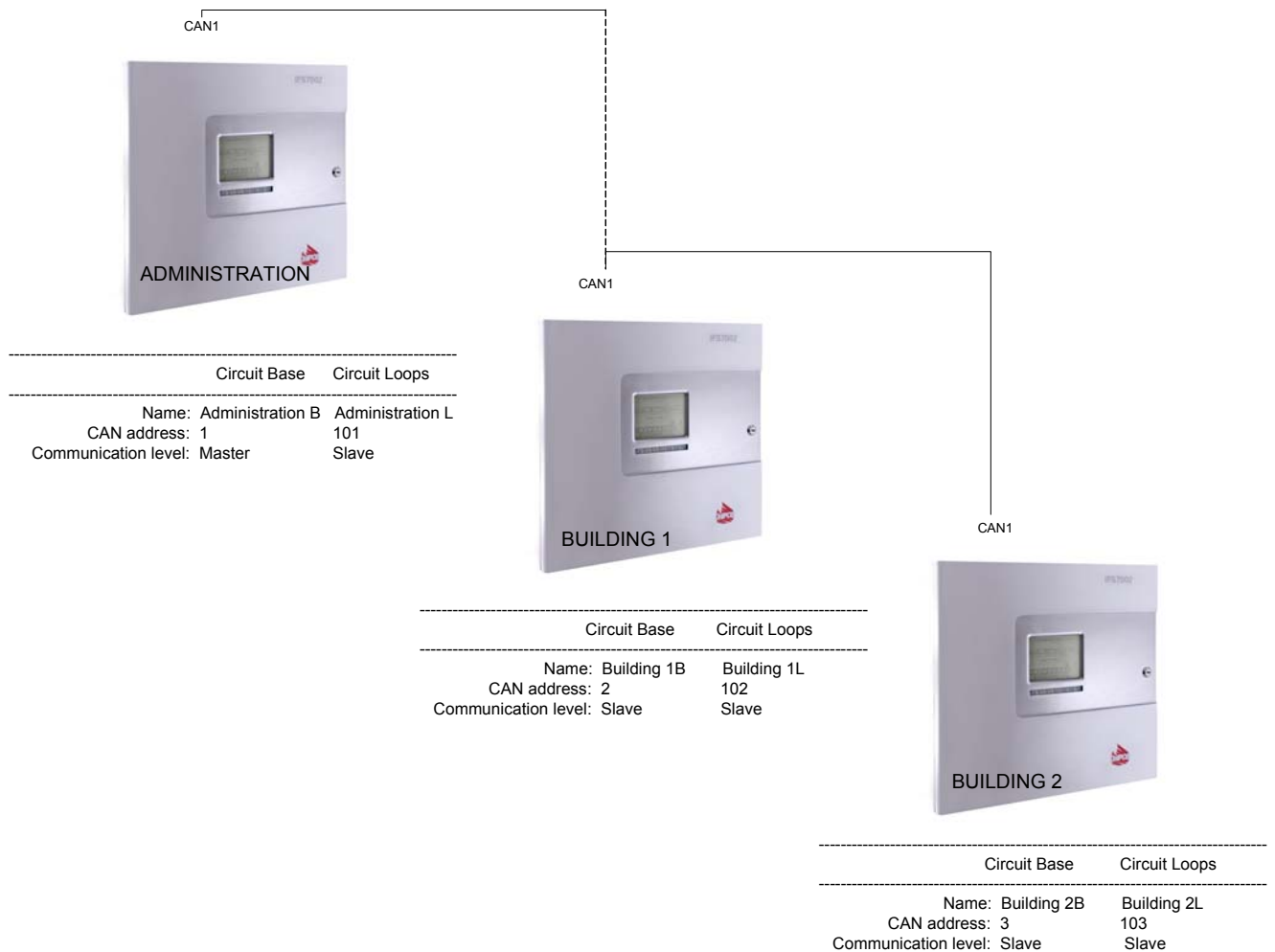

Fig.2

The next step is adding CAN object, by which the local Control Panel will exchange data and perform monitoring. In this menu describe all the connected objects to the Control Panel which is to be set. (For example: Administration L, Building 1B, Building 1L, Building 2B, Building 2L).

2.6.3. The menu is used to describe the objects to which the Control Panel will exchange data.

Menu includes:

- View/Edit CAN object;
- Add new CAN object;
- Remove CAN object.

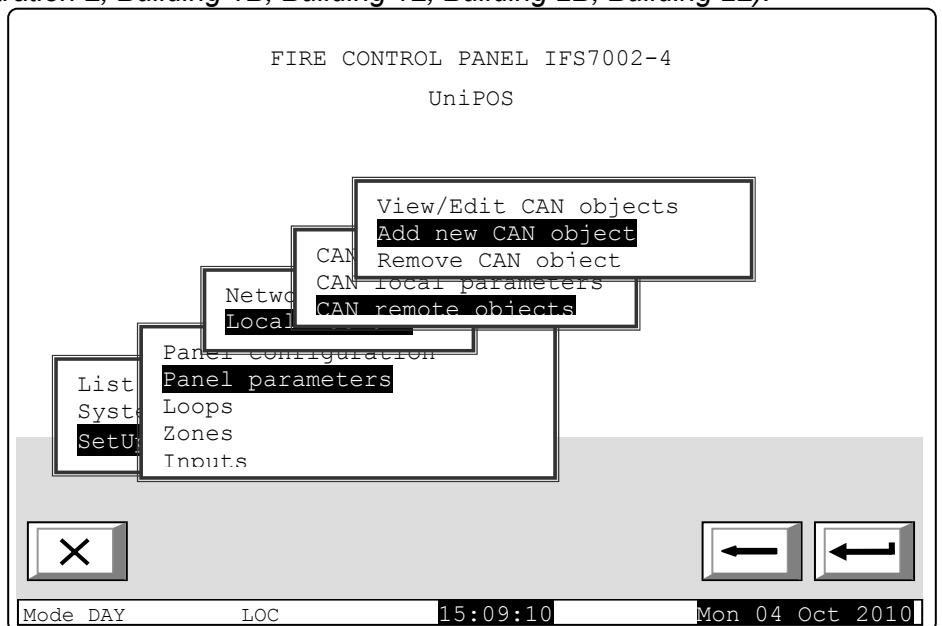



2.6.3.1. Adding CAN object includes steps for describing the added object:

- Enter object name;
- Parameters of the object;
- Communication of the object with other remote objects.

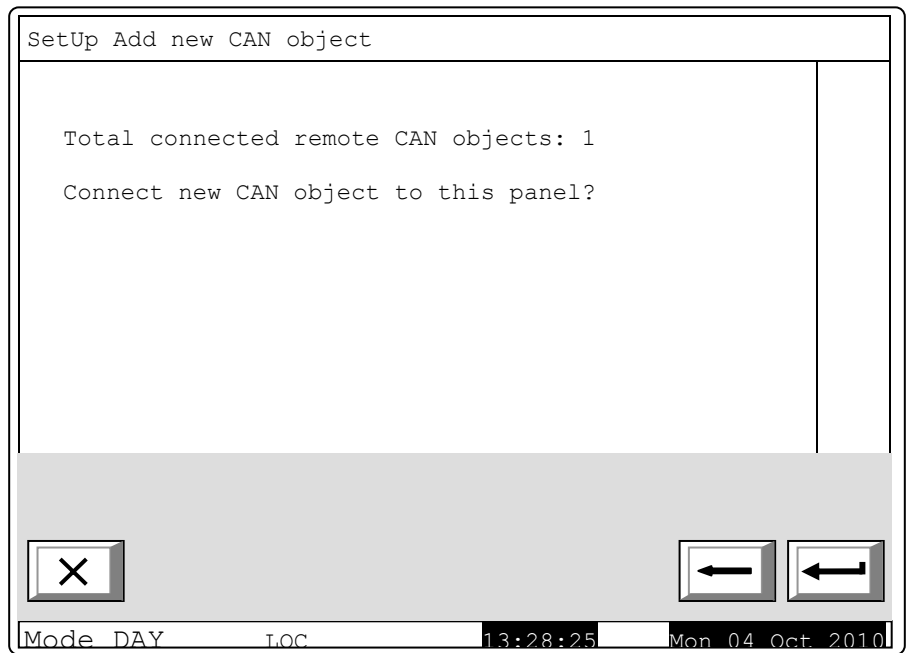

If there are no currently added new CAN objects, then to the Master Control Panel (Administration B) is connected only one factory set and defined object – Administration L.

• A name of the remote object can be assigned using the menu displayed above. The name is a random one (up to 20 symbols) and is not mandatory the same name given in the local parameters of the remote object.

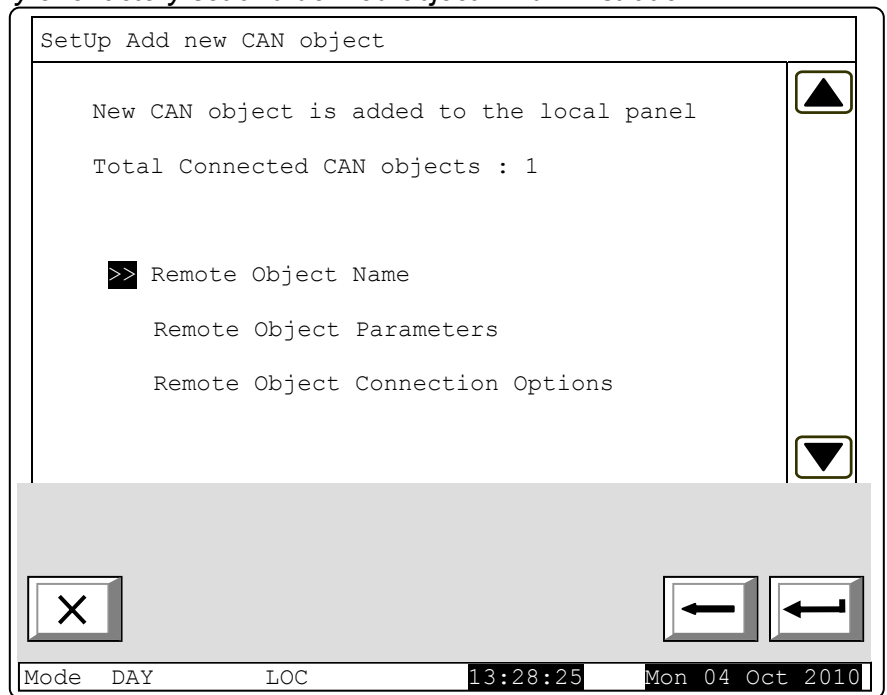

Be advised, that by entering menu, you actually add automatically the last object to the list of connected objects. Therefore, the menu shall be accessed only when you add a new object.

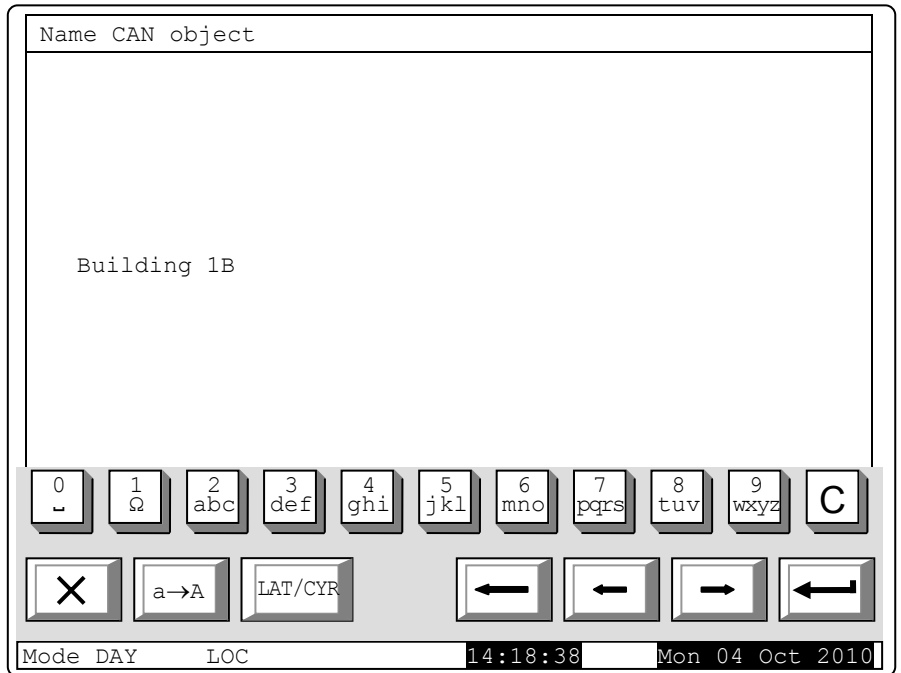

Add name of the remote object on the screen. The name must be random (up to 20 characters) and it is not necessary to be the same as the one specified in the local parameters of the remote object.

*For Example: To add objects with names „Building 1B”, „Building 1L”, „Building 2B” and „Building 2L” is necessary to add consecutively the names from the menu „Name CAN object”.*

- „Building 1B” – for board main in Building 1;
- „Building 1L” – for board loops in Building 1
- „Building 2B” – for main board in Building 2;
- „Building 2L” – for board loops Building 2.

• After a name has been given to the connected object, go back to the main menu and select the option for parameter adjustment of the newly added object:

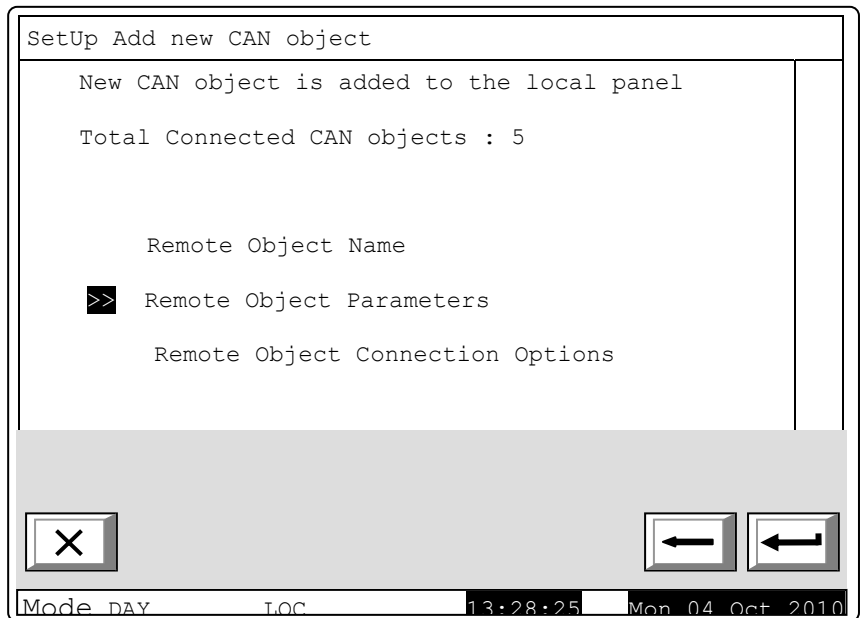

In this menu corrections can be made to an existing CAN object. The field *Communication Priority Level* defines the position of the described remote object (fire control panel) in the network – *Master* or *Slave*. The field *CAN Communication port* defines the port where the object is connected to. The connection type defines the means of the connection. In case of direct connection, the objects are assigned to one and the same CAN, in the address field of the repeater the default value is 0. In case of connection of CAN 1 and CAN2 objects, the address of

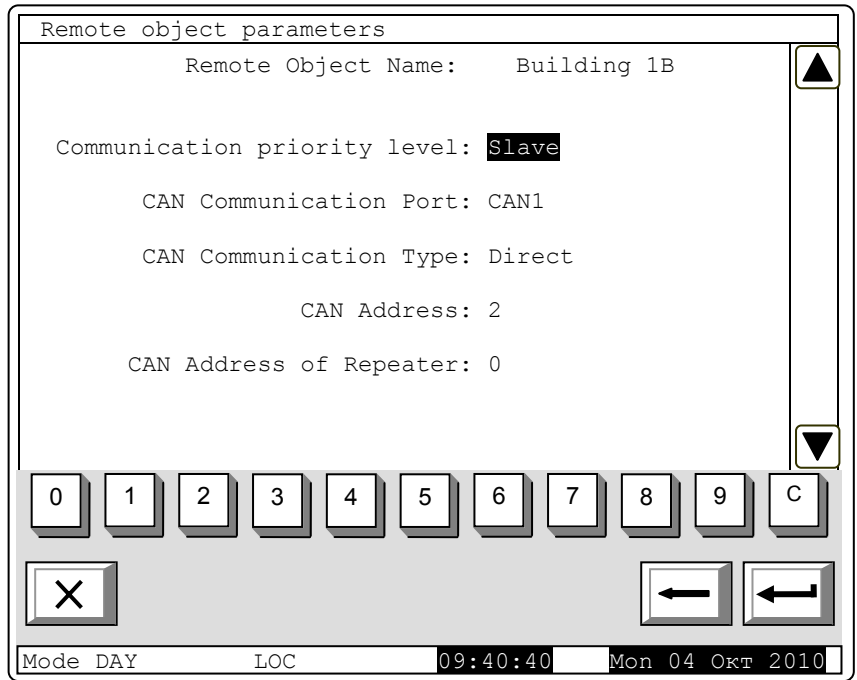

the relevant control panel shall be defined. Also, the connection type shall be changed, in **CAN Communication port: Via repeater**. Repeater’s address shall be set too – as a CAN address of an object –repeater. The repeater object shall be described as an object assigned to the CAN, to the local control panel.

To use the control panel as a repeater, it shall be configured for a connection with the control panels that will use it as a repeater.

The procedure for describing parameters of the connected objects (Control Panels) in the "Master" Control Panel is the same for each included object on the network.

*For Example: In designated as "Master" Control Panel (Administration B) should be described the parameters separately for each connected object (Administration L, Building 1B, Building 1L, Building 2B and Building 2L ). Settings defined in the "Master" Control Panel (Administration B) are as follows:*

Remote Object Name	Com.priority level	CAN port	CAN com. type	CAN address	CAN address of repeater
Administration L	Slave	CAN 1	Direct	101	0
Building 1 B	Slave	CAN 1	Direct	2	0
Building 1 L	Slave	CAN 1	Direct	102	0
Building 2 B	Slave	CAN 1	Direct	3	0
Building 2 L	Slave	CAN 1	Direct	103	0

• Adding communication options to the object:  
Communication options include defining of the data which the Remote Panel will exchange in sections:

- Fires and Faults;
- Lists & Archives;
- Set Up Systems.

The menu offers a choice of setting the functionality of the Fire Control Panel and setting the data, exchanged by the Panels connected in a network.

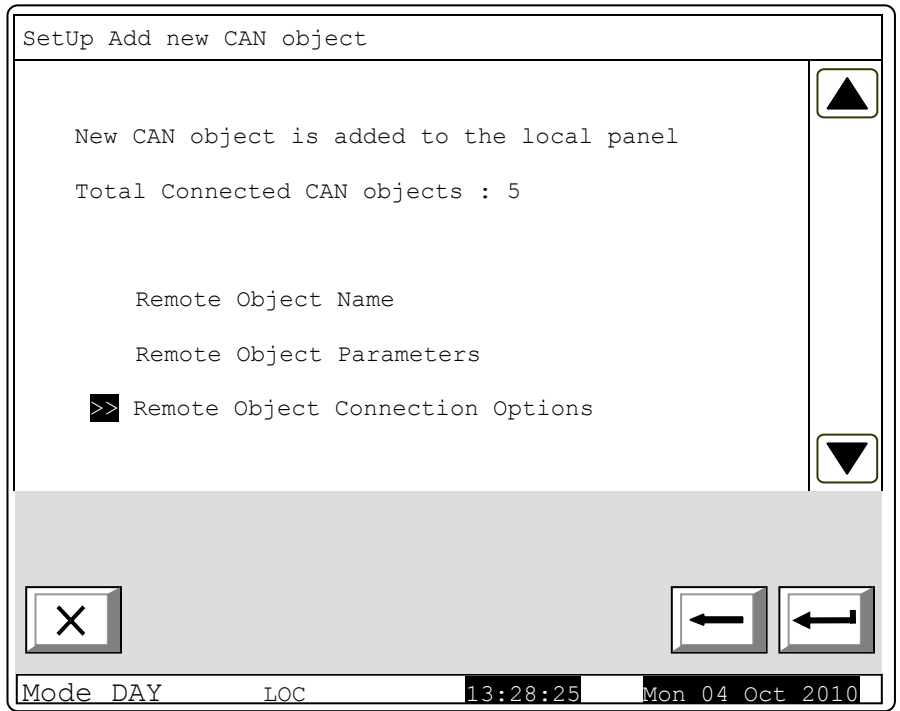

*Example:* To the Control Panel Administration B, defined as a master, are listed five connected objects with their names, CAN addresses and communication levels. Perform the setting of each CAN object separately in the menu "Communication. Options CAN object "described below.

- Screen „Fires, Faults”

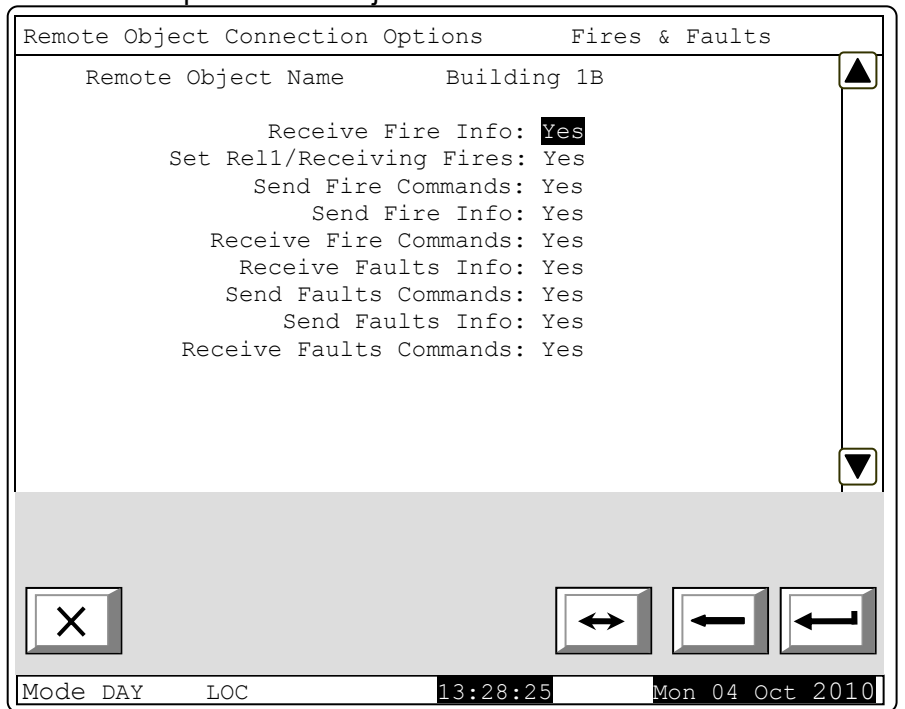

- Screen “Lists, Archives”

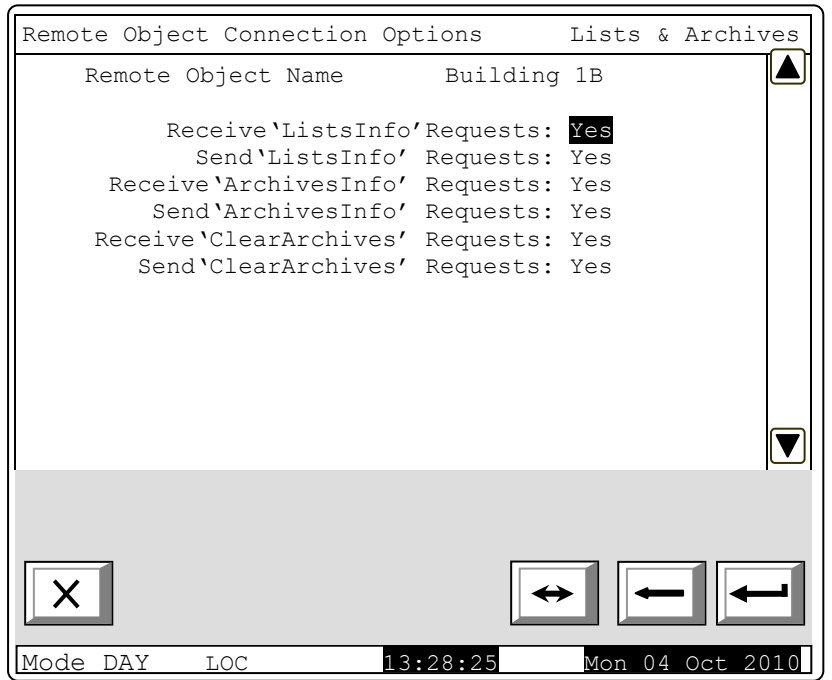

- Screen „Setup, Systems”

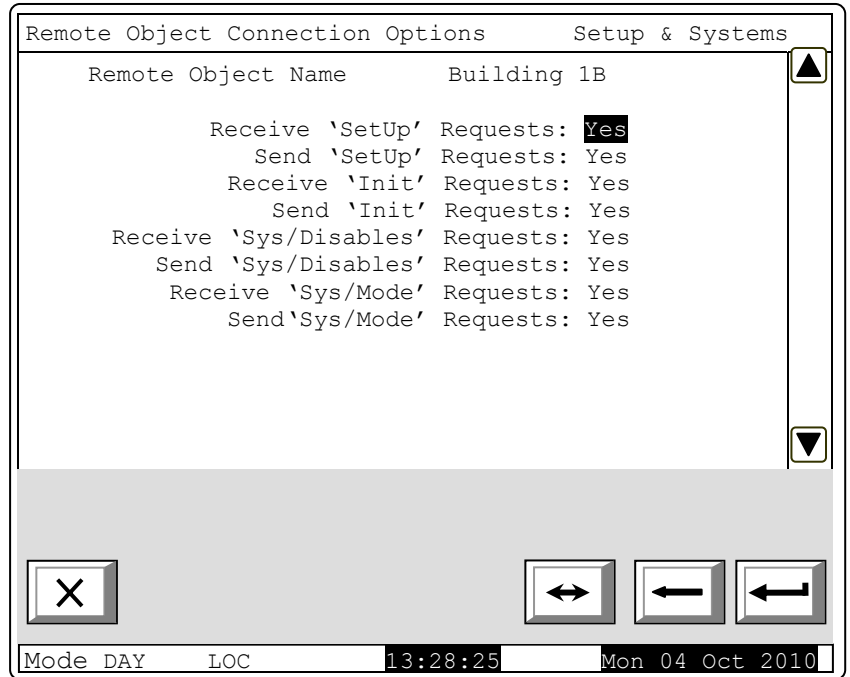

2.6.3.2. Menu "Remove CAN object"

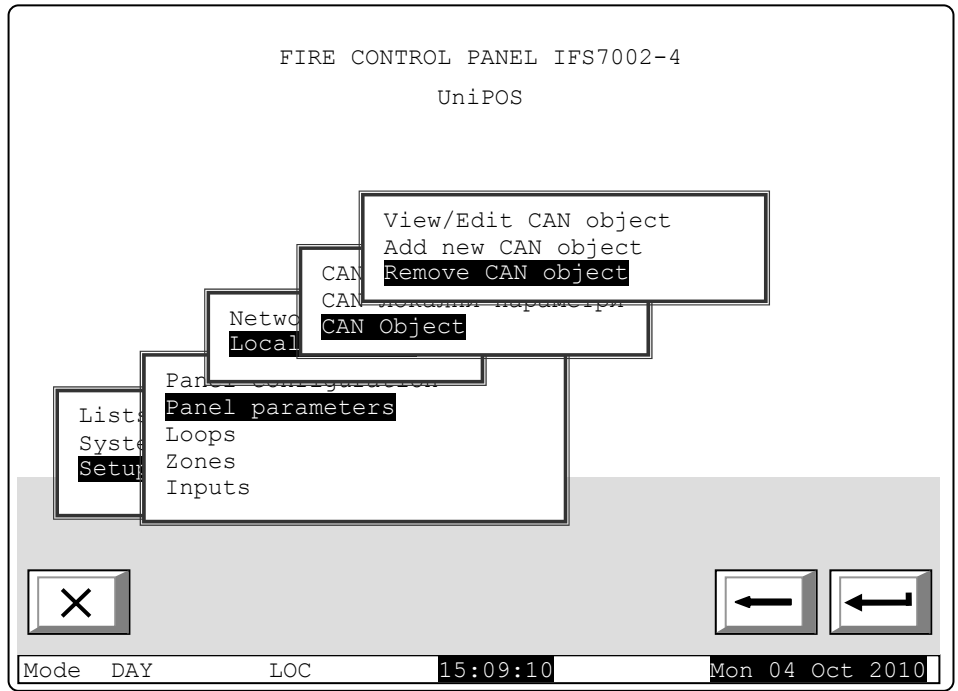

Menu is used to terminate the communication with the object of the local network.

Select Menu „Set Up/Control Panel Parameters /Local Network /CAN Objects/Remove CAN object“.

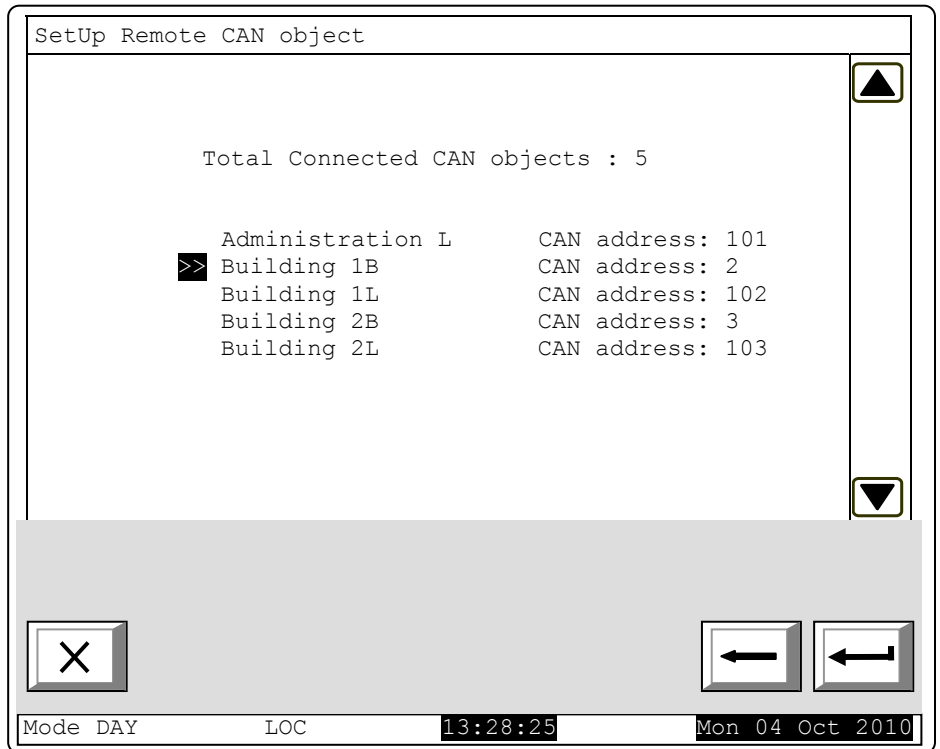

The Screen shows the total number of the connected objects and their list. In the list, each object is identified by name and CAN address.



Use buttons  and  on the right side of the panel to move the cursor to the location of the object for removal and press  to remove the object.

After deleting the selected object, the total number of connected objects is automatically reduced by one.

2.6.3.3. Review entered CAN object.

The function is used to view and / or change the parameters of a connected object from the local network.

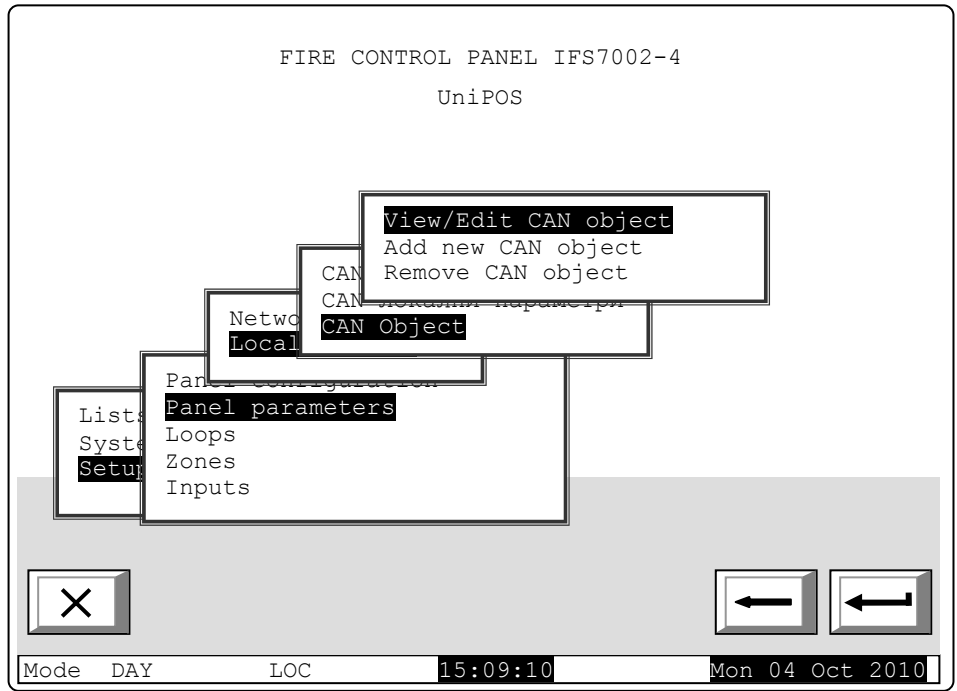

Choosing the option above allows for reviewing and adjustments going through the menus similar to those described above. Example: The screen shown contains information for three connected objects. By scrolling choose which object to be reconfigured.

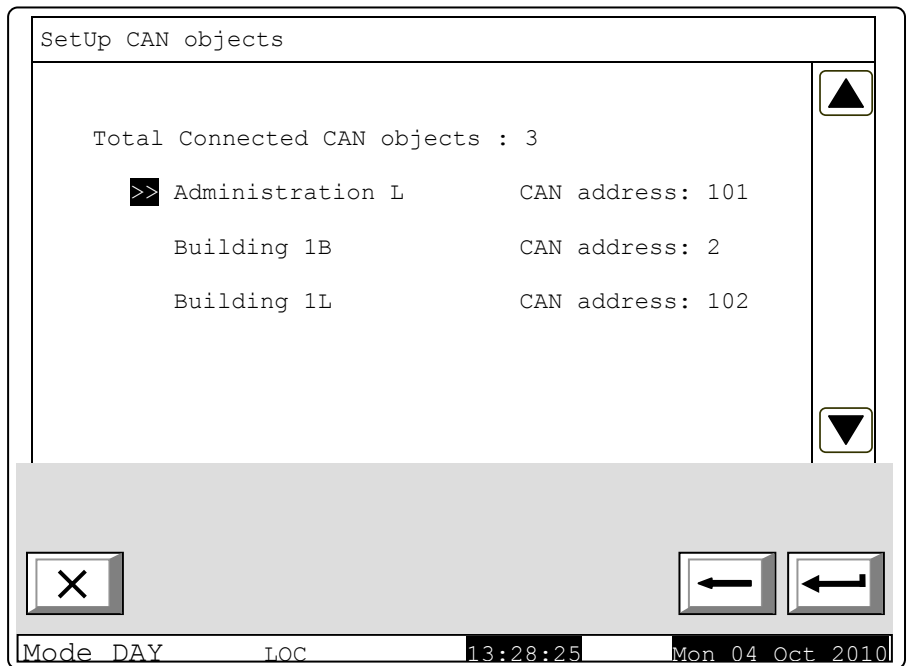

3. Configuring the "Slave" Control Panel

Control panel configuration is performed as follows:

3.1. The Control Panel is in Duty MODE.

3.2. Button  (menu) activates menu of the Control Panel.

3.3. Select menu „Set Up”

3.4. By the digit buttons, enter password for access level.

3.5. Select menu “Panel Configuration”, the following screen appears:

In order to be accessible of CAN interface from the next menu select Local Network – **ON**.

For alternative change press button



(change).

(The default setting of this parameter is ON ,i.e passing through this item of setting is not necessary.)

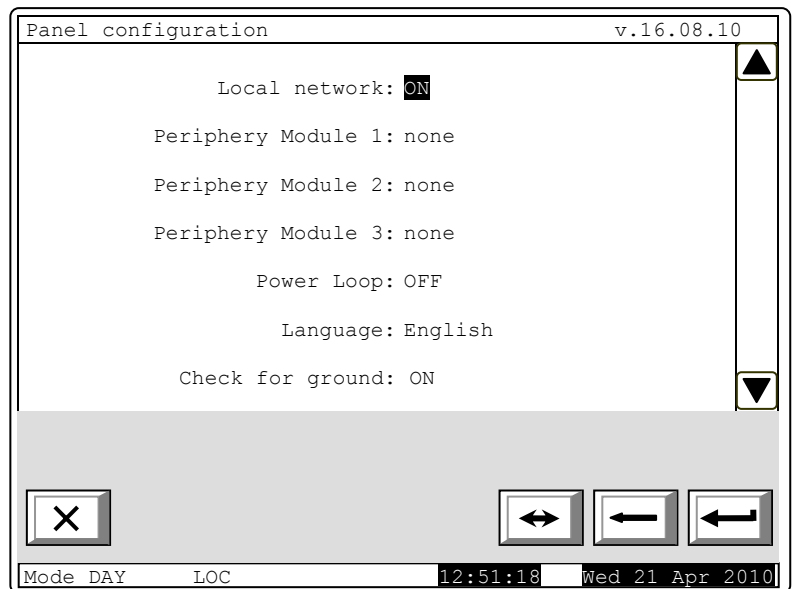

3.6. After connecting CAN interface,

proceed to set the parameters of the CAN network in menu „Parameters of the Control Panel / Local Network”.

The submenu includes three items:

- CAN Local panel name;
- CAN Local parameters;
- CAN Remote object.

3.6.1. “CAN Local panel name” In CAN Local panel name select the option for assigning a name to the local object. The name of the local object is a randomly composed string and may contain letters and figures (up to 20). After reverting to the main menu you may continue the configuration of the local parameters.

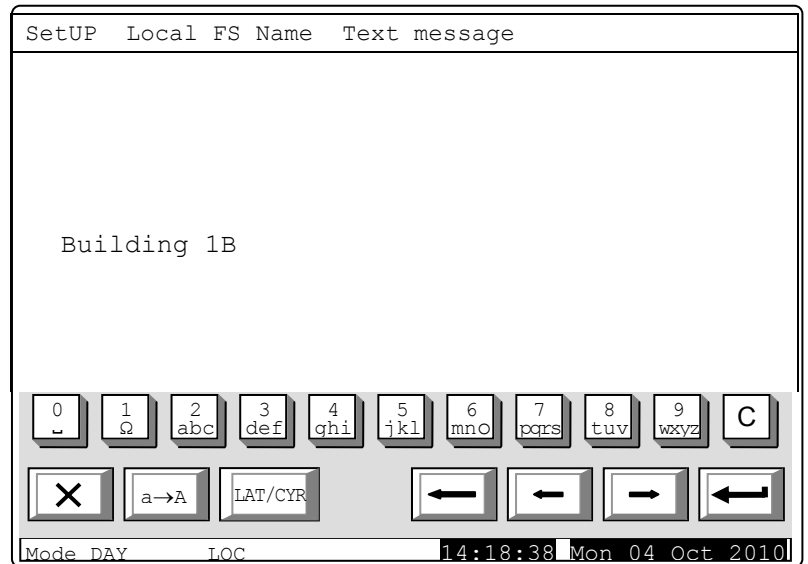

The screen displays the name of the local Control Panel  
Insert the name of the object (*for example Building 1B*).

**Note:** For better illustration further in the text are used examples of setting the Control Panels from the local network from Figure 2.

Then return to the main menu and continue configuring the local parameters.



3.6.2. In „CAN Local Parameters” enter the parameters of the connection.

The first line in the screen displays the inserted name of the object from the previous item (for example : *Building 1B*)

The screen allows for setting the parameters related with the specific object (address on the network, priority communication level etc.)

- Local Address: - from 0 to 127;
- Tout/Rcv Nxt,[0.1s]: – maximum awaiting time for receiving the next part of a telegram (a long message). Default value –  $15 \cdot 0.1s = 1.5s$ . Possible range – 1 to 120;
- Tout/Rcv Ack,[0.1s]: – maximum awaiting time for receiving confirmation after a telegram – command/message is being sent, which does not require responds. Default value -  $20 \cdot 0.1s = 2.0s$ . Possible range – 1 to 120;
- Tout/Rcv answ,[0.1s]: – maximum awaiting time for receiving respond to a sent telegram, which requires respond. Default value –  $20 \cdot 0.1s = 2.0s$ . Possible range – 1 to 120;
- Beep function counter. At assigned value 0 no beep is produces – a short sound from the beeper meaning a successful check on the local control panel’s connection with the consequent remote control panel. At value  $N > 0$  the beeper will release signal upon each successful N-check. For example, if  $N = 1$ , each check, performed during each *Check period, [s]* will be signaled. Default value – 0. Possible range – 0 to 100.
- Max. Errors Recv: – number of CAN communication errors upon receiving telegrams fro remote control panels; after this number is reached the respective control panel is considered as “dropped out” (temporarily) from the CAN, and fault condition is signaled – failure in connection with remote control panel, address...Default value – 3. Possible range – 1 to 20.
- Max. Errors Send: – number of CAN communication errors upon sending telegrams to remote control panels; after this number is reached, the respective control panel is considered as “dropped out” (temporarily) from the CAN, and fault condition is signaled – failure in connection with remote control panel, address...Default value – 3. Possible range – 1 to 20.
- Scan period, [s]: – a time interval is set and after it is expired, the local control panel will run a check (scan) the state of the CAN communication with the connected remote control panels, including the dropped out panels. Default value – 10 s. Possible range – 1 to 250 s.
- Baud rate, [KBits/s]: Possible values - 640, 320, 213, 160, 128, 106, 91, 80, 71, 64, 58, 53, 49, 45, 42, 40, 35, 32, 29, 26, 24, 22, 21,20, 17, 16, 14, 13, 11, 10 [KBits/s];
- Communication priority level: – the position of the control panel in setup condition, in the constructed CAN is defined here. Possible values – *Master* and *Slave*. One of the control panels participating in the IFS 7000 CAN shall be defined as *Master*, and all other control panels in the network shall be defined as *Slave*. The master control panel shall be connected to the rest of the control panels in the network – directly or via repeater.

Connection of many objects (fire control panels for example) into a network calls for identification among them. That’s why they shall have a unique sign. Typically, in a network it has to be a number. The number is formed through de-coding of a few parameters – name and address. The object’s name is usually needed by the “human interface” – the user shall easily recognize the devices connected into the network. The next compulsory parameter is the address. It is the actual parameter used by the software for data exchange along the network. Upon configuration each device shall obtain a name and an address. In the IFS 7000 series the devices share a common address area.

The maximum number of UniPOS fire control panels connected to a CAN is 16. The name is important to the user only and an object with a local name, when added to the list of local objects, may receive another name, suitable according to the user.

After the local network parameters are configured, it is necessary to select which objects will the local object operate with, and which desired options will be configured by the user upon data exchange. For the purpose use the menu for adding and object. To use the option, other devices shall have been previously physically connected to other devices in the CAN. For their proper functioning and exchange the devices shall have their local parameters previously configured.

*Example (fig.2):*

*Network of three stations IFS7002-four loops, where the Control Panel, located in the administration must monitor and manage the Control Panels in buildings one and two. The three stations are connected by CAN 1.*

*As Master Control Panel (Master) is set Administration B station (main board) - CAN address 1. As slave are set Administration L (board loops) and the Control Panels in Buildings 1 and 2. The slave Control Panels Building 1 and Building 2 are with changed CAN addresses. (Each object must have an unique network address in order to be distinguished).*

The next step is adding CAN object, by which the local Control Panel will exchange data and perform monitoring. In this menu describe all the connected objects to the Control Panel which is to be set. (For example: Administration L, Building 1B, Building 1L, Building 2B, Building 2L).

3.6.3. The menu is used to describe the objects to which the Control Panel will exchange data.

Menu includes:

- View/Edit CAN object;
- Add new CAN object;
- Remove CAN object.

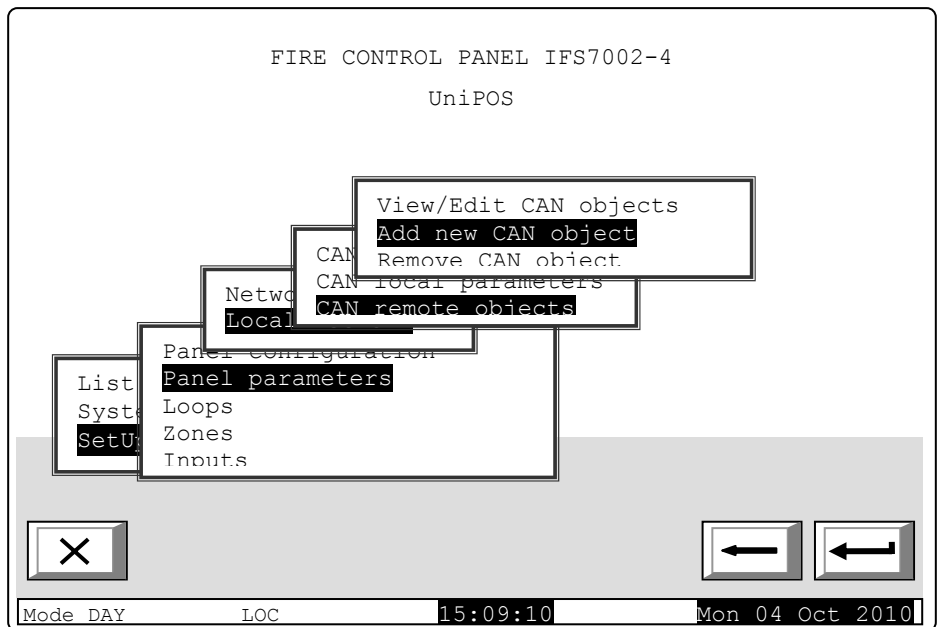

3.6.3.1. Adding CAN object includes steps for describing the added object:

- Enter object name;
- Parameters of the object;
- Communication of the object with other remote objects.

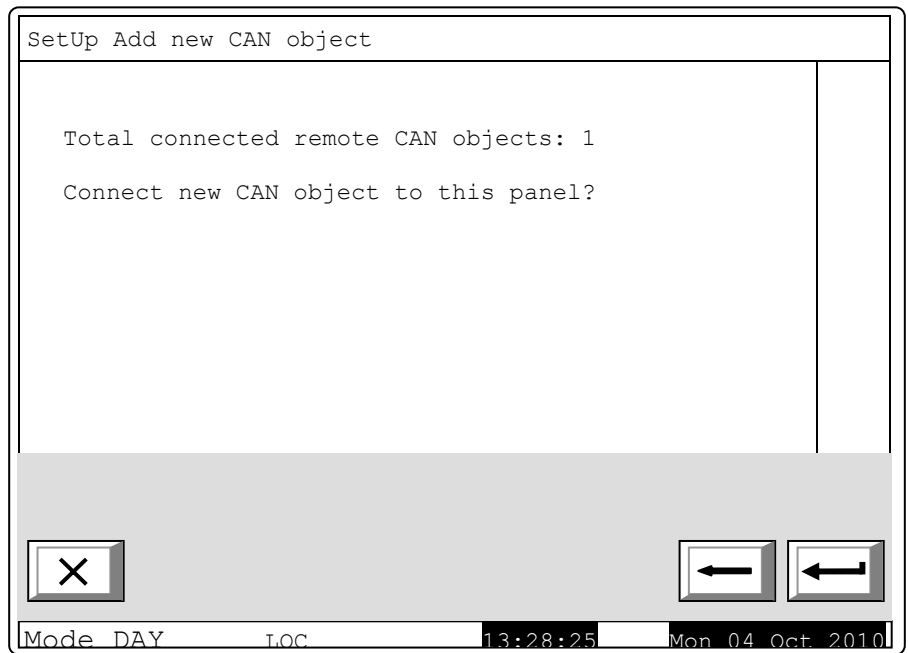

• A name of the remote object can be assigned using the menu displayed above. The name is a random one (up to 20 symbols) and is not mandatory the same name given in the local parameters of the remote object.

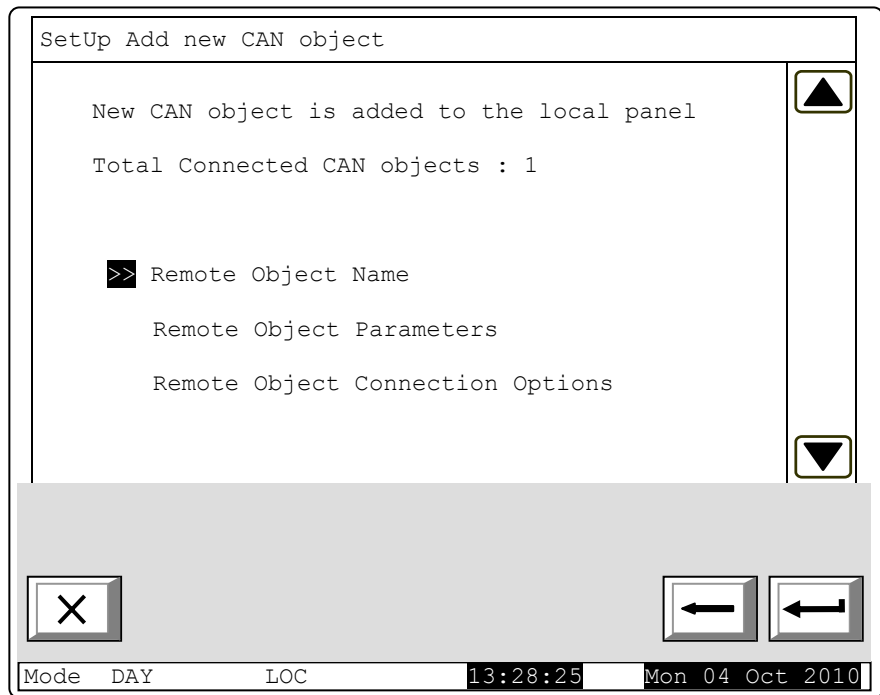

Be advised, that by entering menu, you actually add automatically the last object to the list of connected objects. Therefore, the menu shall be accessed only when you add a new object.

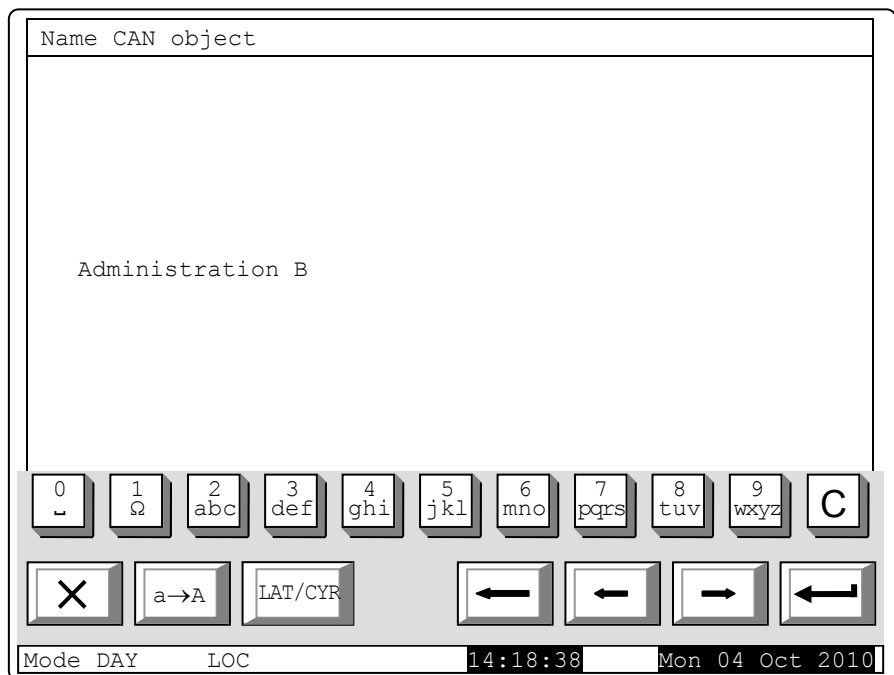

Add name of the remote object on the screen. The name must be random (up to 20 characters) and it is not necessary to be the same as the one specified in the local parameters of the remote object.

*For Example: To add objects with names „Administration B”, „Building 1L” and „Building 2B” is necessary to add consecutively the names from the menu „Name CAN object”.*

- „Administration B” – for board main in Building Administration (master);
- „Building 1L” – for board loops in Building 1(slave)
- „Building 2B” – for main board in Building 2 (slave);

• After a name has been given to the connected object, go back to the main menu and select the option for parameter adjustment of the newly added object:

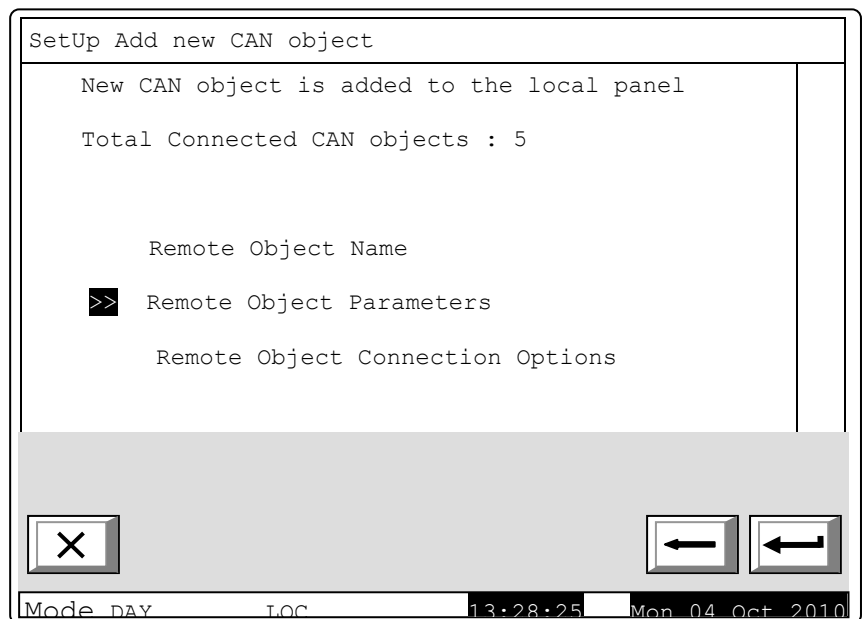

In this menu corrections can be made to an existing CAN object. The field *Communication Priority Level* defines the position of the described remote object (fire control panel) in the network – *Master* or *Slave*. The field *CAN Communication port* defines the port where the object is connected to. The connection type defines the means of the connection. In case of direct connection, the objects are assigned to one and the same CAN, in the address field of the repeater the default value is 0. In case of connection of CAN 1 and CAN2 objects, the address of

Remote object parameters

Remote Object Name: Administration B

Communication priority level: **Master**

CAN Communication Port: CAN1

CAN Communication Type: Direct

CAN Address: 1

CAN Address of Repeater: 0

0 1 2 3 4 5 6 7 8 9 C

X

Mode DAY LOC 09:40:40 Mon 04 Oct 2010

the relevant control panel shall be defined. Also, the connection type shall be changed, in **CAN Communication port: Via repeater**. Repeater's address shall be set too – as a CAN address of an object –repeater. The repeater object shall be described as an object assigned to the CAN, to the local control panel.

To use the control panel as a repeater, it shall be configured for a connection with the control panels that will use it as a repeater.

The procedure for describing parameters of the connected objects (Control Panels) in the "Master" Control Panel is the same for each included object on the network.

*For Example: In "Building 1B" should be described the parameters separately for each connected object (Administration B, Building 1L, Building 2B). Settings defined in the "Slave" Control Panel (Building 1B) are as follows:*

Remote Object Name	Com.priority level	CAN port	CAN com. type	CAN address	CAN address of repeater
Administration B	Master	CAN 1	Direct	1	0
Building 1 L	Slave	CAN 1	Direct	102	0
Building 2 B	Slave	CAN 1	Direct	3	0

• Adding communication options to the object:  
Communication options include defining of the data which the Remote Panel will exchange in sections:

- Fires and Faults;
- Lists & Archives;
- Set Up Systems.

The menu offers a choice of setting the functionality of the Fire Control Panel and setting the data, exchanged by the Panels connected in a network.

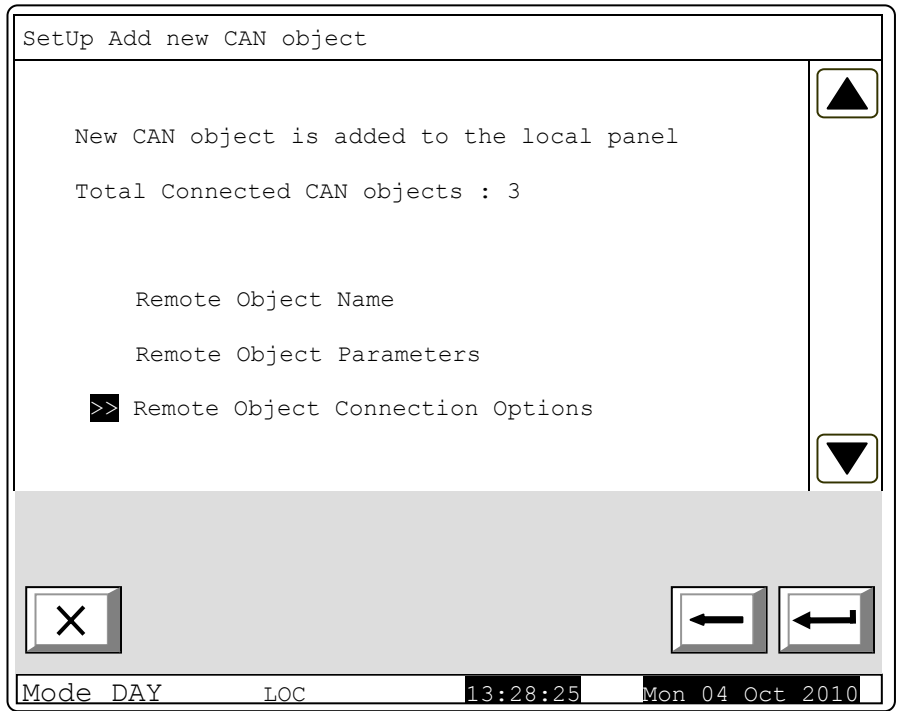

*Example: To the Control Panel Building 1B, defined as a slave, are listed five connected objects with their names, CAN addresses and communication levels. Perform the setting of each CAN object separately in the menu "Communication. Options CAN object "described below.*

- Screen „Fires, Faults”

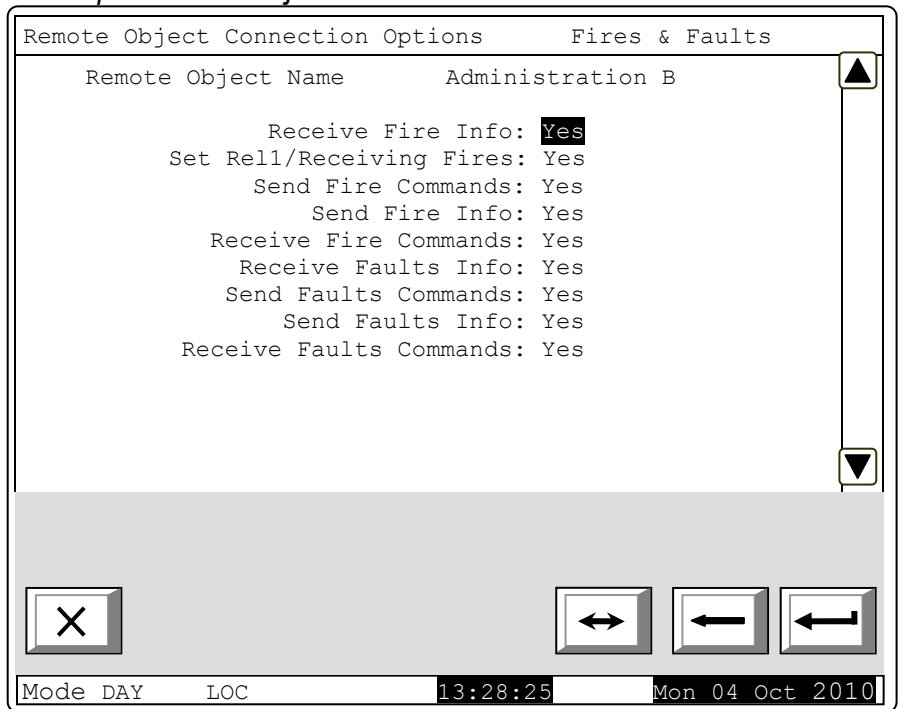

- Screen “Lists, Archives”

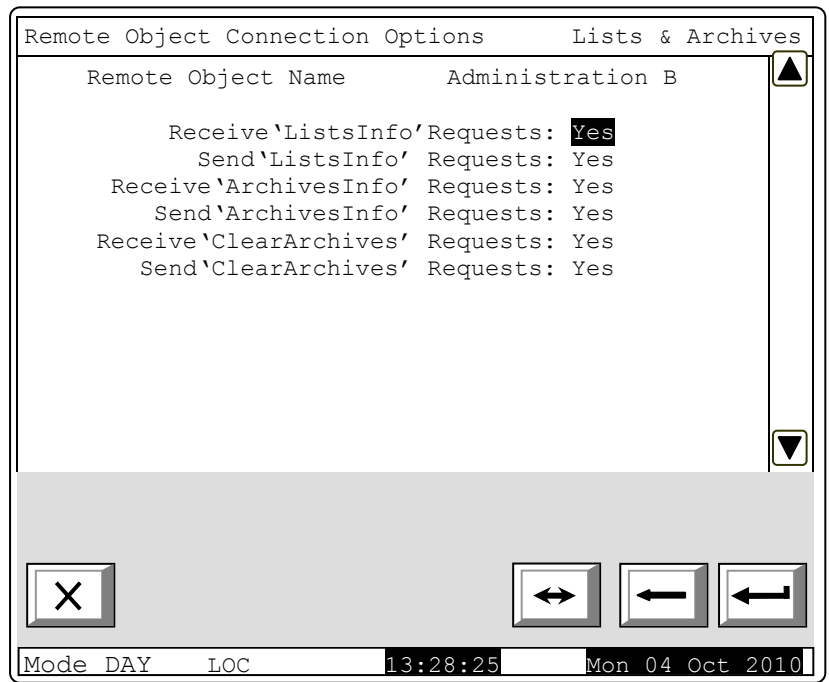

- Screen „Setup, Systems”

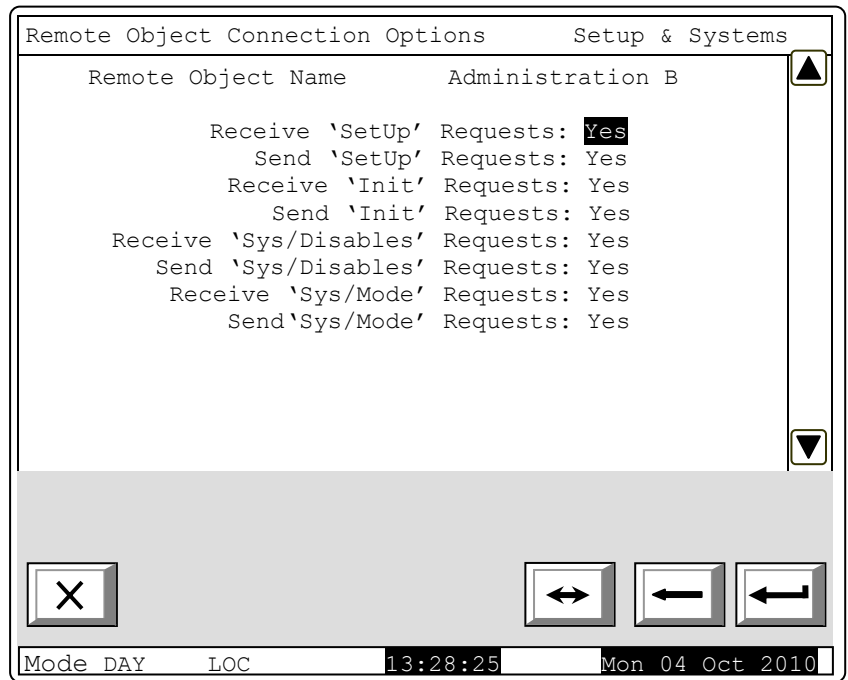

3.6.3.2. Menu "Remove CAN object"

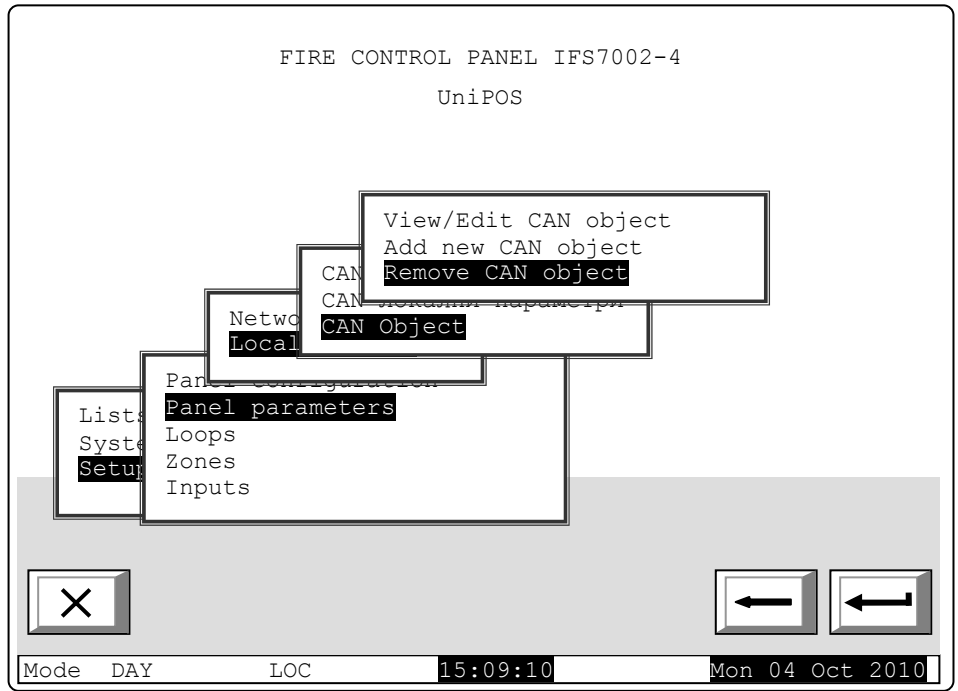

Menu is used to terminate the communication with the object of the local network.

Select Menu „Set Up/Control Panel Parameters /Local Network /CAN Objects/Remove CAN object“.

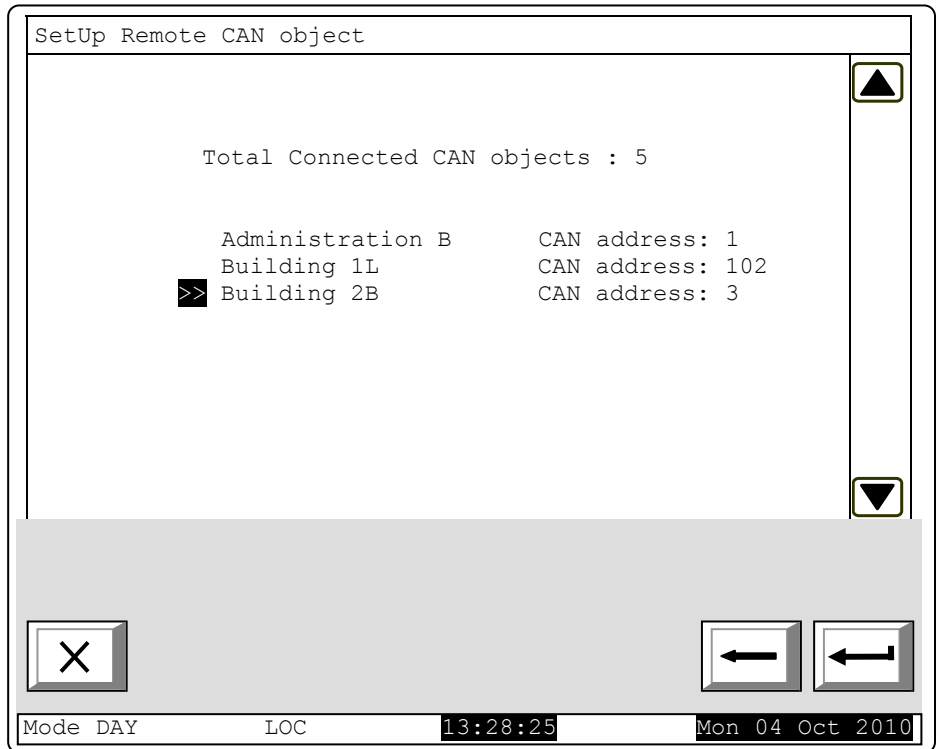

The Screen shows the total number of the connected objects and their list. In the list, each object is identified by name and CAN address.



Use buttons  and  on the right side of the panel to move the cursor to the location of the object for removal and press  to remove the object.

After deleting the selected object, the total number of connected objects is automatically reduced by one.



3.6.3.3. Review entered CAN object.

The function is used to view and / or change the parameters of a connected object from the local network.

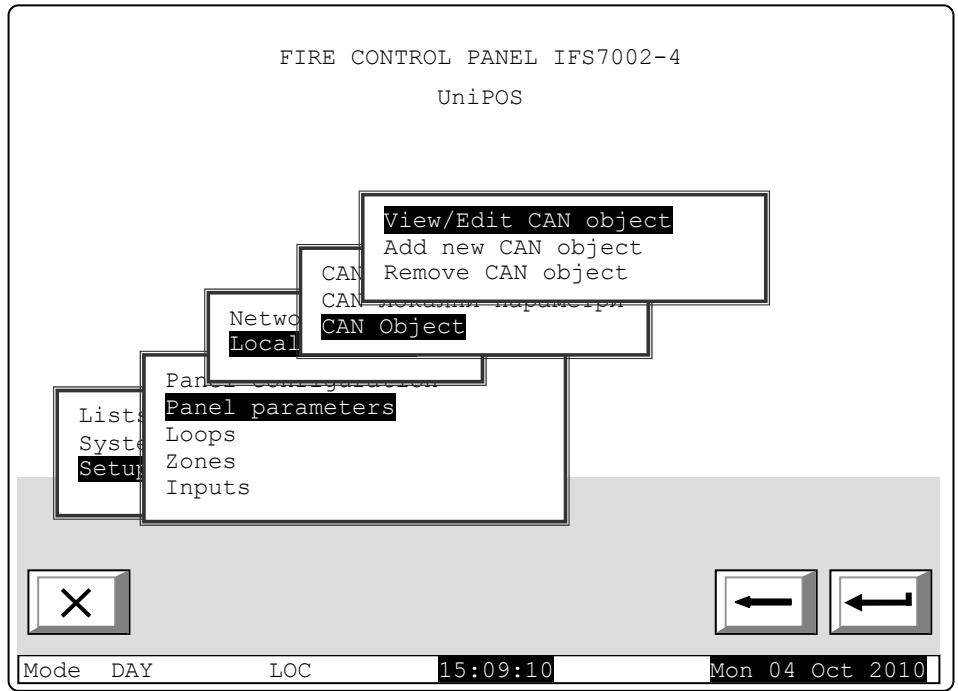

Choosing the option above allows for reviewing and adjustments going through the menus similar to those described above. Example: The screen shown contains information for three connected objects. By scrolling choose which object to be reconfigured.

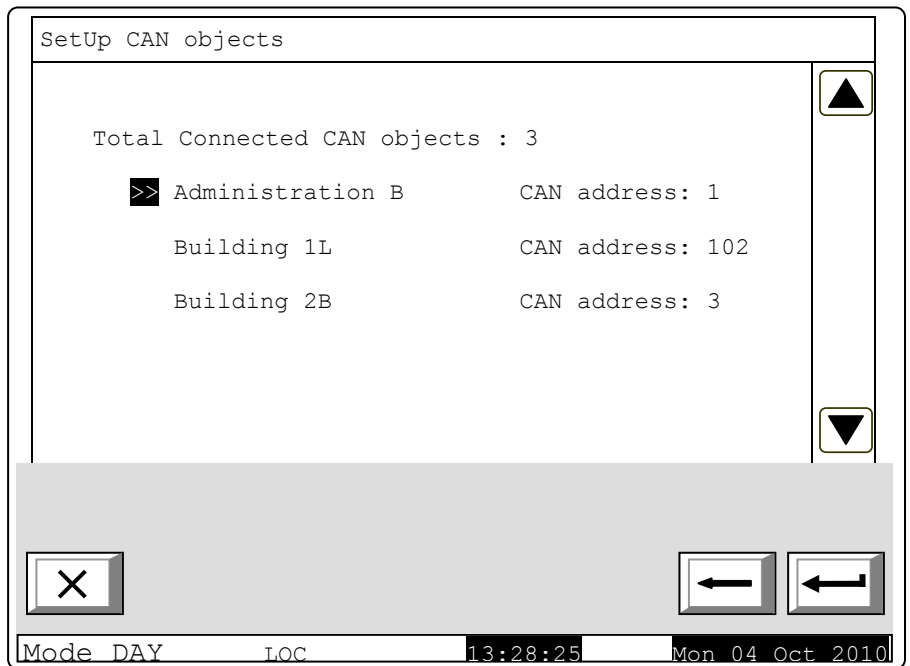

4. Set Up Menu „Set Up/Zones/Maintenance Remote Zones”

The Menu allows setting Zones from Remote Control Panels (CAN objects), connected to that Control Panel so that they will cause activation of the outputs assigned to that zone.

Upon entering Menu „Set Up/Zones/Maintenance Remote Zones” the following window appears:

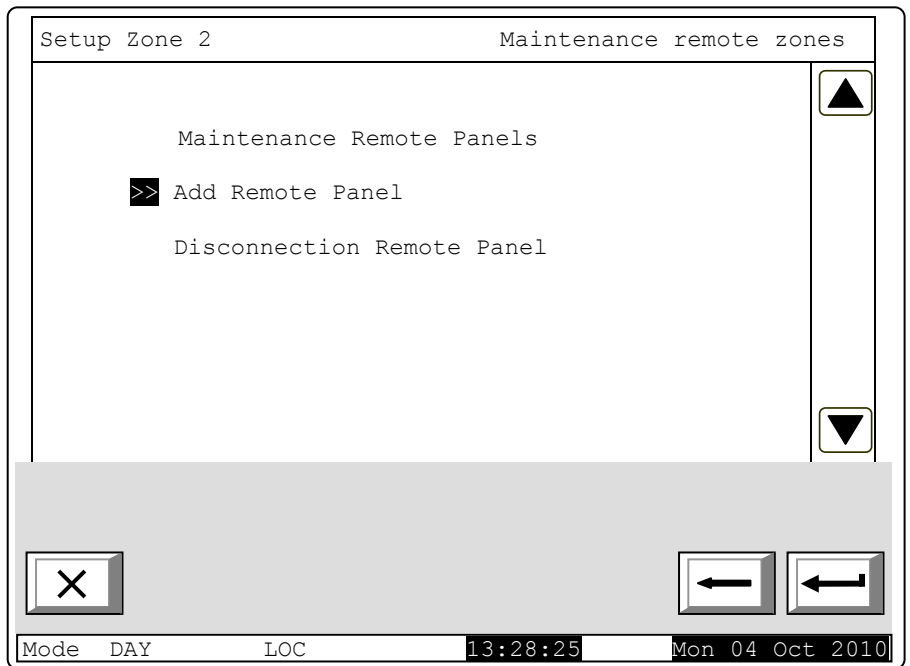

First add (select from the Remote Panels already entered) to the Remote Panel. Upon entering the Menu, a list of all Remote Panels, connected to this Control Panel and their addresses on the network is displayed.

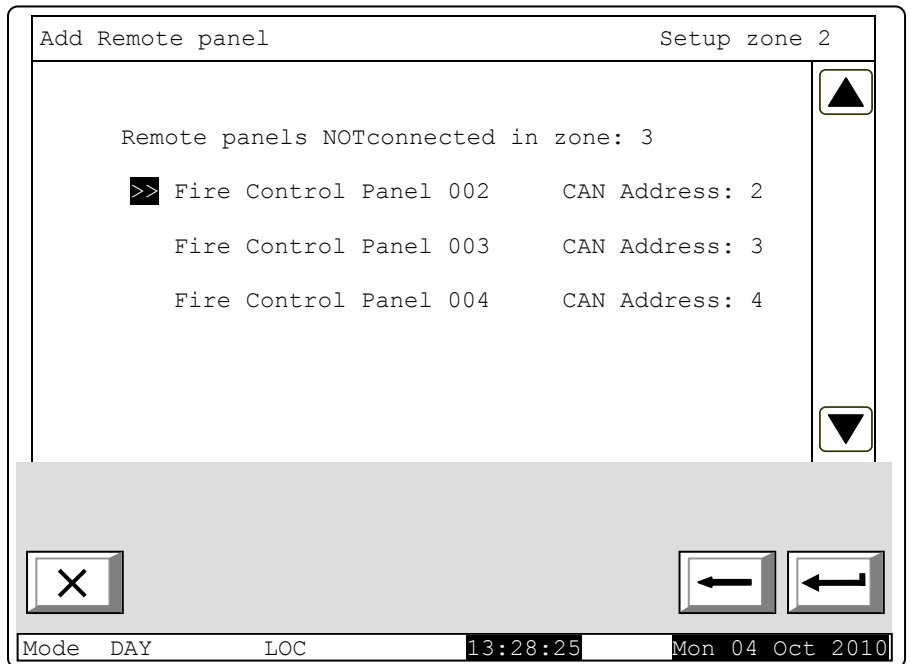

Upon selecting a Control Panel (Example: Fire Control Panel 02), the number of the Remote Panels is automatically reduced.

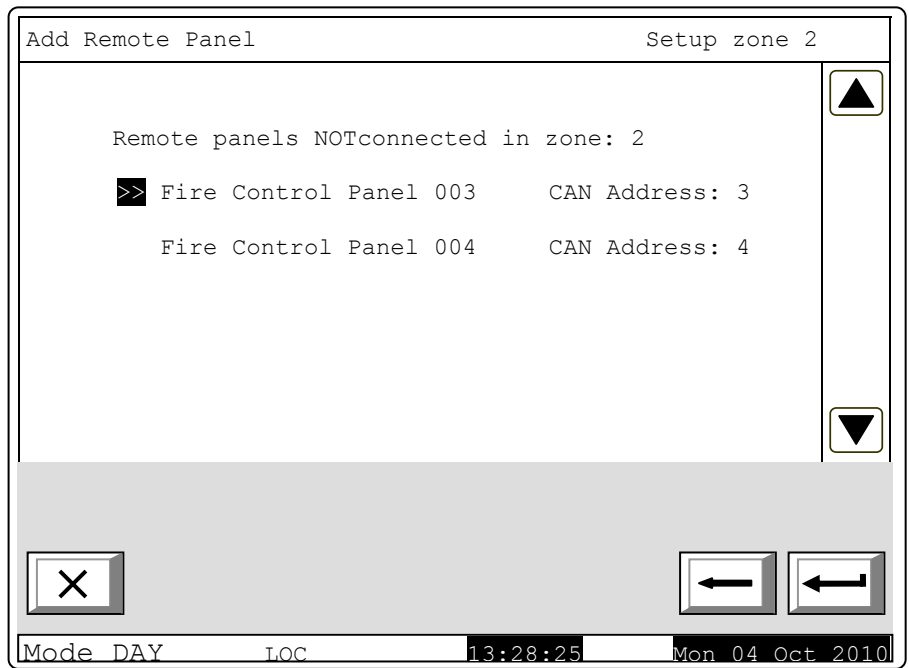

After selecting the Remote Panels, served by that zone go to menu "Maintenance Remote Panels" where appears a window "Select Remote Control Panel, by means of which zones will be served."

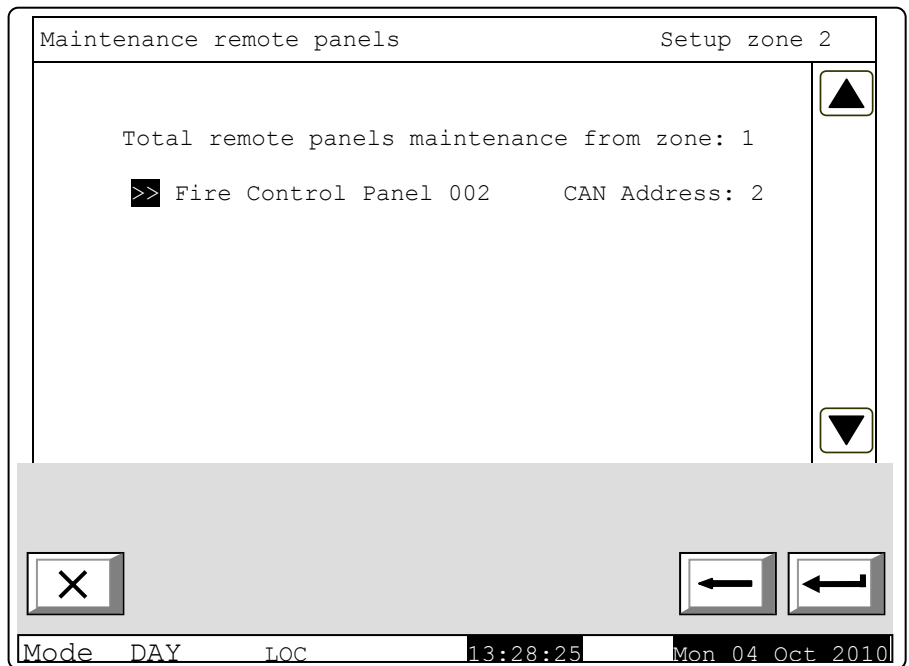

Upon selecting a Remote Panel, there appears a window for choosing the zone of the Remote Panel, which will be serviced from this zone.

In the field „Maintenance Zone in Remote Panel”, set the zone from the Remote Panel, that will be served of the set zone of the Local Panel. The example indicates that Zone 2 of the Local Panel will service Zone 5 of the Remote Panel with CAN Address 2.

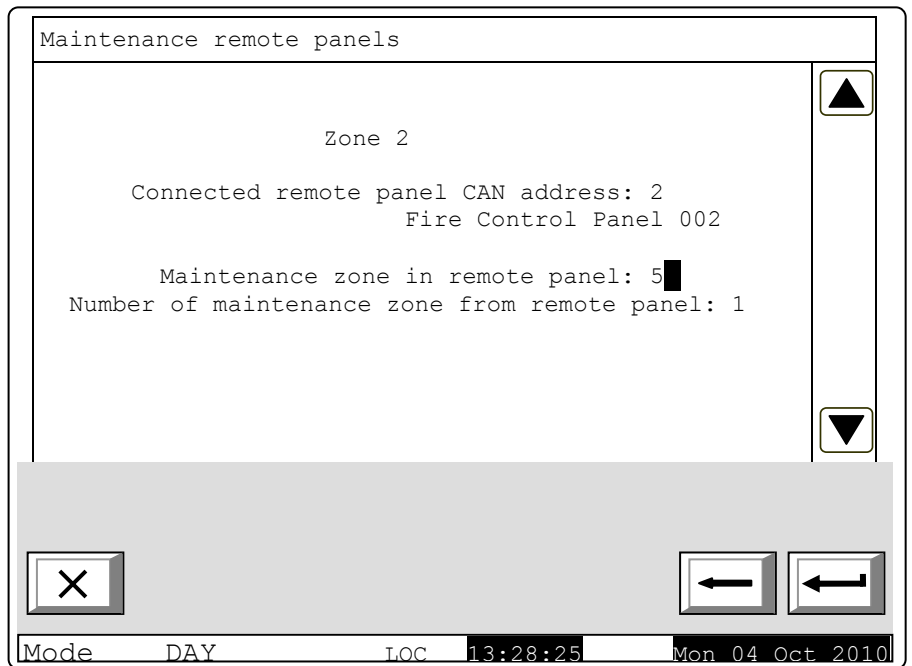

In the field „Total Zones, served by the the Remote Panel” set the number of the zones of the Remote Panel, serviced by the Local Panel.

Where necessary in order more zones from the Remote Panel to be serviced, and to activate the same outputs from the Local Panel, in the Local Panel fictitious zones should be made, from where the outputs to be activated can be set and the outputs of the Remote Panel can be assigned.

In Menu „Disconnection Remote Panel” can be performed deletion of the Remote Panel and respectively the zone, serviced by the set zone of the Local Panel.

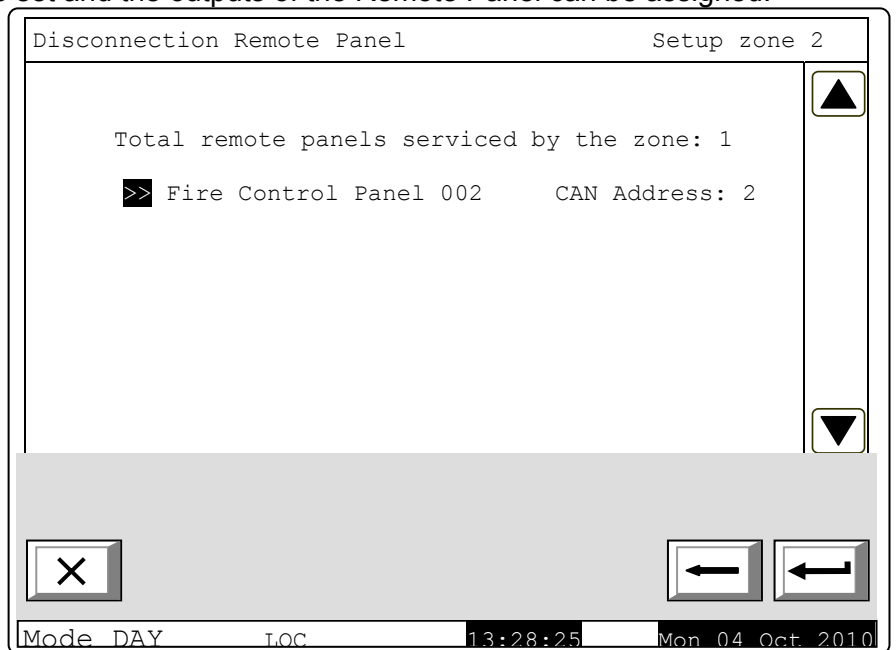

When confirming the deletion, the list of the Remote Panels, served by that zone is automatically updated.

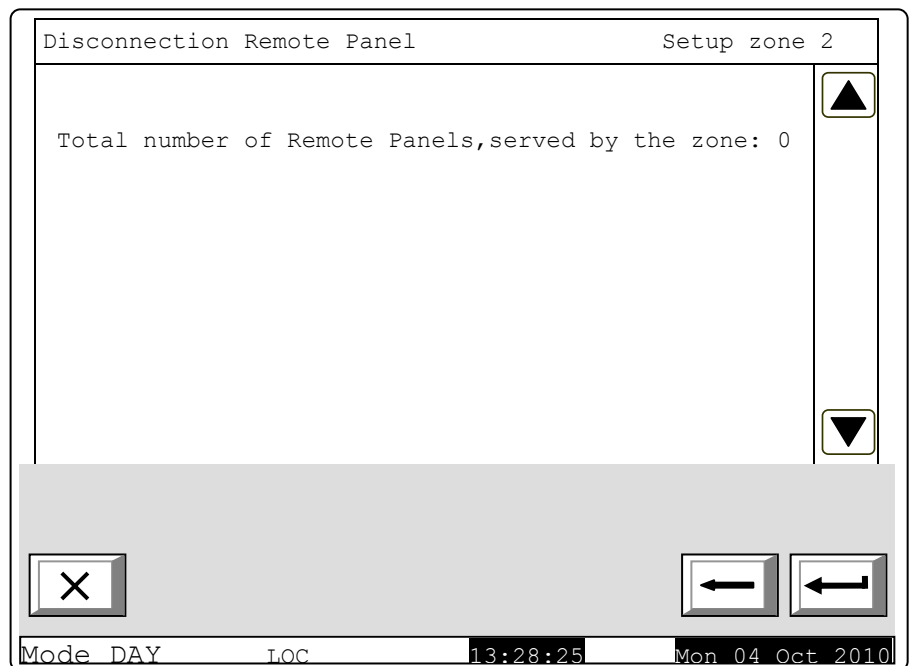

## 5. Examples for development of a CAN

Development of networks of connected devices may sometimes become a serious challenge for the designers. Typically, the sites have a complex structure and a versatile logic. Therefore a profound research of the network abilities and functions of fire alarm system IFS7002 is requested in order to guarantee development of systems that function properly and reliably. To read the present appendix you shall be previously acquainted with the menus of the fire control panel. Afterwards you easily and quickly will configure your system.

General features and considerations relevant to development of fire alarm networks based on IFS7002:

IFS7002 allows connection of up to 32 devices in a network. In case of remote objects repeaters can be used, provided in each control panel as an option.

The basic parameters that shall be configured in each control panel are displayed in the next figures. It would be useful to know, that when giving a name of a control panel, up to 20 symbols shall be used.

When using repeaters from object to another one, a maximum of 32 objects is allowed.

Another specific feature is that in the developed network an arbiter that controls the data stream and the priorities upon communication between control panels is available. This feature allows construction of durable IFS7002 CANs. Practically, each fire control panel may be configured as an arbiter (i.e. Master).

All other panels in the CAN under development shall be mandatory configured as Slave.

Another important term is "Connected Object". To make possible the remote communication with other control panels in the network, the parameters of the desired objects shall be manually entered.

Another specific is that the fire control panel, configured as a Master shall "see" all other control panels and in their configuration is shall be defined to "see" the Master control panel.

When control panels communicate without repeater, it is mandatory to select Repeater address: 0 and Connection type: Direct (as displayed in the examples).

When repeater is used, the CAN address of the repeater shall be defined, and the type of the connection shall be *Via repeater*.

### 5.1. Example of established network of 3 Control Panels IFS7002.

The panels are situated in Administration Building 1 and Building 2.

Each Panel consists of two boards, simulated as a pair of connected Control Panels, i.e network of 3 pieces.

IFS7002 with four loops in the set up part consists of setting of 6 of 2 loop (IFS7002) connected control panels .

- "Administration B" and "Administration L" - for the Control Panel in Building Administration
- "Building 1B" and "Building 1L" - for the Control Panel in Building 1
- "Building 2B" and "Building 2L" - for the control Panel in Building 2

As "Master" is set the Control Panel in Administration (min board in Building Administration).  
All others are set as „Slave“.

Master Control Panel monitors and communicates with all the Control Panels.

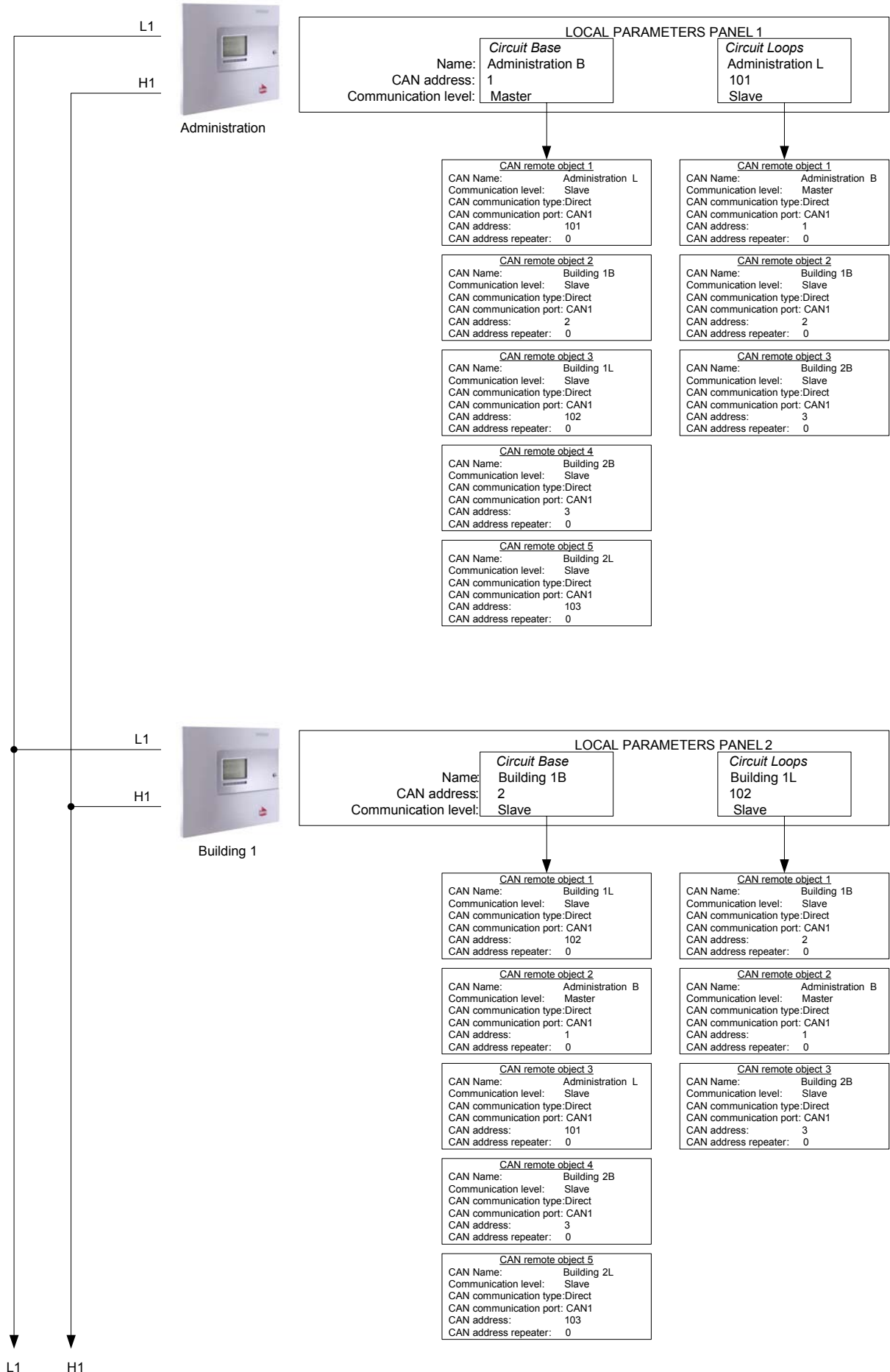

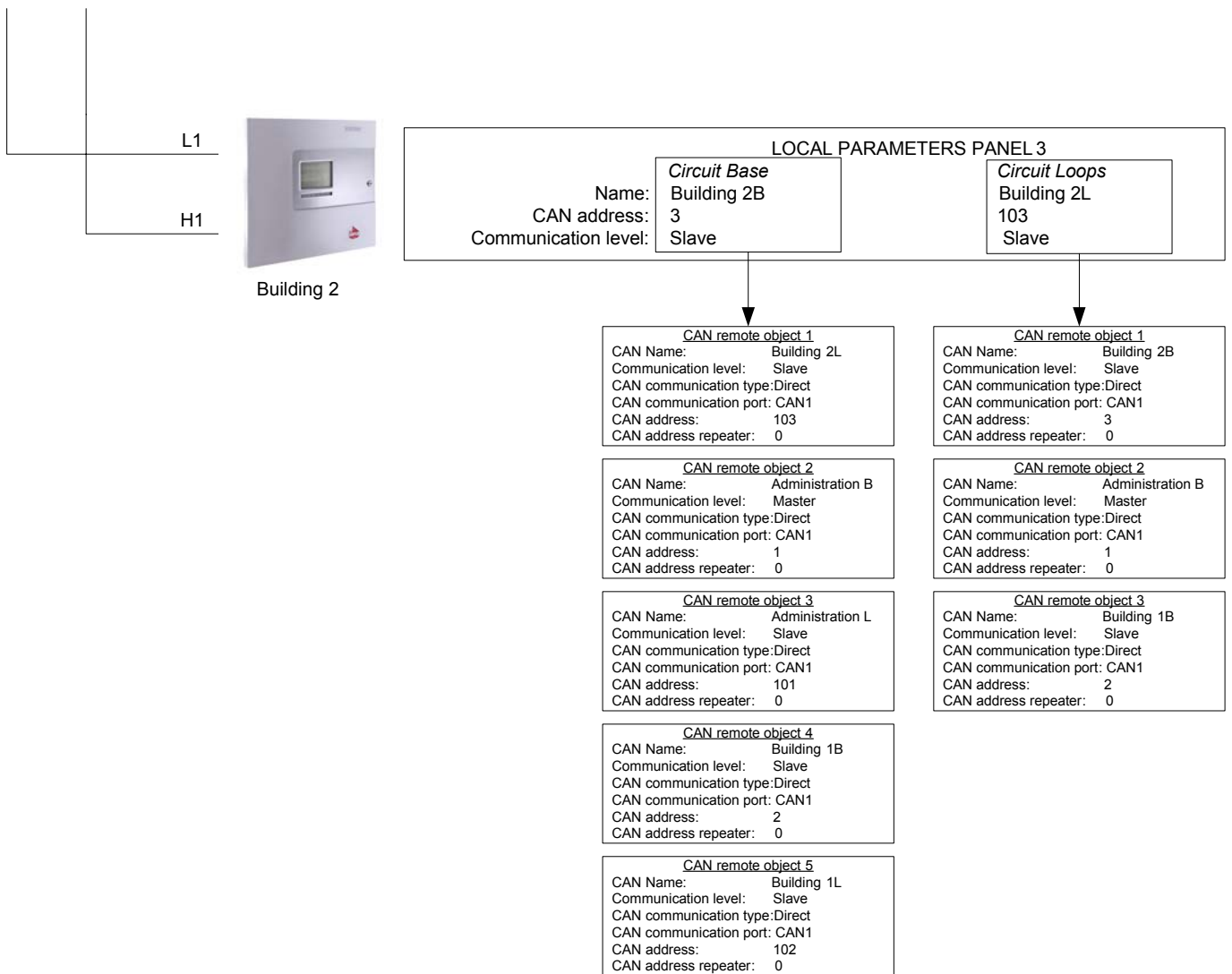

**5.2. Example of a network of Remote Control Panel for Indication and Control IFS7002R and three 4-loop Control Panels of IFS7002.**

The Remote Panel is located in the Security Station of the premise and from where the three panels are controlled and monitored.

The Control Panels are located in Administration, Building 1 and Building 2.

As „Master” is set the Remote Panel „Security”. The three panels in Administration Building 1 and Building 2 will be controlled from the Remote Panel.

All Control Panels are set as „Slave”.



