



Addressable-Conventional Modular System 7000-1MC



Instruction manual



Rev 3.0 - 13/10/2023

DOP № 155 /13.10.23

EN54-2:1997 / AC:1999 / A1:2006

EN 54-4:1997 / AC:1999 / A1:2002 / A2:2006

Table of Contents

Cautions and Warnings	4
1. Control panel general information	5
1.1 Provided Options:	5
1.2 Options with requirements	5
2. Components of Fire Alarm Panel 7000-1MC	8
2.1 Base –1 Loop module – TYPE 7000-1MC	8
2.2 Base-1 Loop Module description:	9
2.3 Conventional DIN module - TYPE DIN8CL	9
2.4 Basic I/O DIN module – TYPE BIO.....	10
2.5 Connection examples.....	12
2.6 Power supply unit (PSU) module	13
2.7 Panel repeater (optional).....	17
3. Connections of 7000-1MC components	18
3.1 How to connect base detector to loop	18
3.2 Branch connection	18
4. 7000-1MC Menu Organization	20
4.1 Menu “Status”	20
4.2 Menu “Disable” and “Inhibit”	21
4.3 Menu “System”	22
4.4 Menu “Service”	23
5. SETUP MANUAL 7000-1MC	24
5.1. Generating configuration file by panel 7000-1MC system	24
5.1.1 Service / Addressing / All	24
5.1.2 Service / Addressing / Auto-Config.....	25
5.1.3 Service / Maintenance	28
5.2 Basic programming of 7000-1MC-config.xml by WinUniConfig tool	28
5.2.1 Creation of D, A and P zones.....	28
5.2.1.1 Creation of Detection zones (D zones)	29
5.2.1.2 Creation of Alarm zones (A zones).....	29
5.2.1.3 Creation of Protection zones (P zones).....	29
5.2.1.4 Loop device configuration	30
5.2.2 Creation of BIO module devices	30
5.2.3 Sounder Defaults.....	31
5.2.4 Day-Night settings:.....	31
5.2.5 Sensor Defaults	32

5.2.6 Standard mode:.....	32
5.2.7 DIN8CL module:	33
5.3 Upload configuration file 7000-1MC-config.xml	33
5.3.1 Upload 7000-1MC-config.xml:	33
5.3.2 Panel software power off or Restart:	33
6. Coincidence modes – dependency on more than one alarm signal:	35
6.1 CI-Mode A	35
6.2 CI-Mode B.....	36
6.3 CI-Mode C.....	37
7. 7000-1MC Operational modes	39
7.1 Normal operation.....	39
7.1.1 Description	39
7.1.2 Indication	39
7.2 Fire mode.....	41
7.2.1 Description	41
7.2.2 Indication	41
7.2.3 Using keypad	42
7.3 Fault condition.....	44
7.3.1 Description	44
7.3.2 Indication	44
7.3.3 Using keypad	46
7.3.4 Faults list	46
8. Disable condition	49
8.1 Description	49
8.2 Indication	49
8.3 Disable Procedure	50
8.4 Using keypad	51
9. Inhibit condition	52
9.1 Description	52
9.2 Indication	52
9.3 Inhibit Procedure	54
9.4 Using Keypad.....	55
10. Test condition	55
10.1 Description	55
10.2 Indication	55
10.3 Procedure of Test.....	56

10.4 Using keyboard	58
11. Evacuation	59
11.1 Description	59
12. Event log	59
13. Status	60
14. Menu Disable.....	61
15. Menu Inhibit	65
16. Menu System.....	70
17. Menu Services	75
18. Menu Messages.....	80
19. Pre-installation	80
19.1 Location.....	80
19.2 Warranty	81
19.3 Mounting Height / Space Requirement for Control Panel	81
19.4 Power Supply Unit (PSU).....	83
19.5 Battery installation.....	84
19.6 Panel - Repeater Connection (RS-485).....	85
20. System information	87
21. Initialization of Loop devices	87
21.1 Exchange or replacement of devices of the same type	87
21.2 Swapped devices of different types.....	88
21.3 Replacing devices of different types	90
22. Manufacturer of re-initialization of fire alarm counter.....	90

Cautions and Warnings



Before commencing with Installation or operation of the panel, please read this manual carefully. If you are unclear on any point DO NOT proceed. Contact the manufacturer or supplier for clarification and guidance.



Only Skilled service personnel should undertake the Installation, Programming and Maintenance of this equipment.



This product has been designed to comply with the requirements of the Low Voltage Safety and EMC Directives. Failure to follow the installation instructions may compromise its adherence to these standards.



This Fire Alarm Control Panel is compliant with the requirements of EN 54-2:1997+A1:2006 & EN 54-4:1997+A1:2002+A2:2006
Where appropriate, reference is made in this manual to relevant sections of the EN-54 standard for clarification and to ensure that the installation is compliant with the requirements of EN-54.

1. Control panel general information

- Input voltage: 110V_{AC} - 240V_{AC}; 50/60Hz
- Pmax: 185W
- Operation temperature: -5° to +40°C
- Humidity: up to 93% without condensation
- Cabinet size: 419x204x520mm
- Weight: 17 kg including the batteries

1.1 Provided Options:

- Number of 7000-1MC (Loop Module) per Panel – 1 pcs
- Number of Loop Addressable Devices – up to 150 pcs
- Up to 5 conventional modules DIN8CL
- 8 conventional lines – up to 256 pcs conventional detectors per module / 1280 pcs conventional detectors per system.
- Up to 3 BIO modules
- Detection zone - contain up to 32 loop detectors, fire inputs or / and manual call points
- Detection zones – up to 64
- Alarm zones – up to 32
- Protection zones – up to 32
- Alarm zones and Protection zones can be activated from any Detection zones (One Detection zone cannot activate two Alarm zones)
- Configurable Week schedule (Day/Night mode) - sensitivity and logic change to detectors, delays change in Alarm zones
- Configurable sounder melodies in alarm and pre-alarm state (Warning-state) for every Alarm zone.
- Maximum number of addressable and conventional fire alarm devices – up to 20

1.2 Options with requirements

- Output to fire alarm devices
- Control of fire alarm routing equipment
- Output to fire alarm routing equipment
- Alarm confirmation input from fire alarm routing equipment
- Configurable output to fire protection equipment,
 - LED indication for activation
 - Input for the reception of a confirmatory signal from Fire protection equipment, indicated by means of separate indicator
- Fault monitoring fire protection equipment
- Delay to outputs, Day/Night mode
- Dependencies on more than one alarm signal

-
- CI Mode A (Detecting fire by double zone activation)
 - CI Mode B (Detecting fire by two zones activation)
 - CI Mode C (Detecting fire with inspection time)
 - Alarm counter – up to 9999 (can be delete at level access 4)
 - Fault signals from points
 - Total loss of power supply
 - Output to fault warning routing equipment
 - Disablement of addressable points

Addressable Heat Detector type of response:

- **A2R** – Detector activates by temperature increasing
- **A2S** – Detector do not respond below 54°C

Addressable Smoke Detector sensitivity:

- **Low**
- **Medium**
- **High**

Addressable Combine detector sensor logic:

- **only heat detection**
- **only smoke detection**
- **Smoke or Heat detection** (combine detector goes into fire mode when either smoke or heat detector are activated)
- **Both** (combine detector goes into fire mode when smoke and heat detector are activated)

Detection zone (DZ) – is defined as a zone with one or more points (automatic fire detectors, gas detectors, manual call points, Inputs) that logically belong together, determined by geographical/functional parameters. Each zone allows devices only from one loop or one BIO.

Alarm zone (AZ) – is activated by one or more detection zones. Within the same alarm zone, alarm sounders give the same audible signal.

Geographically associated alarm zones can be defined as *next zones*, such can activate outputs for alarm zones adjacent to the incident. Each zone allows devices only from one loop or one BIO.

Basic Input Output Module (BIO) – DIN module equipped with 2 relay outputs, 2 monitored outputs 2 monitored inputs and 1 user output. Can be connected up to 3 modules per panel. Each input and output can be configured with different functions.

Protection zone (PZ) – is activated by one or more detection zones. Containing and control of outputs of the composition of Loop's devices and BIO modules. Each zone allows devices only from one loop or one BIO.

Fire Alarm Device (FAD) – output intended to control conventional sounders from BIO

Fire Protection Equipment (FPE) – configurable BIO output or loop input/output module, manages peripheral devices as fire doors, fire curtains, access control, lifts, and escalators, isolating and suppressing fire progress, as well as providing an escape route

Fault monitoring input of fire protection equipment (FPE Fault Input) – receive fault warning signals from controls of automatic fire protection equipment

Fire protection equipment input confirmation (FPE Activation Input) – Monitoring Input programmable for confirmation of receiving activation of FPE output

Fire Brigade Routing Equipment (FBRE) – Monitoring Output – activated in case of fire event. Refer to EN-54-2, p.7.9 – this output signals for fire event to fire alarm routing equipment

Fire Brigade Routing Equipment confirmation input (FBRE conf. input) – configurable BIO monitoring input, programmable for confirmation of receiving signal from fire alarm routing equipment (FBRE)

Fault Warning Routing Equipment (FWRE) – Monitoring Output – normal state continuously ON, in case of Fault event Output is in state OFF. Refer to EN-54-2, p.8.9- this output signals for fault warning condition and signal are also warned in case of de-energized Control panel

Fault Warning Routing Equipment confirmation input (FWRE conf. input) – configurable BIO monitoring input, programmable for confirmation of receiving fault event

Table 1: Possible programming of Basic Input Output module (BIO) devices

	Relay 1	Relay 2	Monitoring Output 1	Monitoring Output 2	Monitoring Input 1	Monitoring Input 2	User Output
FAD	√ *	√ *	√	√			
FPE	√ *	√ *	√	√			
FBRE	√ *	√ *	√	√			
FWRE	√ *	√ *	√	√			
Common	√	√	√	√	√	√	
FBRE conf					√	√	
FWRE conf					√	√	
Fire Input					√	√	
FPE Fault					√	√	
FPE Activation					√	√	
Ext. Fault					√	√	
Fire Enter							√
Fire Leave							√
Fault Enter							√
Fault leave							√

**Note! Relay outputs configured as Fire alarm device (EN54-2, p. 8.2.5 a)), Fire protection equipment (EN54-2, p. 8.2.4 f)), Fault warning routing equipment (EN54-2, p. 8.2.4 g)) or Fire alarm*

routing equipment (EN54-2, p. 8.2.5 b)) are non-compliant configurations according EN54-2! For full compliance to EN54-2 use only Monitored output option to configure these outputs.

** Note is also applicable for configuration of addressable Input Output device 7203M*



Access Level 1 – gives information about the state of the control panel and user intervention as mute the panel buzzer - no user key required



Access Level 2 – gives information about the state of the control panel and the fire devices and user intervention as mute the Sounders, panel buzzer, Start an Evacuation - require turned user key

Access Level 3 – gives permission to programming and changing configuration of the Control panel - it's required placed turned user key and valid password (default pass F1F1F2F2) and use of configuration tool WinUniConfig.exe

- “AL3-a” gives access over a password;
- “AL3-b” gives access to the internal part of the panel for a maintenance purpose - PSU, fuses, modules, etc.;

Access Level 4 – gives permission to reset fire counter (and all pre-stored setting as disables) with Command Prompt” application and DFUprog.exe. Required placed and turned user key and entered valid password (default pass F1F1F2F2).

2. Components of Fire Alarm Panel 7000-1MC

2.1 Base –1 Loop module – TYPE 7000-1MC

- Base-1 Loop DIN module is mandatory for panel 7000-1MC. Panel includes only one module, always installed on first position of DIN rail, next to the Power supply module. Base-1 Loop DIN module is directly power supplied over connector.
- Module includes detachable and standard connector for interface connection.
- RS485 for connection with Panel repeater.
- USB host – Upload/Download panel configuration (requires Access level 3).

7000-1MC Base-1 Loop Module preview:

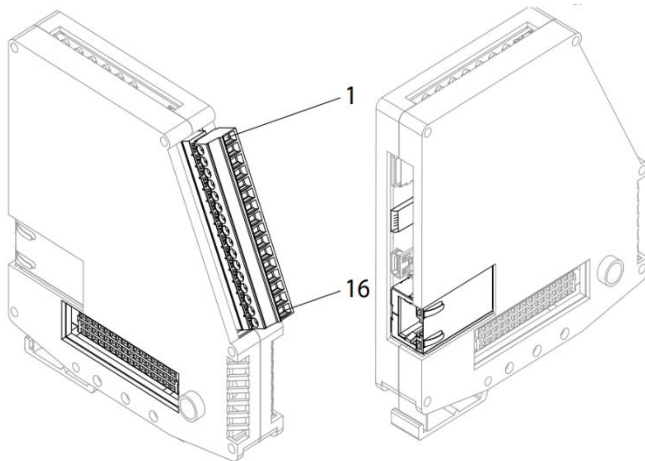

- | | |
|-------------------|------------|
| ① Loop 1“+” start | ⑨ Not Used |
| ② Earth | ⑩ Not Used |
| ③ Loop 1“-” start | ⑪ Not Used |
| ④ Loop 1“+” end | ⑫ Not Used |
| ⑤ Earth | ⑬ RS485 -A |
| ⑥ Loop 1“-” end | ⑭ RS485 -B |
| ⑦ Not Used | ⑮ Earth |
| ⑧ Not Used | ⑯ Earth |

2.2 Base-1 Loop Module description:

The circuit serves up to 150 addressable devices of the "M" series, Heat Detector FD7120M, Smoke Detector FD7130M, combine Detector FD7160M, Manual Call Point FD7150M, Input-Output Module 7203M, CNG Detector 71CNG, Sounder 7206M, Base-Sounder 7205, manufactured by UniPOS LTD. The maximum loop length is 1,500 m, with a fire alarm cross section of 1.5 mm².

Continuity of the transmission path in the addressable loop

Each M-series addressable loop device has a built-in short-circuit isolator. This allows the addressable loop to continue to function in the event of a single short circuit or break in the cable installation.

The circuit has the possibility of independent power supply and the ability to autonomously receive signals from each end of the circuit - in case of a short circuit, the devices divide the positive wire between the event point and limit the spread of the short circuit. fault for broken circuit and activated isolator of two adjacent devices.

Technical Data:

- Connecting type: — DIN rail
- Modules per panel — 1
- Maximum Consumption: — 65-70mA/5V_{DC}
- Maximum Loop Device Consumption: — 220mA
- Power supply (ensured by PSU module): — (27,6 +1/-8)V_{DC}

2.3 Conventional DIN module - TYPE DIN8CL

Each conventional DIN8CL module incorporates eight conventional lines. Each conventional line can service up to 32 conventional devices: Fixed temperature Heat Detector FD8020S, Rate of Rise Heat Detector FD8020R, Smoke Detector FD8030, Flame Detector FD8040, Combined Detector FD8060, Manual Call Point FD3050.

7000-1MC system can support up to 5 pcs DIN 8CL modules up to 40 conventional lines, up to 1280 conventional detectors. Conventional lines are terminated with EOL element. Conventional line short - all conventional detectors won't be in operation.

Conventional DIN8CL module preview

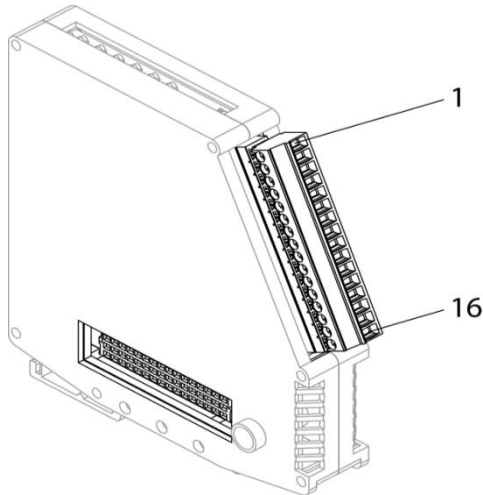

- | | |
|--------------------|--------------------|
| ① Conv. line 1 “+” | ⑨ Conv. line 5 “+” |
| ② Conv. line 1 “-“ | ⑩ Conv. line 5 “-“ |
| ③ Conv. line 2 “+” | ⑪ Conv. line 6 “+” |
| ④ Conv. line 2 “-“ | ⑫ Conv. line 6 “-“ |
| ⑤ Conv. line 3 “+” | ⑬ Conv. line 7 “+” |
| ⑥ Conv. line 3 “-“ | ⑭ Conv. line 7 “-“ |
| ⑦ Conv. line 4 “+” | ⑮ Conv. line 8 “+” |
| ⑧ Conv. line 4 “-“ | ⑯ Conv. line 8 “-“ |

Technical Data:

- Connecting type: – DIN rail
- Connecting line: two-wire shielded fire rated cable (recommended 0,75 – 1.5mm²)
- Lines per module – 8
- End Of Line (EOL) – 3,0kΩ resistor
- Modules per panel – 5
- Maximum Consumption from one line: – 95mA/24V_{DC}
- Power supply (ensured by PSU module): – (27,6 +1/-8) V_{DC}

2.4 Basic I/O DIN module – TYPE BIO

Basic I/O DIN module consists of two monitored inputs, two monitored outputs, two relay outputs and one power user output.

In each panel can be mounted up to 3 pcs. BIO modules.

Installation of BIO module on DIN rail must be next to the 7000-1MC on the DIN rail. All BIO modules shall be stacked together without mixing different types of module e.g., installing module between two basic I/O DIN modules is not allowed.

All BIO inputs and outputs do not take any addresses from loop address space.

BIO module preview

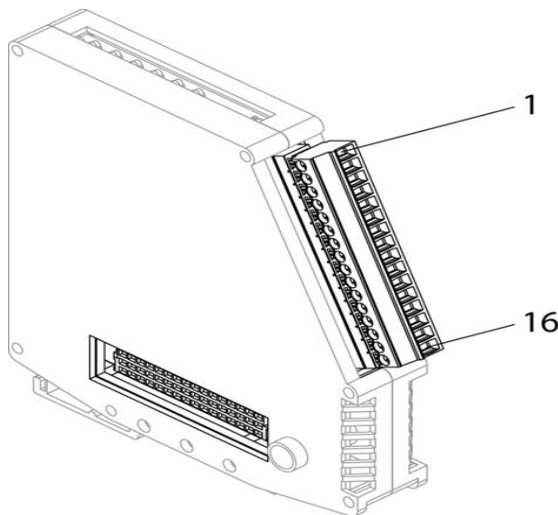

- | | |
|--------------------------|---------------------------|
| ① Relay Output 1 – NO | ⑨ Monitored Output 2 “+” |
| ② Relay Output 1 – COM | ⑩ Monitored Output 2 “-” |
| ③ Relay Output 1 – NC | ⑪ Monitored Input 1 “+” |
| ④ Relay Output 2 – NO | ⑫ Monitored Input 1 “GND” |
| ⑤ Relay Output 2 – COM | ⑬ Monitored Input 2 “+” |
| ⑥ Relay Output 2 – NC | ⑭ Monitored Input 2 “GND” |
| ⑦ Monitored Output 1 “+” | ⑮ User Output “+” |
| ⑧ Monitored Output 1 “-” | ⑯ User Output “GND” |

Technical Data:

Monitored output:

- number of outputs per module – 2pcs
- Type – potential
- Electrical characteristics – $(27,6 + 1/-8)V_{DC}/0,7A$
- End Of Line (EOL) – 1,5k Ω resistor

*EOL shall be connected to pins 7 – 8 and 9–10 for proper work of the monitored output

Relay outputs:

- Type – potential free, switching
- Electrical characteristics – 0,5A/125V_{AC}; 1A/30V_{DC}

Monitored inputs:

- number of inputs per module – 2pcs
- Type – monitored
- EOL – 3,3k Ω resistor

*EOL shall be connected to pins 11–12 and 13–14 for proper work of the monitored input

User output

- number of outputs per module – 1pcs

- Type – potential
- Electrical characteristics – $(27,6 + 1/-8)V_{DC}/0,7A$

Transmission paths circuit lengths

The voltage drop on each transmission path circuit should be calculated to ensure that the minimum voltage at the end of the circuit exceeds the minimum required by applicable devices such as FAD, FPE, FBRE or FWRE at the minimum circuit output voltage.

The voltage at the end of the circuit is given by:

Minimum Device Voltage = $V_{OUT(MIN)} - (I_{ALARM} \times R_{CABLE})$

Minimum Output Voltage ($V_{OUT(MIN)}$) is equal to minimum battery voltage $21,5V - 0.5V = 21V$

Load Current (I_{ALARM}) is the sum of the loads presented by activated connected devices.

Cable Resistance (R_{CABLE}) is the sum of the cable resistance in both cores x cable length.

Cable Resistance (R_{CABLE}) for 1.0mm² is $0.036\Omega / m$

Cable Resistance (R_{CABLE}) for 1.5mm² is $0.024\Omega / m$

Cable Resistance (R_{CABLE}) for 2.5mm² is $0.015\Omega / m$

Insulation Resistance (Core-Core and Core Screen)	>2M Ω
---	--------------

All EOLs are included in zip together with BIO package.

Each BIO hardware input and output can be configured with different function purpose regarding Table 1: Possible programming of Basic Input Output module (BIO) devices. This can be done using WinUniConfig configuration program for 7000-1MC panel series.

Monitored output load specification*

BIO Module Devices	Short	Creeping Short	Normal	Creeping Open	Open
Output TYPE E (FBRE) Load	<35 Ω +/- 10%	- 10%	1500 Ω +/-5 %	+ 10%	<2700 Ω +/-10%
Output TYPE J (FWRE) Load					
Output TYPE C (FAD) Load					
Output TYPE H (FPE) Load					

Monitored input load specification*

BIO Module Devices	Short	Creeping Short	Normal	Creeping Open	Open
Input	<508 Ω +/- 10%	- 10%	3300 Ω	+ 10%	<4950 Ω +/-10%

* Creeping functions are available only after BIO devices calibration from the panel

2.5 Connection examples

- Example of connecting activation button to BIO Monitoring Input:

Mains Power Connections

The fire panel must be on a separate circuit line with fuse 6A.

1. Turn off fuse 6A in the fuse box.
2. A 3x0.75mm² cable is required for the connection of the fire panel and the fuse box.
3. Switch ON fuse 6A in the fuse box and connect the fire panel batteries.

Note: Isolation must be kept on (Live, Neutral and Earth) as  the mains cable as close to the terminal points as possible.

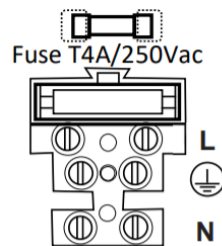

The panel must be connected to the supply earth through the power cable.



Connect the Control panel to the mains supply via a readily accessible disconnect-device (isolation switch) and suitable incorporated in the building installation wiring. The mains cable should be at least 0.75mm² cable rated at 250V and fused via a 6A anti-surge fuse.

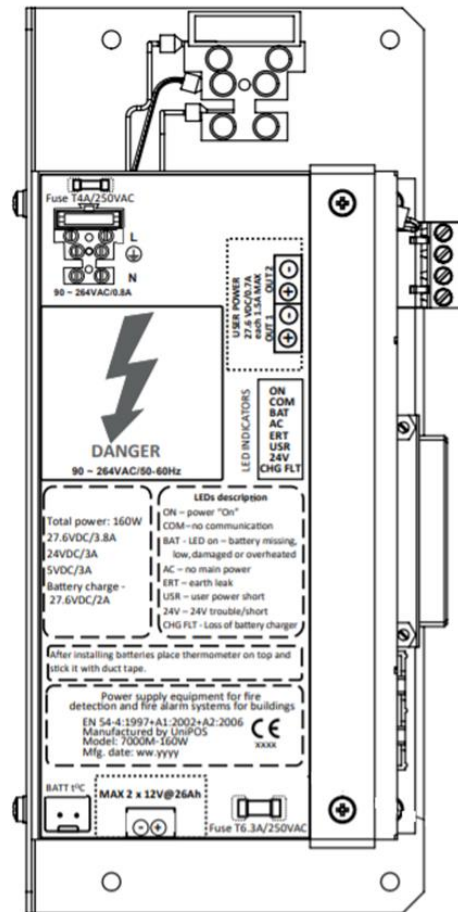

Technical Data:

Main power:

- Input voltage: – 110V_{AC} - 240V_{AC}; 50/60Hz
- P_{max} – 185W
- Max. current consumption at 230V_{AC} – 0,8A
- Max. current consumption at 120V_{AC} – 1,6A
- cable connection – 3x0,75mm²
- inrush peak current consumption at 120V – 35A
- mains power fuse – 4A

Batteries (not included):

- capacity of recommended batteries – 12Ah/12V
- number of batteries – 2
- battery type – lead, gel electrolyte
- maximum size batteries – 151mm x 98mm x 94mm +/- 2mm
- maximum drawn current – 4A
- type of connection – serial
- connection type to batteries – bolt type M5 screw
- Battery fuse – 6A
- maximum internal resistance for connected battery pack – 36mΩ
- I_{min}/I_{maxa} /I_{maxb} – 0,2/3,8/5,8A

Note: If power to the system is supplied exclusively from the batteries (in case of a power supply failure) and the voltage is below 21,5V, the Power Board 7000-1MC-PSU160 will perform a controlled shutdown (total loss of power). When battery voltage is lower than 19,5V the system will shut down automatically.

Battery Charging

The charging voltage is temperature controlled, so optimal charge for each temperature is maintained.

The power supply unit limits the battery charging current to 2A.

Attention: The battery temperature sensor must be placed on the batteries. If the sensor is placed in warmer or colder places, the charging voltage will be wrong, and lower battery capacity and/or shorter battery life may be expected.

The charging voltage at 25°C is 27,6V_{DC}.

Battery Resistance Measurement

Every hour, battery voltage is measured under 5A load (built in Resistor), this load is powered from the batteries for a period of 200ms. Battery is “GOOD” if voltage is not decrease 22V. This measurement procedure started when the battery voltage was over 25V.

Battery Input

Battery input is protected by an electronic short-circuit detector and a regular fuse. If a short circuit is detected, the battery relay will turn OFF within approx. 50ms. System will then report “No Battery “.

System Units

Fire Alarm Control Panel - 250mA/27V,6_{DC} (idle) Max. 3,8A/27,6V_{DC}

Repeater Panel - 30mA/27,6V_{DC} (idle) Max. 130mA/27,6V_{DC} (led test indication)

Power Design Consideration

The power supply has 5.8A/27,6V_{DC} available, as 2A/27,6V_{DC} is reserved for battery charging.

2.7 Panel repeater (optional)

Panel repeater BUI contains two types of modules - LCD with keyboard and LED's zonal boards. Repeaters can receive all data from the main panel. Functions of control panel and LCD with keyboard repeater are fully mirrored.

Repeater LCD with keyboard preview

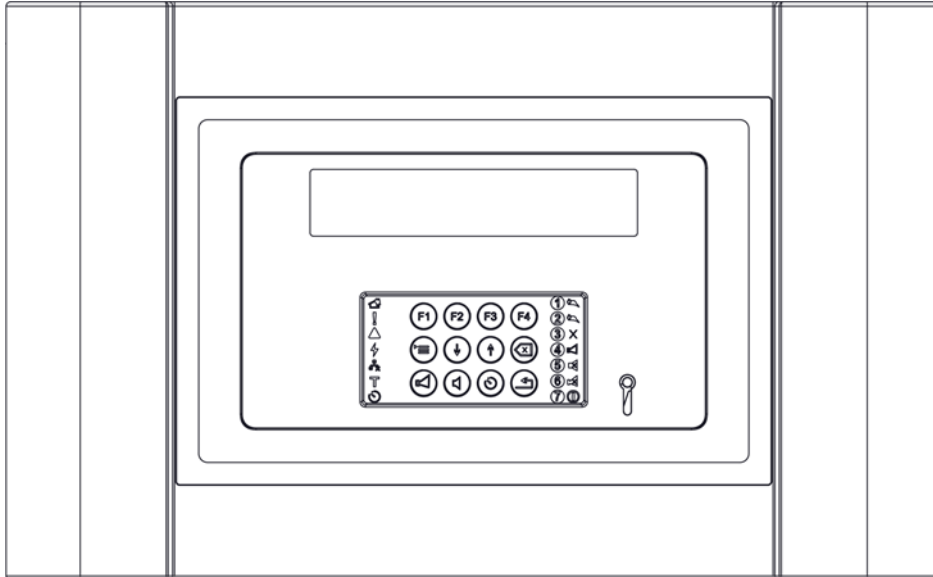

Technical Data:

- Connecting type: – shielded wire, twisted pair
- Communication interface – RS485
- Max. Repeaters per panel – 1
- Current Consumption – 50mA/27,5V_{DC}
- Connection distance – approx. 1000m*
- Power supply – 21.5V_{DC} - 28V_{DC}**

*The maximum transmission distance is bounded by the cable properties

** In case the connection shall be up to 100m far from the panel, its power supply output can be used to ensure supplying of the repeater.

Important: Always connect shielding (screen) core to Earth terminal from one side, shown as position 6 p.21.7. The other side shielding core shall be connected to terminal 16 of the firstly installed Loop controller 1 on the DIN rail.

3. Connections of 7000-1MC components

3.1 How to connect base detector to loop

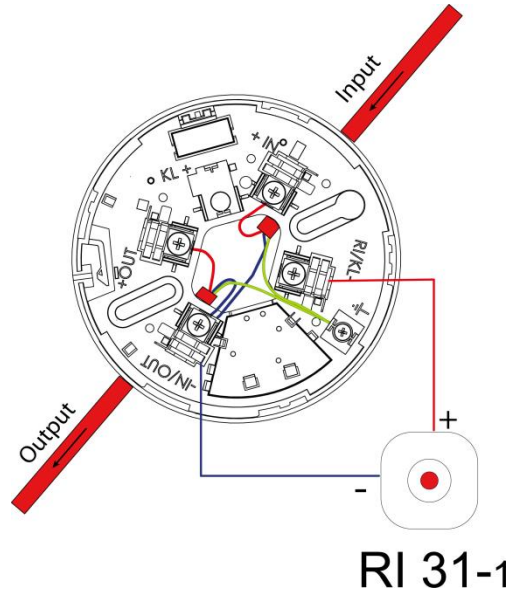

Always connect screen cable on both sides of the cable to the Earth terminal located on the base 7000.

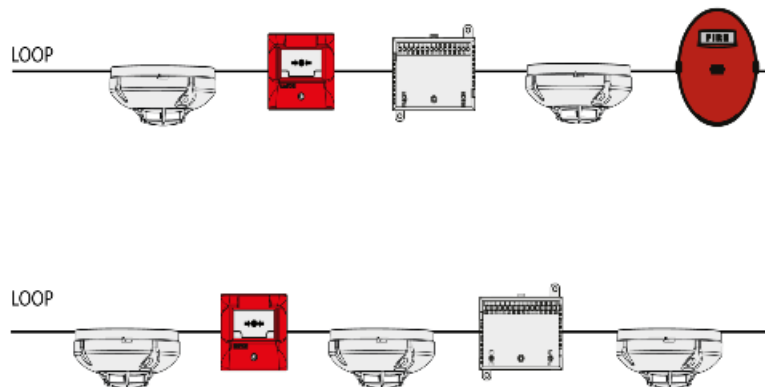

3.2 Branch connection

Branch connections up to 32 fire detectors in a single branch. Number of branches depends only on the number of all detectors 150 (example: One branch-off with 32 pcs. detectors, loop detectors 118 pcs. Two Branch off with 32 pcs. detectors at each branch, loop detectors 86 pcs. etc.)

Note 1: using branch configuration in loops is not recommended due to possible disconnection of a lot of devices in case of branch interruption or short circuit faults.

Note 2: Limitations per branch-up to 3 addressable sounders, up to 3 addressable input/output devices or up to 3 gas detectors.

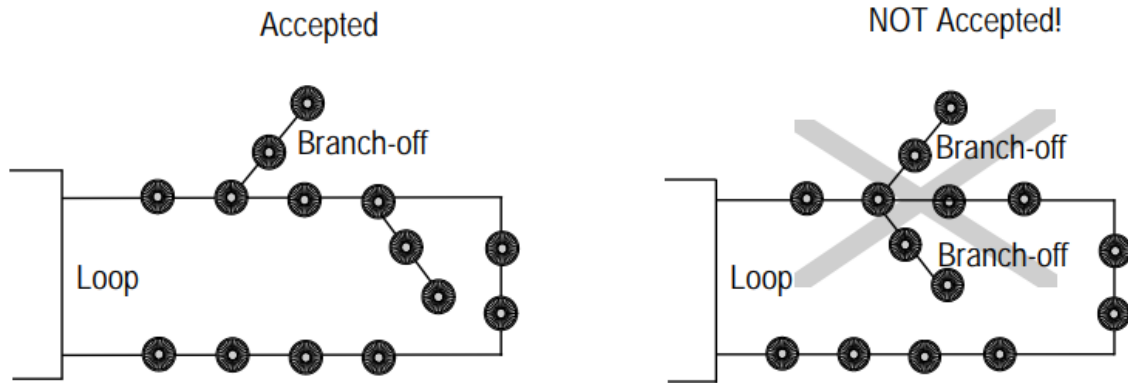

The shown branch connection starts after the loop device, if needed to start before loop device the branch must be connected to +IN instead of +OUT.

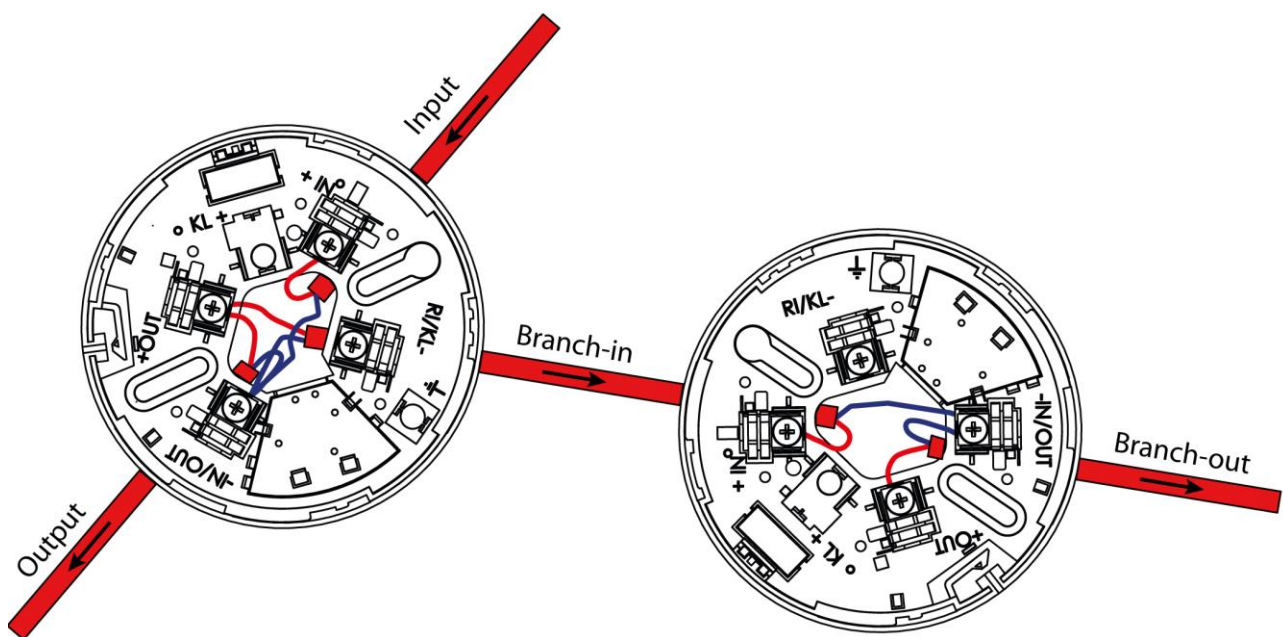

4. 7000-1MC Menu Organization

4.1 Menu “Status”

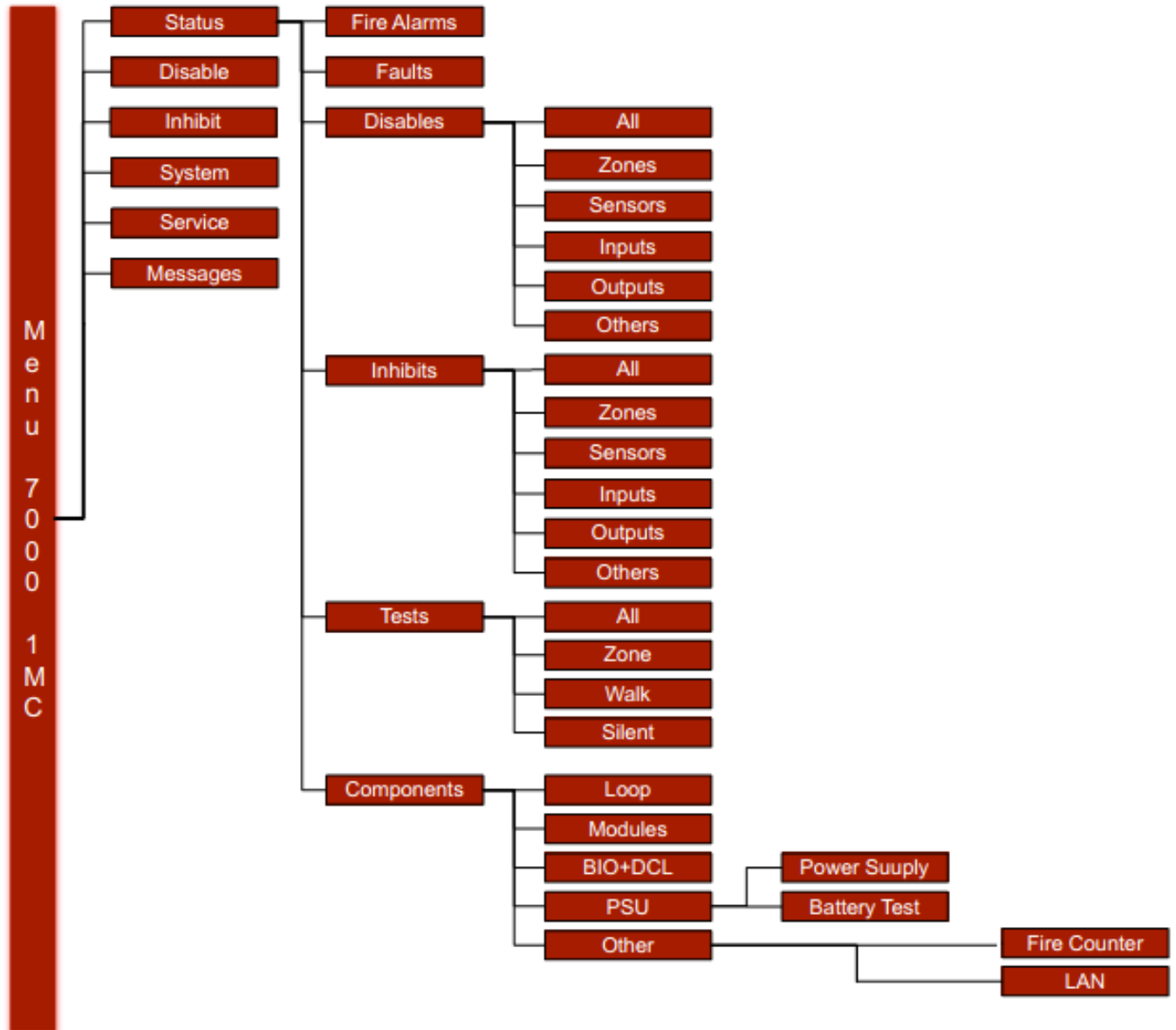

4.2 Menu “Disable” and “Inhibit”

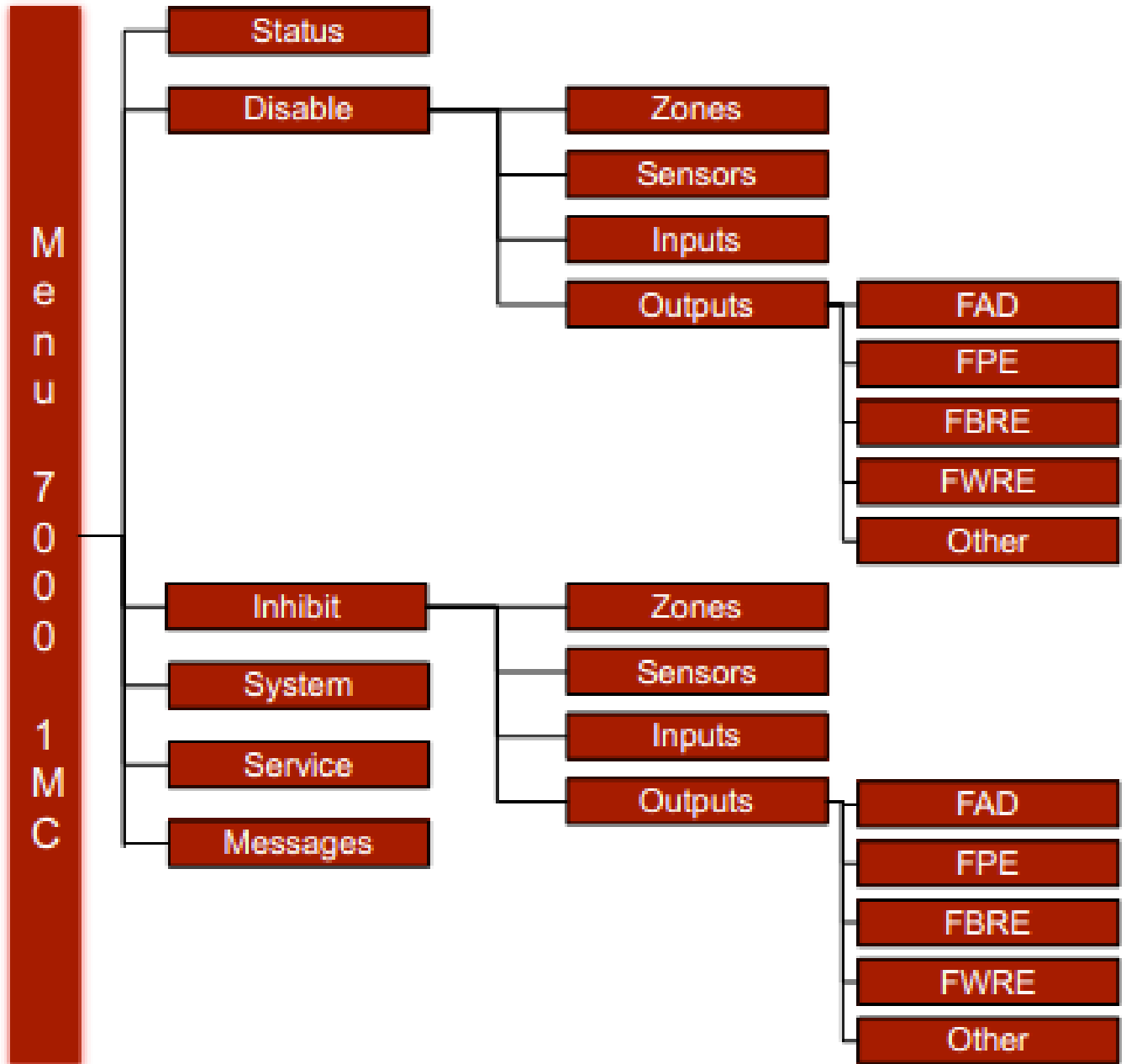

4.3 Menu “System”

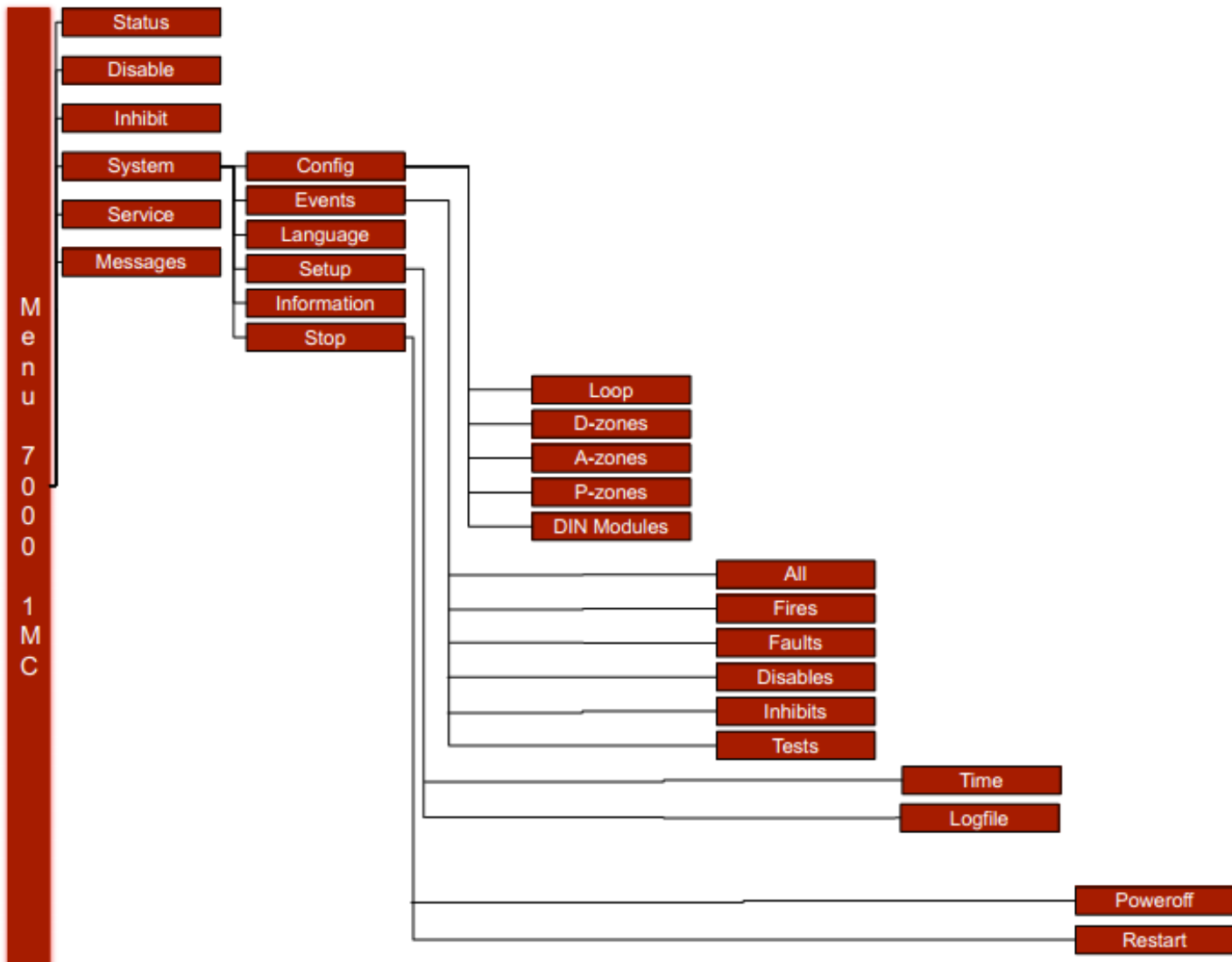

4.4 Menu “Service”

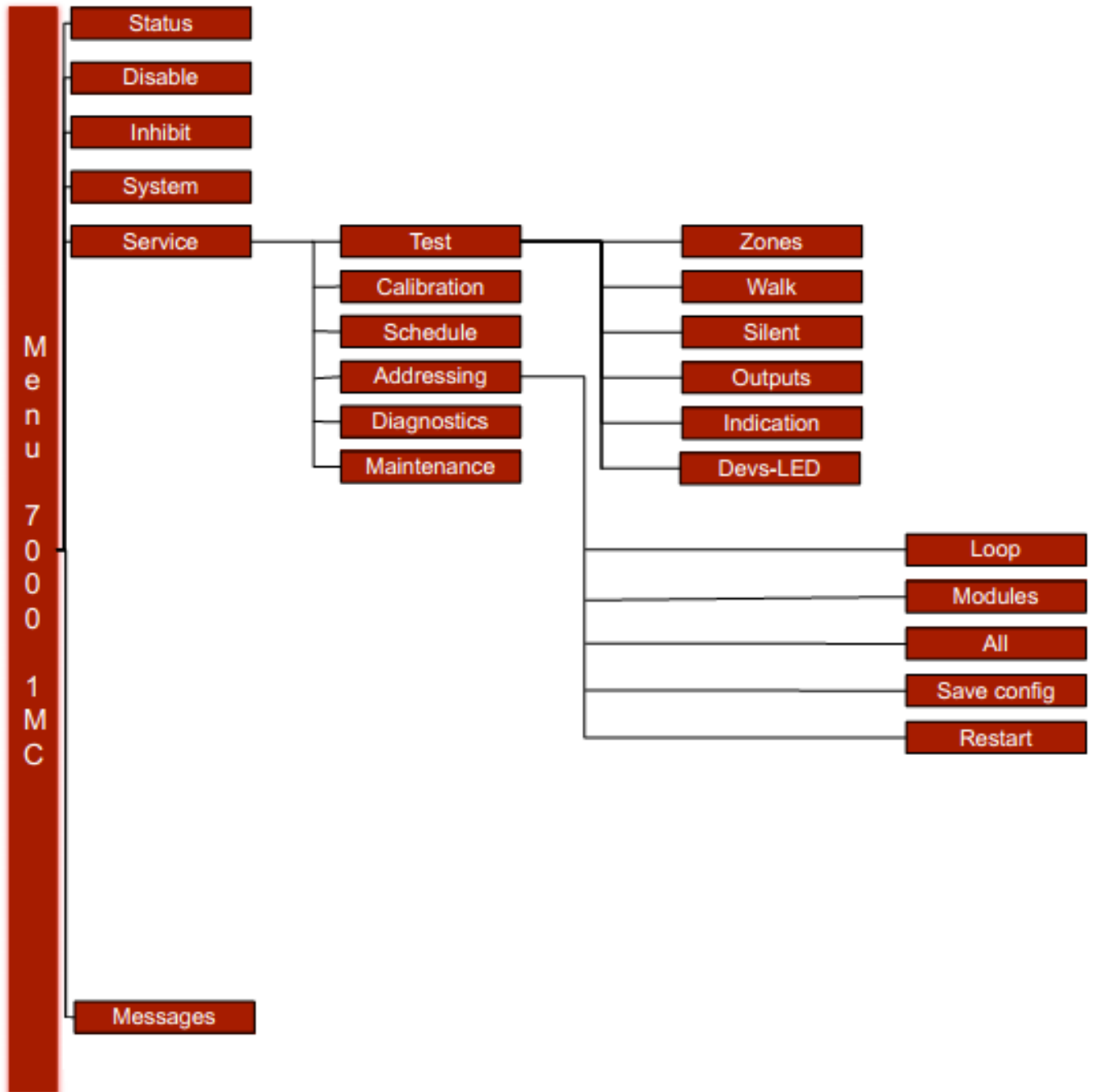

5. SETUP MANUAL 7000-1MC

Already configured hardware loop/Conventional lines and BIO modules must be connected to the Base-1Loop controller 7000-1MC and DIN8CL module. The configuration process of 7000-1MC panel starts with addressing all connected modules and peripheral loop devices. The result after this step is generation of XML file which shall be edited with PC based 7000-1MC Configurator.

5.1. Generating configuration file by panel 7000-1MC system

```
7000-1MC APP R.1.0 Jul 20 2021 11:22:00  
Power test done  
Fri 23-07-21 11:22:00
```

```
7000-1MC APP R.1.0 Jul 20 2021 11:22:00  
PSU:150W M0:BIO M1:BIO M2:BIO M3:BIO  
M4:DCL M5:DCL  
Fri 23-07-21 11:22:00
```

Power the fire panel AC ~220V and DC (battery) - 24V. After panel has started, go to menu:

```
UniPOS LTD  
7000-1MC System  
[Inactive System]  
Fri 23-07-21 11:12:00
```

5.1.1 Service / Addressing / All

– Default password F1F1F2F2 the display visualized “**Auto Configuring All**”, procedure of addressing will make partial addressing of all devices as Fire devices, Conventional lines, and BIO devices.

```
11:22 [Service/Addressing/All]  
Enter password:****
```

```
11:22 [Service/Addressing/All]  
  
F1:Start
```

```
11:22 [Service/Addressing/All]
      Auto Configuring all...
                        F3:Abort
```

```
11:22 [Service/Addressing/All]
LD:10 CL:16 BD:21
      Configuration generated
```

When the process of addressing is completed on display will visualize the count of Loop Devices (**LD: 10**), Count of Conventional lines (**CL: 16**) and count of BIO devices (**BD: 21**)

NOTE: If addressing failed, please check loop and/or devices connectivity; check for missing devices.

The generated configuration needs to be saved **Service / Addressing / Save Config.**

Press  to save it.

```
11:22 [Service/Addressing/Save config]
                        F1:Save Config
```

5.1.2 Service / Addressing / Auto-Config.

System 7000-1MS has the ability to create an automatic configuration. After the Automatic Configuration is completed, it is saved and then the system is restarted. It starts with the configuration already done.

The performed Auto Configuration arranges the found addressable devices on the loop in Detection Zones, the number of these zones depending on the number of detected devices in the address loop. One Detection Zone contains 32 address devices.

All detected Address Sirens are placed in one Alarm Zone and all Detection Zones trigger that Alarm Zone. Only their output is configured as FAD - Alarm Zone, which is the same as the Address sirens.

Programming Manual fire detectors, their activation is not a priority. (for more information see page 23 of the UniConfig Programming Guide).

Auto Configuration of the DIN8CL Conventional Line Module - each line is programmed as a Detection Zone whose number is consecutive to those in the address circuit. Activate the already created Alarm Zone.

Auto Configuration of the BIO module - only:

- Controllable Output 1 BD3 (terminals 7-8) as FBRE. (Fire exit)
- Controllable Output 2 BD4 (terminals 9-10) as FWRE (Fault output)
- User Exit BD7 - potential exit, activated in case of fire.

Auto-Configuration steps:

```
11:12 [Service/Addressing]
All
Auto-Config
Save Config
```

Choose menu "Auto-Config" - default password F1F1F2F2.

```
11:12 [Service/Addressing/Auto-Config]

F1: Start
```

Press F1 – to start the function Auto-Config

```
11:12 [Service/Addressing/Auto-Config]
      Auto-Configuring system...
                                     F3:Abort
```

```
11:12 [Service/Addressing/Auto-Config]
      LD:42 CL:8 BD:3 DZ:11 AZ:1 PZ:0
      Configuration generated
```

After completing the Auto-Configuration process, information about the detected devices, the created DZ, AZ and PZ are displayed.

The next step is to save the Auto-Configuration made from the menu: "Save Config."

```
11:12 [Service/Addressing]
      All
      Auto-Config
      Save Config
```

```
11:12 [Service/Addressing/Save Config]
                                     F1:Save Config
```

To start the configuration, the panel must be restarted.

UniPOS EOOD - It is recommended to configure the Automatic Configuration with the programming application WinUniConfig in accordance with the fire project of the site.

5.1.3 Service / Maintenance

Place mini-USB cable in the panel's mini-USB port and go to menu - **Service / Maintenance** – (default pass F1F1F2F2) panel will entered in Maintenance mode, by WinUniConfig download generated configuration file.

5.2 Basic programming of 7000-1MC-config.xml by WinUni-Config tool

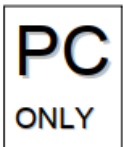

The configuration tool needs access level 3. Placed and turned user key entered valid password (default pass F1F1F2F2) at menu **Service/Maintenance**. Connect PC with Panel 7000-1MC through mini-USB cable.

The file configuration must be downloaded and opened with windows application WinUniConfig.exe. Once opened it will display the panel configuration as:

- Loop devices configuration.
- BIO devices configuration.
- DIN8CL configuration

5.2.1 Creation of D, A and P zones

Use “Panel” icon to create:

5.2.1.1 Creation of Detection zones (D zones)

– containing collection of points (automatic fire detectors, manual call points, Inputs) group together.

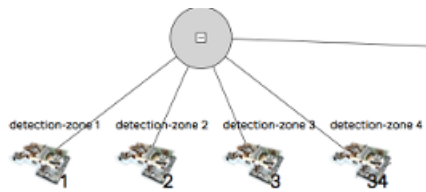

5.2.1.2 Creation of Alarm zones (A zones)

– contain and control fire alarm devices of the composition of Loops and BIO modules.

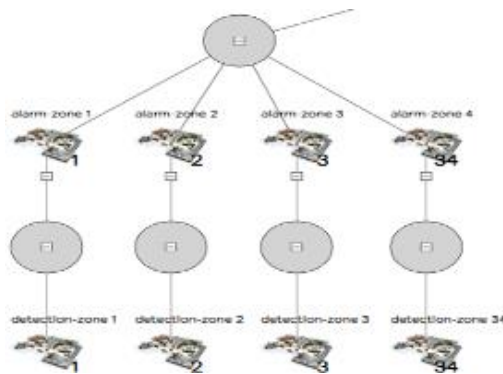

5.2.1.3 Creation of Protection zones (P zones)

– contained and control of outputs of the composition of Loops (Outputs of I/O modules) and Relay and monitored Outputs of BIO modules;



5.2.1.4 Loop device configuration

SMOKE-DETECTOR

device-number:

device-label:

device-id:

device-blink:

device-branch:

smoke-sensitivity:

detection-zone:

ri-disabled:

attached-sounder:

alarm-zone:

SOUNDER-DEVICE

device-number:

device-label:

device-id:

device-blink:

device-branch:

alarm-zone:

INPUT-OUTPUT

device-number:

device-label:

device-id:

device-blink:

device-branch:

external-powered:

control-output:

default-on:

initial-delay:

pulse-length:

pulse-pause:

output-fad:

alarm-zone:

output-fpe:

protection-zone:

general-output:

input-fire:

detection-zone:

input-fault:

input-general:

input-pattern:

input-message:

Note: All loop and BIO devices shall be distributed to D, A and P zones

5.2.2 Creation of BIO module devices

– BIO devices: please refer to page 5, BIO devices options.

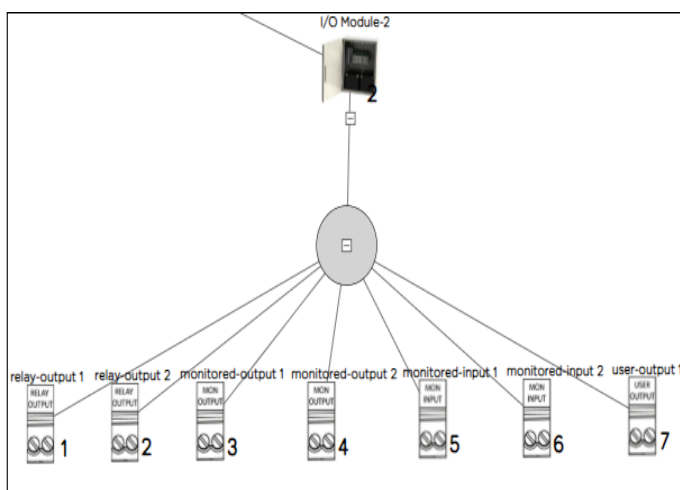

MONITORED-OUTPUT

device-number:

device-label:

output-feature:

output-fad:

alarm-zone:

output-fpe:

protection-zone:

output-fbre:

output-fwre:

output-common:

default-on:

Detection zone – can contain one or more Smoke, Heat, Combine detectors, Manual Call Points, Inputs of I/O's, and BIO modules.

Alarm zone – can contain Sounders, Outputs of I/O and BIO devices set as Fire Alarm Devices (FAD).

Protection zone – can contain Outputs of I/O and BIO devices set as Fire Protection Equipment (FPE).

5.2.3 Sounder Defaults

– Sound Type needs to be configured.



SOUNDER-DEFAULTS

sounder-alarm:

sounder-warning:

OK CANCEL

Sounder types:

- **Slow whoop** – melody frequency 500-1200Hz, sound pressure >85dB
- **US Temporal** – melody frequency 970Hz, sound pressure >85dB

5.2.4 Day-Night settings:

- Weekdays
- Day delay
- Night delay
- Day-start
- Day-length

DAY-NIGHT

day-indicator:

day-delay:

night-delay:

week-days: M T W T F S S

day-start:

day-length:

5.2.5 Sensor Defaults

– Sensor sensitivity in day mode needs to be configured, else set configuration of each one sensor in the loop.

SENSOR-DEFAULTS

day-smoke:

day-heat:

day-logic:

NIGHT-DEFAULTS

night-smoke:

night-heat:

night-logic:

5.2.6 mode:

Standard

- Fire panel is in standard mode when “Day-night settings” are not activated/selected.
- There is no automatic change detectors sensitivity in certain times.
- Standard mode requires all Loop devices to be configured.

5.2.7 DIN8CL module:

The screenshot shows a configuration window titled "DCL-LINE". It contains several input fields and a dropdown menu, each with a label and a value:

Field Label	Value
line-number:	1
line-label:	DCL 1
number-checks:	1
sensor-removal:	no
line-short:	95
line-fire2:	36
line-fire1:	24
line-open:	6
detection-zone:	10

At the bottom right of the window, there are two buttons: "OK" and "CANCEL".

The Conventional lines settings need to be configured.

5.3 Upload configuration file 7000-1MC-config.xml

5.3.1 Upload 7000-1MC-config.xml:

Service / Maintenance (default pass F1F1F2F2) connect mini-USB cable with computer and configuration file with WinUniConfig software upload it in 7000-1MC panel. Go to button "Save As" and select option "Write Config".

5.3.2 Panel software power off or Restart:

System / Stop / Power off - (default pass F1F1F2F2) – press  button to confirm.

```
11:22 [System/Stop]
Poweroff
Restart
```

```
11:22 [System/Stop/Poweroff]

F1:Confirm
```

Select “**Restart**” - Restart the panel by reset the power supplies: AC and DC battery.

After the initialization the panel will start with the new configuration.

6. Coincidence modes – dependency on more than one alarm signal:

6.1 CI-Mode A

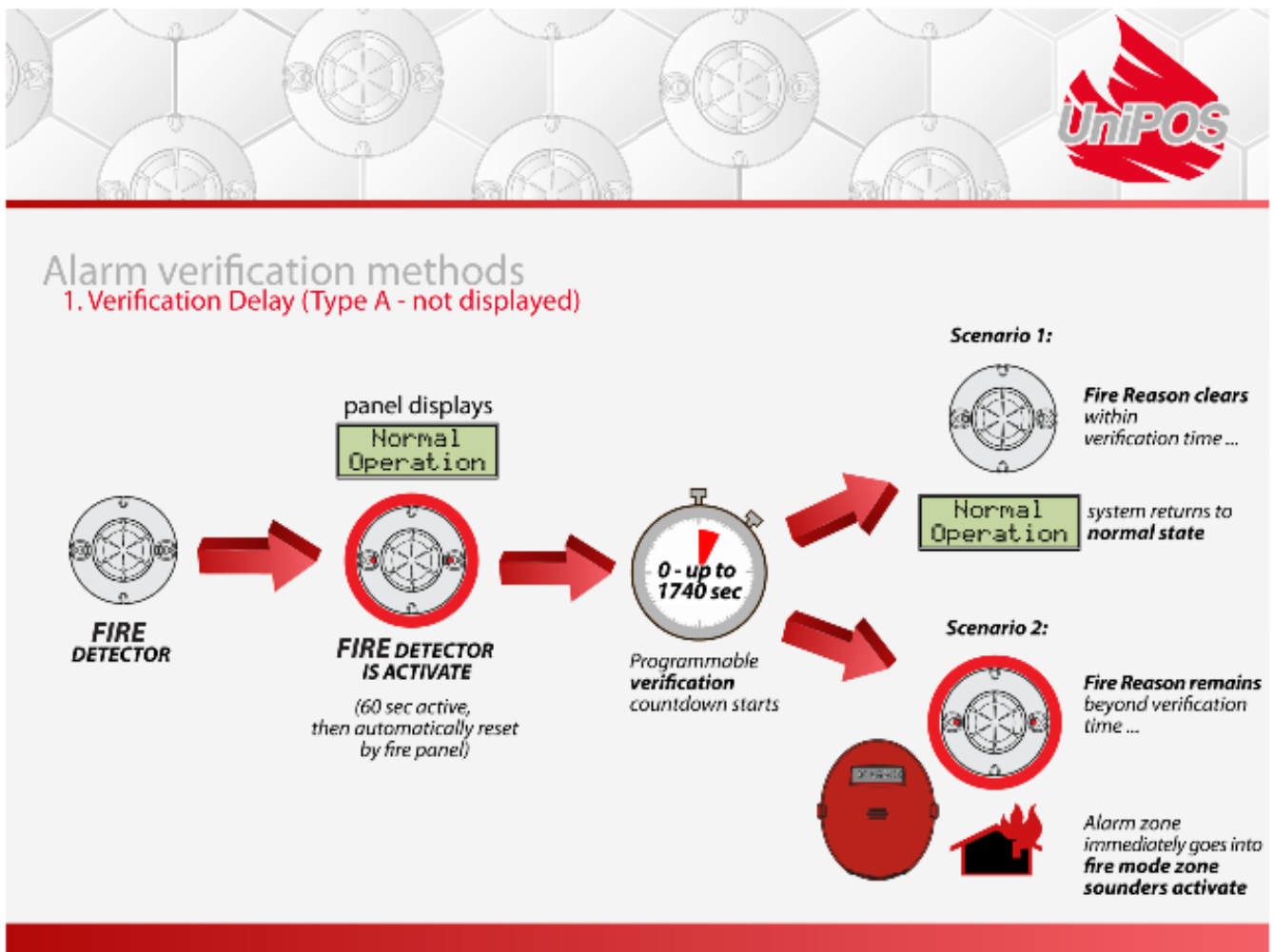

Feature complies with EN54-Part 2, Type A coincidence mode. Single fire detector activation detects fire. It is analyzed at 60 sec. Then FD resets automatically by the control panel. Whether the cause of fire has disappeared or confirmed, if there is a fire confirmation after the time expiration (up to 1740 sec), it is stated in scenario 2. The Fire Alarm Devices are activated with no delay.

This scenario is presented to infiltrate fake device's activation without operator intervention – i.e., there is no need for a panel indication on the first fire detector activation, the second activation the control panel goes into Fire mode - scenario 2, if there isn't a second activation the panel stays in Normal Operation Scenario 1.

6.2 CI-Mode B

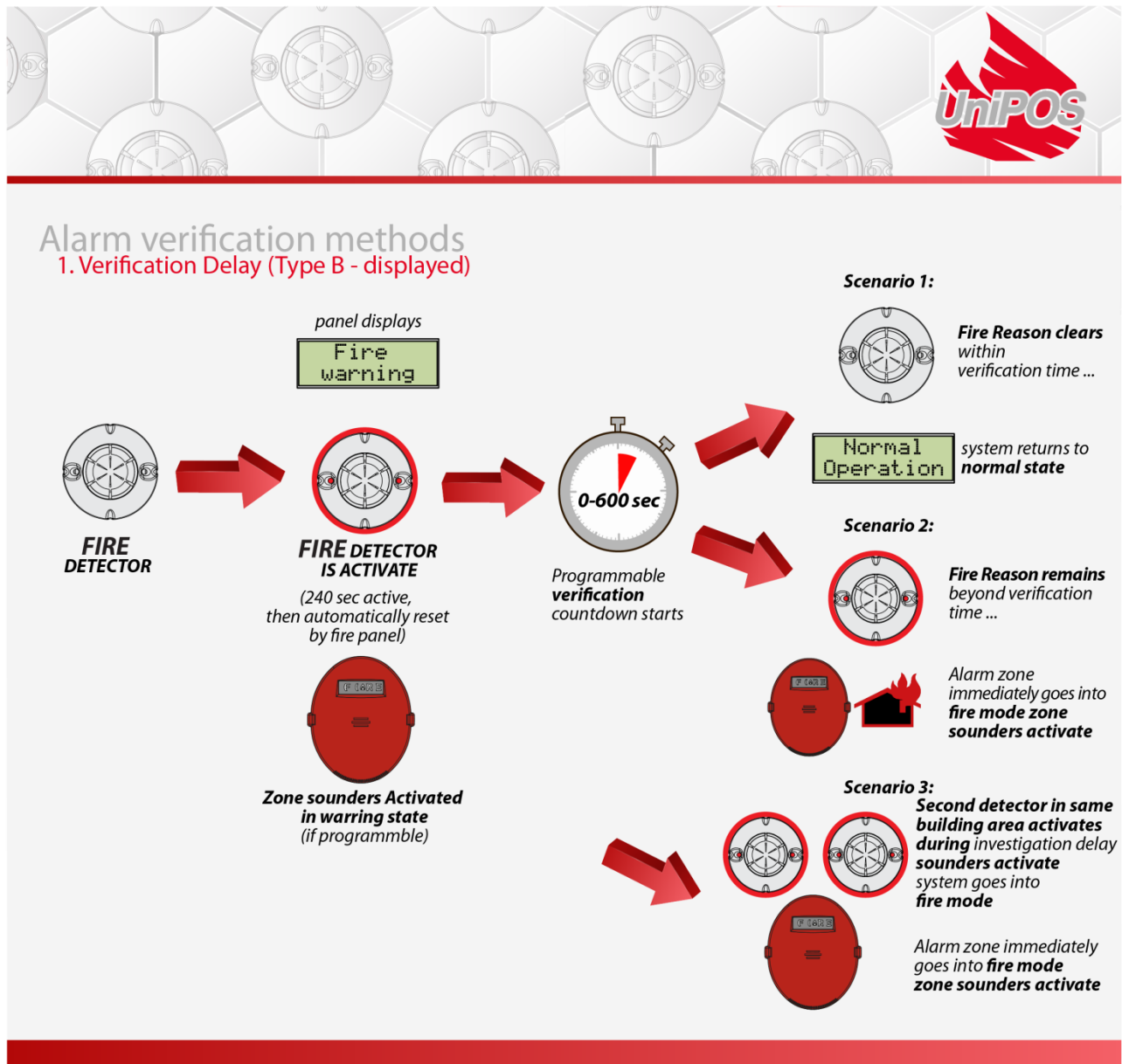

Feature complies with EN54-Part2, Type B coincidence mode. One device or two devices from the same or different area (but guarding the same room) when confirming a fire. The Control panel is in a state of Fire warning, Fire Device - FD will stay activated for 240 sec, before fire panel reset it automatically, then starts the programmable fire-timeout (0 up to 300 sec.) whether we have a fire from the same FD or from another FD in the same/guarding area and if there is a confirmation of the fire within the time, it immediately goes to scenario 2 (scenario 3 respectively). The Fire Alarm Devices are activated with no delay. This CI-mode B is designed to filter false fire alarms without operator intervention. The information of the control display gives sufficient information about the fire event.

6.3 CI-Mode C

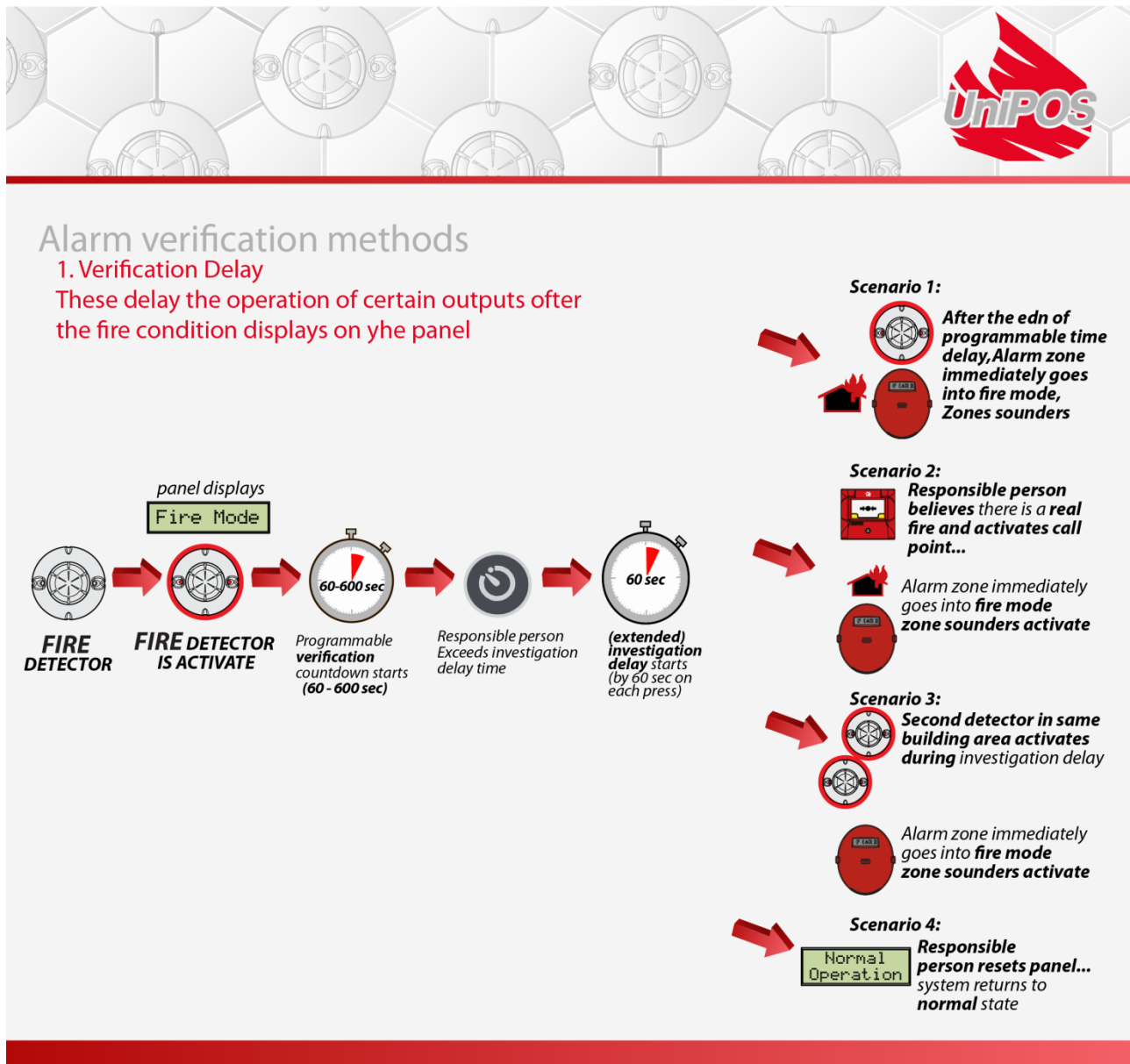

Feature complies with EN54-Part2, Type C coincidence mode. Two devices from the same or different area (but guarding the same room) when confirming a fire. Fire activation of first detector puts the Control panel in Fire mode operator's intervention is expecting. If missing intervention and time delay is up the fire alarm devices are activated. When there is an activation of another detector, fire alarm devices are activated with no delay. If there is an operator's intervention the time delay is exceeded by 60 sec.



Alarm verification methods

1. Verification Delay CI mode C

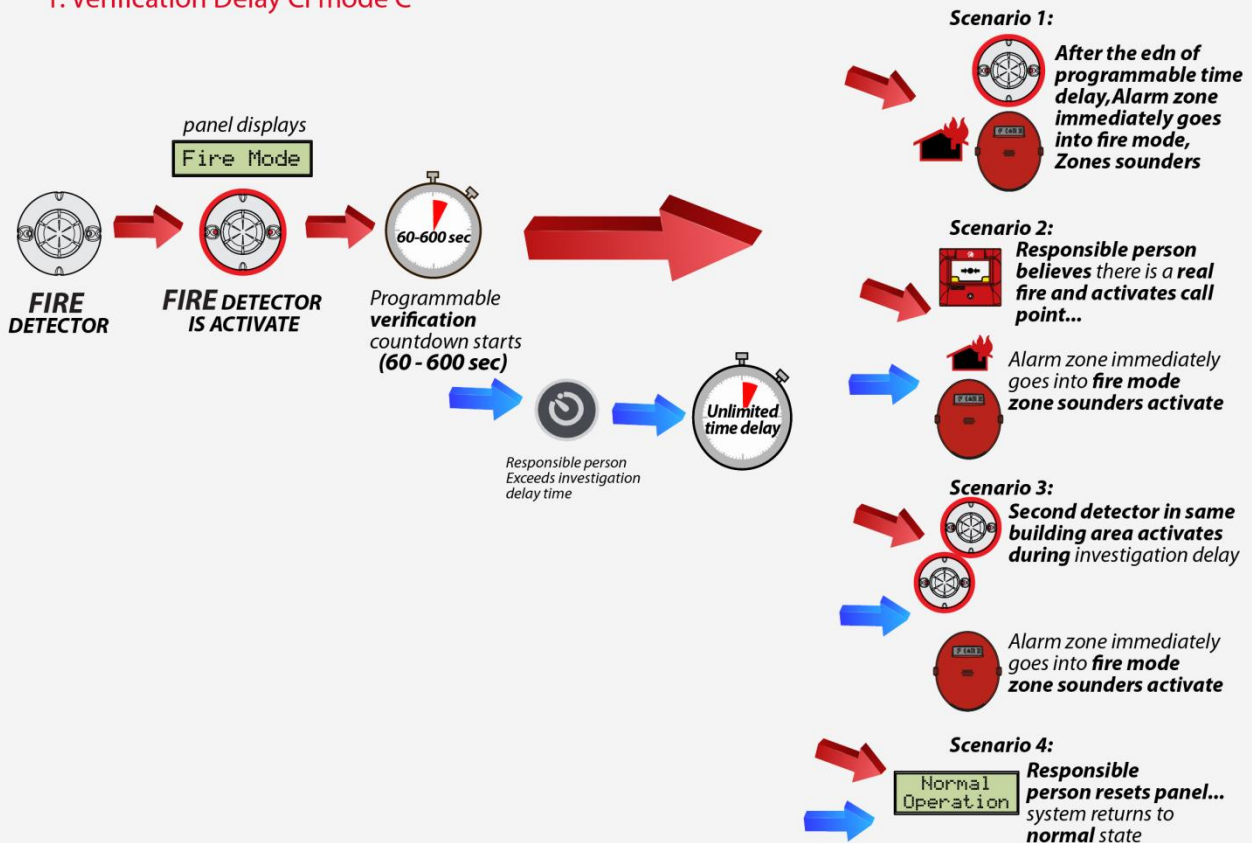

Coincidence mode C has the option to set the 0-600's sec. programmable time delay to unlimited. Fire alarm devices will be activated after end of fire-time delay (scenario 1), by operator's intervention (Scenario 2) or there is activation of another device (Scenario 3).

Information for configured delays can be acquired on access level 2 from **System** → **Config** - >**D-zones** (T=xxx) in seconds.

PC
ONLY

```
10:11 DZ4 (M0-L1) (1)
detection-zone 4
AZ1 PZ0 CI:B(T=60) DZ4 DZ6
LD 03 SmokeDetector
```

Configuration of all Dependency modes can be set up over configuration tool Win-UniConfig.

7. 7000-1MC Operational modes

7.1 Normal operation

7.1.1 Description

The Fire Control Panel is in Normal Operation when there are not any others active modes.

7.1.2 Indication

FIRE -	F1	F2	F3	F4	FPE - 1	- FBRE FIRE
FAULT -					FWRE ACTIVATION - 2	- FBRE FAULT
SYSTEM FAULT -					FWRE FAULT - 3	- DISABLES
PSU FAULT -					DAY/NIGHT - 4	- SOUNDERS
N/A -					5	- INT. BUZZER SILENCED
TEST -	SILENCE SOUNDERS	MUTE INT BUZZER	INVESTIGATE TIME	RESET FIRE	6	- SOUNDERS SILENCED
DELAY OUTS -					7	- POWER ON

LED and Sound indication

In Condition Normal Operation are illuminated the green LED indicator “Power supply”. If yellow LED indicator **4** is ON, “Day mode active” is set.



4 - Night mode/Standard mode activated (symbol is not illuminated)

4 - Day mode activated (symbol is illuminated in yellow)

Text indication

The display shows the following information:

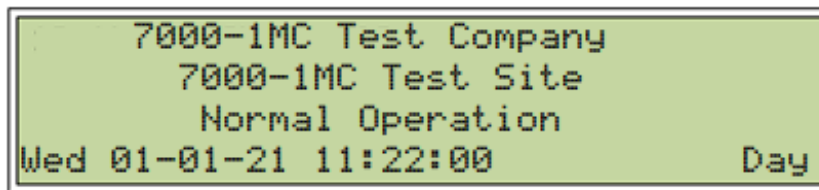

- **Name of the company** (sign can be changed by user by Configurator)
- **Name of the Site** (sign can be changed by user by Configurator)
- **Condition of the control panel**
- **Weekday**
- **Current date**
- **Real time**
- **Day / Night or Standard mode** – (programmable by Configurator)

Types of programmable sensitivity of detector at Day/Night or Standard mode:

- **Heat Detector Sensitivities** – *A2R; A2S*
- **Smoke Detector Sensitivities** – *Low; Medium; High*
- **Combined Detector Sensitivities:**
 - **Smoke part** – *Low; Medium; High*
 - **Heat part** – *A2R; A2S*
 - **Sensor logic** – *only Heat; only Smoke; Heat or Smoke; Heat and Smoke.*

Standard mode: Fire detectors must be set with individual settings.

The only active button at this condition is  (“Menu”). The button is accessible for all access levels. In Normal Operation the Fire Alarm Devices and Alarm zones

can be forced to activate (Evacuation) by pressing twice button  at Access level 2. In this case the display shows text

“**Evacuation!!!**”

(For more information refer section **Error! Reference source not found.**)

 Pressing button will stop it.

7.2 Fire mode

7.2.1 Description

The Fire Control Panel enters Fire condition mode upon activation of a fire detector, fire input, network panel fire event or script triggered. Exit from this mode is only through manual operation with ensured access level 2:







Step 1 – To reset Fire press reset button.



7.2.2 Indication

LED and sound indication

In this condition are illuminated:

- With green light indicator:  (“Power supply”);
- With red light indicator:  (“Fire condition”);
- Active FAD outputs can be suppressed by pressing button:  (“Outputs”), the LED indicator is illuminated in continuous Yellow light ;
- Active panel Buzzer can be deactivated by pressing button:  (“Buzzer”), the LED indicator is illuminated in continuous yellow light.
-  Indication for activated Fire Brigade Routing Equipment (FBRE) output. Upon registering of fire event, output FBRE is activated regarding its timeout setting. Preset time for activation is with 30 second’s delay. If monitored FBRE conf. input is configured, a confirmation signal from fire alarm routing equipment shall be received for a particular time. During this time 

is blinking until its confirmation over the input.

- Led **1** (activated FPE) is illuminated in case of activated Fire Protection Equipment, if configured. This LED is general for all active FPE devices.

FPE activation confirmation input can be configured and shares same led with FPE- but in different illumination mode – if FPE Activation input is configured, activation to FPE is indicated with blinked led (activated FPE) until FPE equipment is not confirmed by FPE Activation input.

Text indication



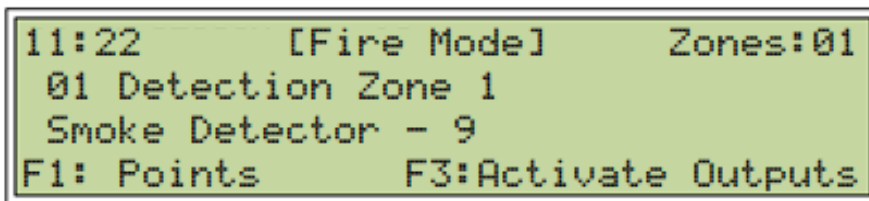

In this condition on the display is visualized









- **"01"** → number of Fire activation.
- **"Detection Zone 1"** → number and user description name of the detection zone to which the activated detector belongs.
- **"Smoke Detector – 9"** → user description name;
- **"Zones: 01"** – counter of zones in Fire.

7.2.3 Using keypad

Actions on using with buttons apply to all the areas, where the fire condition occurs.

Button	Access Level	Action	Additional Information
Button ("Outputs") 	Access level 2	Deactivation of the outputs in case of Fire condition.	Operating with the button requires access level 2 LED indicator  is illuminated if the condition suppressed outputs is active.
Button ("Buzzer") 	All	Silenced the panel buzzer.	LED indicator is  illuminated if the condition switched off sounder is active. The local sounder is activated again: - upon entering Fire condition of the Control Panel from a new zone.

<p>Button ("Inspection")</p> 	<p>All</p>	<p>Increase inspection time (time to outputs activation) with 60 seconds per press.</p>	<p> Extend delay time up to 600 sec. LED indicator is illuminated when there is active inspection time.</p>
<p>Button ("Menu")</p> 	<p>All</p>	<p>Enters condition Information and control menus.</p>	
<p>Button ("Reset")</p> 	<p>Access level 2</p>	<p>Forces the control panel to exit from Fire condition – clears all fires in all zones.</p>	
<p>Buttons ("Up" and "Down")</p> 	<p>All</p>	<p>If the fire conditions are more than one, information about each of them is displayed by means of the buttons.</p>	
<p>Button ("Exit")</p> 	<p>All</p>	<p>Leads to exit from the condition Information and control.</p>	

7.3 Fault condition





7.3.1 Description

The Fire Control Panel enters „Fault Condition” upon detecting fault in one of the modules or/and in one of the devices, registered within the system.

7.3.2 Indication



LED and Sound indication

For all fault conditions indicator  (“Fault”) is ON with flashing yellow light. Depending on the type of fault condition, the following indicators are also illuminated.

- system fault – indicator  (“System fault”) is On with continues yellow light.
- Fault of the mains power or back up batteries supply – indicator  (“Fault Power supply”) is illuminated with continues yellow light.
- Fault of Mon. Output FBRE –  Indicator is illuminated with flashing yellow light if signal from fire alarm routing equipment is not confirmed over FBRE conf. input or fault in FBRE monitored output is observed – short or open circuit.
- Fault in controllable output –  (Fault Mon. Output Fire Alarm Device - FAD) Indicator is illuminated with flashing yellow light.
- Fault in fire protection equipment transmission path – (Fault Mon. Output Fire Protection Device - FPE) Indicator is illuminated with flashing yellow light.
- Fault in an of the fire devices, the indicator of the zone to which it belongs and text message on the display.



Text Indication

The screens of faults will suppress other messages except fire events. In the occurrence of more than one fault, panel indicates them in separated flashing line. Use buttons   to view the suppressed lines. Flashing lines means unconfirmed information, to confirm it press button .

Upon registering of fault indication, output Fire Warning Routing Equipment (FWRE) is activated regarding its timeout setting. Preset time for activation is with 30 second's delay.

There is an illuminating flashing yellow indication **2** on the keypad.







```
11:12      [Fault Mode]      Total:02
(01) L-Loop
(02) P-Smoke Detector-9
```

Press button “menu” over message “P-Smoke Detector -9”

```
11:12      [Fault Mode]      Total:02
Type:Not responding
L1 D1 DZ1:DZ-1
Status:Not accepted
```

There is additional information: **L1** – Loop number; **D1** – Device position in the loop
DZ-1 – detection zone 1

7.3.3 Using keypad

Button	Access Level	Action	Additional information
Button (“Buzzer”) 	All	Switch off the panel buzzer	
Buttons (“Up and Down”) 	All	Display information about fault conditions, if more than one fault is registered.	
Button (“F1”) 	Access level 2	Confirms the new panel events.	Every new event must be pointed at with the cursor and confirmed with 
Button (“Menu”) 	All	Enters condition Information and control.	
Button * (“Reset”) 	Access level 2	Clear the pointed restored fault.	*Note: There are some fault exceptions which cannot be recovered automatically. See 7.3.4 for more details.

7.3.4 Faults list

Not responding – check device; device loop connection

Contaminated chamber – disassembly detector and clean the chamber.

Fault indicator – check device; device loop connection

ADC smoke error measured – disassembly the detector and clean the chamber.

Power supply fault – No battery connected; battery fail; AC loss.

A-side short – Check loop cable-outputs connection, first and last loop detector connections.

B-side short – Check loop cable-outputs connection, first and last loop detector connections.

Open power wire – Check loop cable connections between displayed points.

- **Between unknown points** – Check loop device connections

- **Between points** – Check loop connections between displayed points.

Low battery – check/change batteries; check power supply output - 24 V.

Fault output – check Device output connection / load

Fault FAD output – check BIO/IO device Output connection and voltage

Fault FPE output – check BIO/IO device Output connection and voltage
Fault FBRE output – check BIO/IO device Output connection and voltage
Fault FWRE output – check BIO/IO device Output connection and voltage
Fault BIO output – check BIO device User Output connection and voltage
Fault Input check BIO/IO device Input connection
Fault Fire input – check BIO/IO device's Input connection
Fault FBRE input – check BIO/IO device's Input connection
Fault FWRE input – check BIO/IO device Input connection
Fault FPE-F input – check BIO/IO device's Input connection
Fault FPE-A input – check BIO/IO device's input connection
Fault BIO input – check BIO/IO device's Input connection
FBRE send not confirmed – Input “FBRE confirmed” has not activated by the preset time, check BIO device connection.
FWRE send not confirmed – Input “FWRE confirmed” has not activated by the pre-set time, check BIO device connection.
Fault FPE – check BIO/IO device's wire connection
LED board – Check LED Board cable connection.
Comm. Error – check RS 485 cable connection

Types of BIO faults:

- **short** – short circuit between BIO device connectors
- **open** – Open BIO device connectors
- **overload** – Overload BIO device Output

BIO device alerts:

- **Alert creep-short BIO device** – check BIO device's wires connection
- **Alert creep-open BIO device** – check BIO device's wires connection

PSU fault types:

- **Mains 220 V** – check connection to 220V, check FUSE 4A
- **Loss of battery charger** – this fault appears when the battery charger fault is detected. Measure voltage on battery terminals.
- **User Out** – check user output connection for short circuit.
- **Battery Low** – check/change batteries, check power supply output 24 V
- **No Battery** – check battery; check battery connection
- **Battery Hot** – check/change batteries, check power supply output 24 V
- **Earth** – check Earth wire connection
- **Reset PSU** – restart panel
- **Comm. Error** – check PSU connection; restart panel

Module fault events:

- **Fault module comm. error** – check module DIN rail connection; restart panel
- **Fault module watchdog reset** – module reset by watchdog function
- **Fault module software reset** – module reset by software
- **Fault module mem. check fault** – memory fault; restart panel
- **Fault module general fault** – restart panel
- **Fault module 24 V** – restart panel.
- **Fault module 33 V** – restart panel.
- **Fault loop short detected** – check loop wire connection
- **Fault loop A-short appeared** – check loop wire connection side A
- **Fault loop B-short appeared** – check loop wire connection side B
- **Fault loop A-short power off** – check loop wire connection side A
- **Fault loop B-short power off** – check loop wire connection side B
- **Fault loop total-short power off** – loop detects appearing of short on both sides. Check loop installation.
- **Fault loop short minus-ground power off** – check loop minus wire connection
- **Fault loop short plus-28 V power off** – connection between loop plus wire and 28V potential. Check wire connection of BIO devices to conventional sounders and another monitored device
- **Fault loop param. Degrade** – check loop device wire connection
- **Fault loop open plus** – check power wire;
- **Fault loop open minus** – check minus wire
- **Fault loop open both** – loop cable is interrupted on plus and minus wire

Device fault events:

- **Fault device missing** – check device present/connection.
- **Fault isolator on** – Check loop wire connection to the displayed device
- **Fault indicator** – check device; check device connection.
- **Fault dirty sensor** – disassembly the detector and clean the chamber
- **Fault input short** – check device 7203M input connection
- **Fault input open** – check device 7203M input connection
- **Fault output short** – check device 7203M output connection
- **Fault output open** – check device 7203M output connection
- **Fault power isolator** – check device connection
- **Fault measure error** – disassembly the detector and clean the chamber
- **Fault power supply** – Check external power supply missing

BIO device fault events

- **Fault short BIO device** – check BIO device wire connection

- **Fault open BIO device** – check BIO device wire connection
- **Fault overload BIO device** – check BIO device Load connected
- **Alert creep-short BIO device** – check BIO device wire connection
- **Alert creep-open BIO device** – check BIO device wire connection
- **FPE fault BIO device input** – check BIO device wire connection
- **External fault BIO device input** – check external device connection

DIN8CL fault events

- **Fault Short DCL** – Check DCL line for Short circuit
- **Fault Open DCL** – Check DCL line for missing Device
- **Fault Overload DCL** – Too many devices on the line

SYSTEM FAULT – fault is indicated by separate light emitting indicator - “System Fault”, light emitting indicator “General Fault” and active buzzer. “System Fault” will remain until action taken - restart of the panel at level access 3 - removed main and battery power supply. If after the restart “System Fault” remains - maintenance service is required.

8. Disable condition

8.1 Description

The Fire Control Panel enters Disable condition after manual operation of disabling an element of the Fire alarm system – fire detector, Fire Input, Fire Output or periphery or detection zone. Disabled element does not produce any signals for fire or fault until it's re-enabled.

Disabled components are kept unchanged in case of power reset of the panel.

Operations of check for disabling is in menu “Status → Disable”

Operations for disabling will be performed in menu “System → Disable” at access level 2.

8.2 Indication

LED and sound indication

In presence of disabled component, indicator  is continuously on. The condition has no sound indication.

Text Indication

The entered disabled components can be reviewed from condition Status:

- Upon selecting “Status → Disable” the entered disabled components can be reviewed.

```
11:12 [Status/Disables]
All
Zones
Sensors
Inputs
Outputs
Others
```

General information about the number of the disabled fire devices is provided in menus:

“All”, “Zones”, “Sensors”, “Inputs”, “Outputs” and “Others”.

- Menu “All” – displays information for all disables.
- Menu “Zones” – displays information only for disabled zones.
- Menu “Sensors” – displays information only for disabled addressable fire detectors.
- Menu “Inputs” – display information only for disabled inputs (monitored inputs and addressable input devices).
- Menu “Outputs” – display information only for disabled outputs (monitored outputs and addressable output devices).
- Menu “Others” – display information only for disabled periphery as printer, repeaters.

```
11:22 [Status/Disables/All] Disab.:01
(01) detection-zone 1
```



“(01)” → Number of the detection zone

“Detection-zone 1” → User label of the detection zone



“Disab.: 01” → Counter of the disablement

8.3 Disable Procedure

```
11:12 [Disable]
Zone
Sensors
Inputs
Outputs->
Others
```

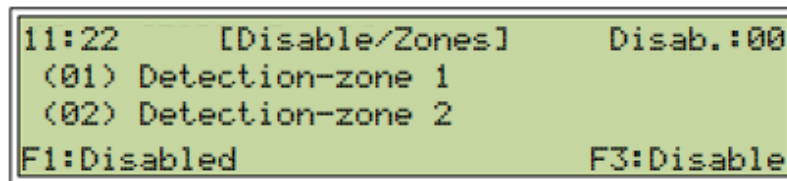
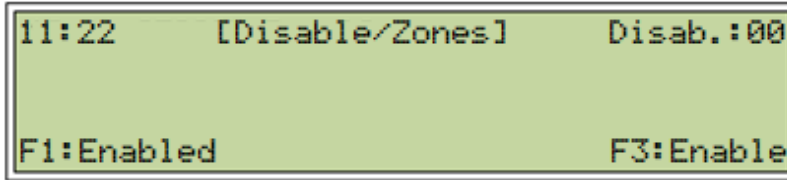

Select the element to disable, use the buttons   to view all elements from the list menu. To select “Zone” press button  if there is any disablement zone





will be visualized if there are none, press button  to get zone's list, to disable the selected zone use button . To return to the previous menu with the list of disabled devices press .



8.4 Using keypad

Button	Access Level	Action	Additional information
Button (“Menu”) 	All	Enters condition Information and control.	
Buttons (“Up and Down”)  	All	Display information about disabled zones, if more than one is registered.	

Button ("F1") 	Access level 2	Displays zones list.	
Button ("F3") 	Access level 2	Displays disabled zones list.	

9. Inhibit condition

9.1 Description

The Fire Control Panel enters Inhibition Mode after manual operation of Inhibit an element of the Fire alarm system – fire detector, Fire Input, Fire Output, periphery, or detection zone. The inhibited element does not produce signals for fire but still sends signals for faults.

Status of all Inhibit components is kept unchanged in case of power reset of the panel. Operations of check for disabling is in menu "Status → Inhibit"

```

11:12      [Inhibit/Zones]      Inhib.:00
F1:Allowed                                F3:Allow
    
```

Operations for Inhibit will be performed in menu "System - Inhibit" at access level 2

9.2 Indication

LED and sound indication

In the presence of inhibit component, indicator  is continuously ON. The condition has no sound indication.

Text Indication

The entered inhibited components can be reviewed from condition "Status":

- Upon selecting "Status → Inhibit" the entered inhibited components can be reviewed.

```
11:12      [Status/Inhibit]
All
Zones
Sensors
Inputs
Outputs
Others
```

General information about the number of the Inhibit fire devices is provided in menus:

“**All**”, “**Zones**”, “**Sensors**”, “**Inputs**”, “**Outputs**” and “**Others**”.

- Menu “**All**” – displays information for all inhibits.
- Menu “**Zones**” – displays information only for inhibited zones.
- Menu “**Sensors**” – displays information only for Inhibited addressable fire detectors.
- Menu “**Inputs**” – display information only for inhibited inputs (monitored inputs and addressable input devices).
- Menu “**Outputs**” – display information only for inhibited outputs (monitored outputs and addressable output devices).
- Menu “**Others**” – display information only for inhibited alarm or periphery zone

```
11:22 [Status/Inhibit/All]  Inhib:01
(01) Smoke Detector-1
```



“(01)” → Number of the detection zone

“**Smoke Detector – 1**” → User label of the Fire Detector

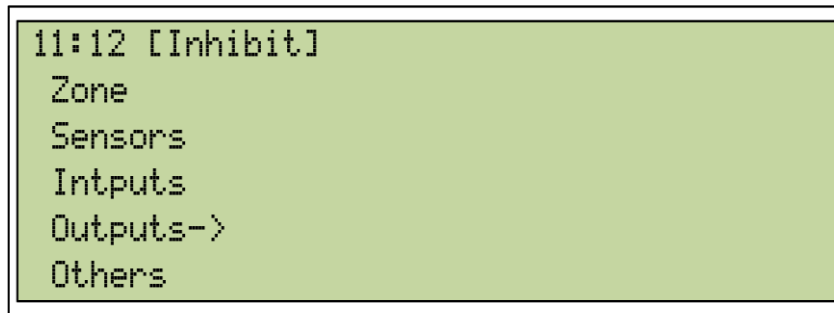

“**Inhib:01**” → Counter of the inhibited devices.

9.3 Inhibit Procedure



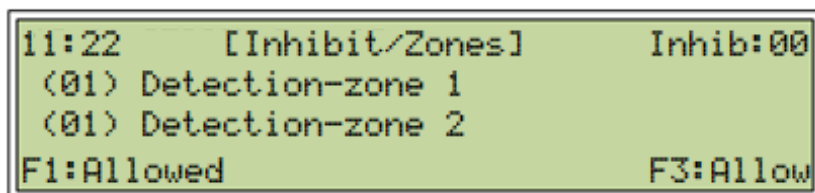



Select the element to inhibit, use the buttons   to view all elements from the list menu. To select “Zone” press button  if there is any inhibited zone



will be visualized, if there are none, press button  to get zone's list, to inhibit the selected zone use button . To return in the previous menu with the list of inhibited devices press .



9.4 Using Keypad

Button	Access Level	Action	Additional information
Button (“Menu”) 	All	Enters condition Information and control.	
Buttons (“Up and Down”) 	All	Display information about inhibited zones, if more than one is registered.	
Button (“F1”) 	Access level 2	Displays list of the zones.	
Button (“F3”) 	Access level 2	Displays list of the inhibited zones.	

10. Test condition

10.1 Description

The Fire Control Panel enters at “Test “condition by a specific zone after manual operation for setting up a zone in test. The condition can be made from control menu in access level 2.

```

11:22      [Status/Test]      T-zones:01
(01) Detection-zone 1

F2:Test fires
    
```

10.2 Indication

LED and Sound indication

The condition has no sound indication. LED **T** and the led indicator of the corresponding zone at zone indication board in test are illuminated.

Text Indication

The entered devices in “Test” can be reviewed in menu “Status → Test”

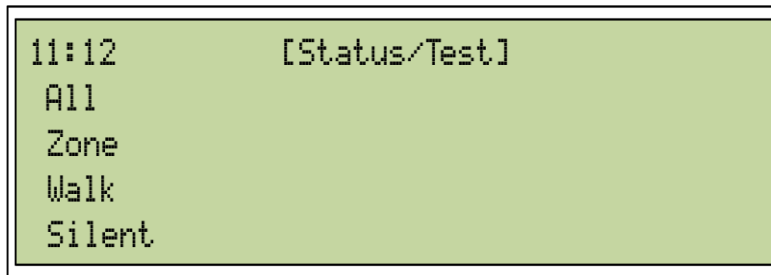

```
11:12      [Status/Test]
All
Zone
Walk
Silent
```

General information about the number of the devices in Test is provided in menus: “All”, “Zone”, “Walk”, “Silent”.

- Menu “All” – displays information for all “Tests”.
- Menu “Zone” – displays information for zones in “Test”.
- Menu “Walk” – displays information for zones in “Walk Test”.
- Menu “Silent” – display information for zones in “Silent Test”.

10.3 Procedure of Test

Menu “Test” is in menu **Service** → **Test** and contains: “Zone”, “Walk Test”, “Silent-WT”, “Outputs”, “Indication”, “LED” and “Printer”.

- “Zone Test” – set the selected zone in test – activated sensor activates zone sounder for 10 sec, there is Test indication on the LED board.

- “Walk Test” – set the selected zone in “Walk Test” - activated sensor activates Zone sounder for 10 sec, there are Test and Fire indication on the LED board.



- “Silent-WT” - set the selected zone in “Test”- activated sensor, activates Fire indication on the LED board.

- “Output Test” – Activates for 10 sec the selected Output.



- “Indication Test” – Activates BUI LEDs and Buzzer and zone indication board LEDs.

- “Dev’s LED” – Activates device LEDs or remote indicator if attached.

```
11:12 [Service/Test]
Zone
WalkTest
Silent-WT
Outputs
Indication
```

Use buttons   to view all Test types in the list menu. To select test type, point it with the cursor “Zone” and press button 

```
11:22 [Service/Test/Zones] T-zones:00
(01) Detection-zone 1
(02) Detection-zone 2
F1:TestZones F2:Fast Scroll F3:Start
```

Zone list is visualized, to select zone set in “Test” use button . To return to the previous menu with the list of detection zones presses . Pressing button will visualize the detection zones which are activated in Test condition.

```
11:22 [Service/Test/Zones] T-zones:01
(02) Detection-zone 2
F1:Detection Zone F2:Test-fires F3:Stop
```

“02” → Number of the detection zone in “Test”





“Detection-zone 2” → User label of the Detection zone in “Test”

“T-zones:01” → Counter of the zones in “Test”



T – Test mode activated

10.4 Using keyboard

Buttons	Access Level	Action	Additional information
Button (“Menu”) 	All	Enters to condition Information and control.	
Buttons (“Up and Down”) 	All	Displays information about “Test” condition, if more than one is registered.	
Button (“F1”) 	Access level 2	Displays list of the devices in “Test” condition.	
Button (“F3”) 	Access level 2	Displays the list of the devices in “Test”.	

11. Evacuation

11.1 Description

In „Normal Operation” by pressing twice button  the Fire Alarm outputs (FAD) of the control panel and all Alarm zones, can be activated simultaneously “**Evacuation**” access level is 2 required.

Pressing Button  will stop it.

12. Event log

To check events, go to menu **System** → **Events**. The menu provides information for all events up to 4095, saved in energy independent memory of the fire control panel

The following events are registered in the control panel:

All – list of all events written in the panel memory

Fires - filtered from memory list of all fire events

Faults -filtered from memory list of all fault’s events

Disablement - filtered from memory list of all disablement events

Inhibit - filtered from memory list of all inhibit events

Test - filtered from memory list of all test events

Menu “**All**”- containing all events.

By filtering the events are made the rest of the menus. Each of the menus contains only information for **Fires, Faults, Disablement, Inhibits, Tests**.

Menu **Log** – contains programmer information, history of starting and processing the programmer code.

Event logs can be deleted by operator on access level 3 ensured by password follow-

ing menu **System / Setup / Archive** and button  .

13. Status

13.1 Fires – list of active fires

13.2 Faults – list of active faults

13.3 Disablement

- **All** – list of active disablement events
- **Zones** – list of active disablement zones
- **Sensors** – list of active disablement sensors
- **Inputs** – list of active disablement inputs
- **Outputs** – list of active disablement outputs

13.4 Inhibit

- **All** – list of active inhibit events
- **Zones** – list of active inhibit zones
- **Sensors** – list of active inhibit sensors
- **Inputs** – list of active inhibit inputs
- **Outputs** – list of active inhibit outputs
- **Others** –

13.5 Tests

- **All** – list of active tests
- **Zones** – list of active zones in test
- **Sensors** – list of active sensors in test
- **Inputs** – list of active inputs in test

- **Outputs** – list of active outputs in test
- **Others** –

13.6 Components

- **Loops** – Loop current; Plus resistance; Minus loop resistance;
- **Modules** – software and hardware version of DIN connected modules
- **PSU** – PSU type /status; battery test
- **Other:**
 - **LAN** – IP configuration
 - **Fire counter** – counter of passed fires

14. Menu Disable

```
11:12 [Disable]
Zones
Sensors
Inputs
Outputs ->
Others
```

Zones – first screen shows list of already disabled zones (If there are any disabled).

```
11:22 [Disable/Zones] Disab:00
F1:Enabled F3:Enable
```

By pressing **F1** “Enabled” will display list of disabled zones with their user labels.

```
11:22 [Disable/Zones] Disab:00
001 Detection zone 1
F1:Disabled F3:Disable
```

Press **F3** to disable the selected zone. Press **F1** to see disabled zone list.

Sensors – First screen shows list Disabled Sensors (If there are any disabled).

```
11:12      [Disable Sensors]      Disab.:00
F1:Enabled                                     F3:Enable
```

By pressing **F1** “Enabled” will display list of sensors with their user labels.

```
11:12      [Disable/Sensors]      Disab.:00
(01) Floor 1 room 1
(01) Floor 1 MCP
F1:Disabled                                     F3:Disable
```

Press **F3** to disable the selected sensor. Press **F1** to see disabled sensor list.

Inputs - First screen shows list Disabled Inputs (If there are any disabled).

```
11:12      [Disable/Inputs]      Disab.:00
F1:Enabled                                     F3:Enable
```

By pressing **F1** “Enabled” will display list of Inputs with their user labels.

```
11:12      [Disable/Inputs]      Disab.:00
(00) Floor 1 I\0
(00) Floor 1 I\0 2
F1:Disabled                                     F3:Disable
```

Press **F3** to disable the selected Input. Press **F1** to see disabled Input list.

Outputs

```
11:12 [Disable/Outputs]
FAD
FPE
FBRE
FWRE
Others
```

FAD - list of disabled outputs programmed as FAD (If there are any disabled).

```
11:12 [Disable/Outputs/FAD] Disab.:00
F1:Enabled F3:Enable
```

By pressing **F1** “Enabled” will display list of FAD with their user labels.

```
11:12 [Disable/Outputs/FAD] Disab.:00
(01) Floor 1 sounder
F1:Disabled F3:Disable
```

Press **F3** to disable the selected FAD. Press **F1** to see disabled FAD list.

FPE – list of programmed outputs as FPE (If there are any disabled).

```
11:12 [Disable/Outputs/FPE] Disab.:00
F1:Enabled F3:Disabled
```

By pressing **F1** “Enabled” will display list of FPE with their user labels.

```
11:12 [Disable/Outputs/FPE] Disab.:00
(01) BIO Relay 1
F1:Disabled F3:Disable
```

Press **F3** to disable the selected FPE. Press **F1** to see disabled FPE list.

FBRE – list of programmed outputs as FBRE (If there are any disabled).

```
11:12 [Disable/Outputs/FBRE] Disab.:00  
  
F1:Enabled F3:Enable
```

By pressing **F1** “Enabled” will display list of FBRE with their user labels.

```
11:12 [Disable/Outputs/FBRE] Disab.:00  
(01) Monitoring output 1  
  
F1:Disabled F3:Disable
```

Press **F3** to disable the selected FBRE. Press **F1** to see disabled FBRE list.

FWRE –list of programmed outputs as FWRE (If there are any disabled).

```
11:12 [Disable/Outputs/FWRE] Disab.:00  
  
F1:Enabled F3:Enable
```

By pressing **F1** “Enabled” will display list of FWRE with their user labels.

```
11:12 [Disable/Outputs/FWRE] Disab.:00  
(001) Monitoring output 1  
  
F1:Disabled F3:Disable
```

Press **F3** to disable the selected FWRE. Press **F1** to see disabled FWRE list.

Others – list programmed device outputs (If there are any disabled).

By pressing **F1** “Enabled” will display list of Outputs Others with their user labels.

```
11:12 [Disable/Outputs/Others] Disab.:00
(00) Floor 1 I/O
(00) Floor 1 I/O 2
(00) BIO Relay 2
(00) User Output 1
F1:Disabled F3:Disable
```

Press **F3** to disable the selected Output. Press **F1** to see disabled Outputs list.

Disable/ Others - list of already disabled devices showed as “Others”. These are devices disabled by procedure “**F2: Disabled Fault Indication**” - two times reset default and then will be still active, gives an option by pressing **F2** to disable fault indication.

15. Menu Inhibit

```
11:12 [Inhibit]
Zones
Sensors
Inputs
Outputs ->
Others
```

Zones – first screen shows list of already inhibited zones (If there are any inhibited).

```
11:12 [Inhibit/Zones] Inhib.:00
F1:Allowed F3:Allow
```

By pressing **F1** “Allowed” will display list of inhibited zones with their user labels.

```
11:12 [Inhibit/Zones] Inhib.:00
01 Detection-zone 1
F1:Inhibited F3:Inhibit
```

Press **F3** to inhibit the selected zone. Press **F1** to see inhibited zone list.

Sensors –First screen shows list inhibit Sensors (If there are any inhibited)

```
11:12      [Inhibit/Sensors]      Inhib.:00  
  
F1:Allowed                                F3:Allow
```

By pressing **F1** “Allowed” will display list of inhibited sensors with their user labels.

```
11:12      [Inhibit/Sensors]      Inhib.:00  
(01) Floor 1 room 1  
(01) Floor 1 MCP  
F1:Inhibited                                F3:Inhibit
```

Press **F3** to inhibit the selected sensor. Press **F1** to see inhibited sensors list.

Inputs – First screen shows list inhibited Inputs (If there are any inhibited)

```
11:12      [Inhibit/Inputs]      Inhib.:00  
  
F1:Allowed                                F3:Allow
```

By pressing **F1** “Allowed” will display list of Inputs with their user labels.

```
11:12 [Inhibit/Inputs] Inhib.:00
(01) Floor 1 I\0
(01) Floor 1 I\0 2
F1:Inhibited F3:Inhibit
```

Press **F3** to Inhibits the selected Input. Press **F1** to see inhibited Input's list.

Outputs

```
11:12 [Inhibit/Outputs]
FAD
FPE
FBRE
FWRE
Other
```

FAD – list of Inhibited outputs programmed as FAD (If there are any inhibited)

```
11:12 [Inhibit/Outputs/FAD] Inhib.:00
F1:Allowed F3:Allow
```

By pressing **F1** “Allowed” will display list of FAD with their user labels.

```
11:12 [Inhibit/Outputs/FAD] Inhib.:00
(01) Floor 1 sounder
F1:Inhibited F3:Inhibit
```

Press **F3** to inhibit the selected FAD. Press **F1** to see inhibited FAD's list.

FPE – list of inhibited outputs programmed as FPE (If there are any inhibited)

```
11:12 [Inhibit/Outputs/FPE] Inhib.:00  
  
F1:Allowed F3:Allow
```

By pressing **F1** “Allowed” will display list of FPE with their user labels.

```
11:12 [Inhibit/Outputs/FPE] Inhib.:00  
(01) BIO Relay 1  
  
F1:Inhibited F3:Inhibit
```

Press **F3** to inhibit the selected FPE. Press **F1** to see inhibited FPE’s list.

FBRE – list of inhibited outputs programmed as FBRE (If there are any inhibited)

```
11:12 [Inhibit/Outputs/FBRE] Inhib.:00  
  
F1:Allowed F3:Allow
```

By pressing **F1** “Allowed” will display list of FBRE with their user labels.

```
11:12 [Inhibit/Outputs/FBRE] Inhib.:00  
(00) Monitoring output 1  
  
F1:Inhibited F3:Inhibit
```

Press **F3** to inhibit the selected FBRE. Press **F1** to see inhibited FBRE's list.

FWRE – list of inhibited outputs programmed as FWRE (If there are any inhibited)

```
11:12 [Inhibit/Outputs/FWRE] Inhib.:00
F1:Allowed F3:Allow
```

By pressing **F1** "Allowed" will display list of FWRE with their user labels.

```
11:12 [Inhibit/Outputs/FWRE] Inhib.:00
(00) Monitoring output 2
F1:Inhibited F3:Inhibit
```

Press **F3** to inhibit the selected FWRE. Press **F1** to see inhibited list.

Others – list of devices programmed as Outputs (If there are any inhibited)

```
11:12 [Inhibit/Outputs/Others] Inhib.:00
F1:Allowed F3:Allow
```

By pressing **F1** "Allowed" will display list of Outputs Others with their user labels.

```
11:12 [Inhibit/Outputs/Others] Disab.:00
(00) Floor 1 I/O
(00) Floor 1 I/O 2
(00) BIO Relay 2
(00) User Output 1
F1:Inhibited F3:Inhibit
```

Press **F3** to Inhibits the selected Output. Press **F1** to see inhibited Outputs list.

Inhibit/Others – all inhibited devices by Modbus monitoring will be displayed in this menu

16. Menu System

```
11:22 [System]
  Config
  Events
  Language
  Setup
  Information
  Stop
```

Configuration

```
11:22 [System/Config]
  Loop
  D-zones
  A-zones
  P-Zones
  DIN Modules
```

Loops – list of loop devices.

```
11:12 [System/Config./Loop]
  L1 Loop
```



Example: L1 Loop

Loop – user label of loop

'DZ-01' – number of Detection Zones in loop

'AZ-01' – number of Alarm Zones in loop

'PZ-01' – number of Protection Zones in loop

By arrows   all devices connected in Loop can be seen

LD 001 Smoke Detector – 'LD' loop Device '001' position in loop
Floor 1 room 1 – user label of Smoke Detector

A-zones – list of A-zones and their attached sounder devices and sensors which are configured in D-zones, which are in sub related to select A-zone. Visualized with user labels.

```
11:12 [System/Config./A-zones]
AZ 01 Alarm-zone 1

11:12 AZ1 (M0-L1 T=60) (1)
Alarm Zone-1
DZ 01
AZ
LD 009 Sounder Device
Floor 1 Sounder
```

The second menu gives detailed information about parameters of Alarm zone.

- M0 – L1 T=60 - Base loop module 0; Loop 1; Time delay –60 sec
- DZ 01 – Alarm zone 1 is being activated by Detection zone 1
- LD 009 Sounder Device – Alarm zone 1 has Sounder Device 009 attached

with user label “Floor 1 Sounder”.

D-zones – list of D-zones and their Attached sensors (fire detectors, manual call points, I/O -BIO inputs)

```
11:12 [System/Config./D-zones]
DZ 01 Detection-zone 1
```



```
11:12 DZ001 (M0-L1) (11)
  detection-zone 1
  AZ1 PZ1 CI:-
  LD 001 Smoke Detector
  Floor 1 room 1
  LD 003 ManualCallPoint
  Floor 1
  LD 005 SmokeDetektor
  Floor 1 room 2
```

P-zones – list of P zones and their attached outputs (I/O – BIO outputs) and sensors which are configured in D zones, which are in sub related to selected P-zone.

```
11:12 [System/Config./P-zones]
  DZ 01 Detection-zone 1
```

```
11:12 PZ1 (M0-L1 T=60) (1)
  Protection -Zone-1
  DZ 01
  BD1 RelayOutput
  BIO Relay 1
```

Example: PZ1 (M0-L1 T=60) –Loop 1 Time-Delay -60 sec.

Protection-zone 1 – is user label (configuration by WinUniConfig tool)

DZ 01 – Activation zone (configuration by WinUniConfig tool)

BD1 Relay Output – Activated device (configuration by WinUniConfig tool)

BIO Relay 1 – User label of activated device (configuration by WinUniConfig tool)

DIN Modules – list and configuration of DIN Modules.

M2 (7) – Module 2

BIO 1 – (first module is 7000-1MC) – user label

```
11:12 M2 (7)
  BIO 1
  BD1 FPE PZ1 RelayOutput
  BIO Relay 2
  BD2 CommonOutput RelayOutput
  Monitoring Output 1
  BD3 FBRE MonitoredOutput
  Monitoring Output 2
  BD4 FWRE MonitoredOutput
  Monitoring Input 1
  BD5 FBREConfirm MonitoredInput
  Monitoring Input 2
  BD6 FWREConfirm MonitoredInput
  User Output 1
  BD7 CommonOutput UserOutput
```

First line – BIO 1 - Device Label

BIO device 1 (BD1) (relay output 1) is user configured by WinUniConfig as Fire protection Equipment in Protection Zone

Second Line - BIO device configuration

BIO device 2 (Relay output 2) is user configured by WinUniConfig as Common Output

BIO device 3 (Monitoring Output 1) is user configured by WinUniConfig as Fire Brigade Routing Equipment

BIO device 4 (Monitoring Output 2) is user configured by WinUniConfig as Fault Warning Routing Equipment

BIO device 5 (Monitoring Input 1) is user configured by WinUniConfig as Fire Brigade Routing Equipment Confirmation

BIO device 6 (Monitoring Input 2) is user configured by WinUniConfig as Fault Warning Routing Equipment Confirmation

BIO device 7 (User Output) is user configured by WinUniConfig as Common Output.

Events

All – list of all events

Fires – list of all fires

Faults – list of all faults

Disablement – list of all disablement

Inhibits – list of all inhibits

Tests – list of all tests

```
11:12 [System/Events]
All
Fires
Faults
Disablen.
Inhibits
Tests
```

Language - control panel came pre-configured: English, Bulgarian and Russian

```
11:12 [System/Language]
*en English #
  bg Български
  ru Русский
```

SETUP

```
11:22 [System/Setup]
Time
Logfile
```

Time – set up of time and date, the presence of LAN connection date and time are set up automatically.

```
11:12 [System/Setup/Time]
10:11:00 01-04-2020

F1:Increment      F2:Decrement      F3:Set
```

Logfile – erase panel's log files. Default pass. (F1F1F2F2). Press **F3** to delete.

```
11:22 [System/setup/Logfile]
F3: Erase events log
```

STOP

```
11:22 [System/Stop]
Poweroff
Restart
```

Power off/Restart – recommended procedure of panel stops or restart, password verification, then press  to confirm panel restart.

```
11:22 [System/Stop/Poweroff]
F1: Confirm
```

Information – this menu contains the system’s software and hardware information.

```
11:22 [System/Information]
UniPOS 7000-1MC Fire Alarm System
ID:
FW:R.1.0 Jul 20 2021 15:58:29
```

17. Menu Services

```
11:12 [Service]
Test->
Calibration->
Schedule->
Addressing->
Diagnostics->
Maintenance->
```

Test

```
11:12 [Service/Test]
Zone
Walktest
Silent-WT
Outputs
Indication
Devs-LED
```

Zones

```
11:12 [Service/Test/Zones]      T-Zone:00
01 Detection-Zone 1
02 Detection-Zone 2
F1:Test-zones  F2:Fast Scroll  F3:Start
```

Select from the Detection zone's list the zone and press **F3** to send selected zone in Zone test mode.

Activating any fire detector or manual call point. Same valid for Walk test and Silent walk-test --fire detectors which belong to Detection zone will activate adjacent Alarm zone and their sounders for 10 seconds. - valid for Walk test as well.

Walk test

```
11:12 [Service/Test/Walktest]  T-Zone:00
01 Detection-Zone 1
02 Detection-Zone 2
F1:Test-zones  F2:Fast Scroll  F3:Start
```

Select from the Detection zone's list the zone and press **F3** to send selected zone in Zone test mode. **F2** will scroll with 10 lines down.

Detection zone will activate adjacent Alarm zone and their sounders for 10 seconds.

Silent Walk - test

```
11:12 [Service/Test/Silent-WT] T-Zone:00
01 Detection-Zone 1
02 Detection-Zone 2
F1:Test-zones F2:Fast Scroll F3:Start
```

Select from the Detection zone's list the zone and press  to send selected zone in Zone test mode.

Outputs

```
11:22 [Service/Test/Outputs]
L1 D004 I/O Output 1
L1 D005 Sounder 1
L1 D010 Sounder 2
```

Selected Output as Sounder Device or I/O output will be activated for 10 sec.

Please note that any executable devices different than sounders shall be monitored or disconnected from I/O terminals during Output tests.

Indication

```
11:12 [Service/Test/Indication]
BUI-Test--fire sound alarm
```

All panel LED indication will be activated for a few seconds including panel buzzer.

Fast test – double press BUI button  (requires no active faults)

Devises - LED test

```
11:22 [Service/Test/Devs-LED]
L1 Loop
```

Select loop from the list and press button 'Menu'.

```
11:12 [Service/Test/devs-LED]
L1 D001 Combine Detector - 1
L1 D002 Heat Detector - 2
L1 D003 Smoke Detector - 3
```

Select device from the list press button 'Menu' and the device's LED and remote indicator (if connected) will be activated.

Calibration – Displays non calibrated BIO devices monitoring outputs

```
11:12 [Service/Calibration/BIO]
Calibrate BIO 2 output 3
Calibrate BIO 2 output 4
```

Select non-calibrate BIO device and press 'Menu' button – it will start automatic calibration procedure.

Note: BIO output terminal and cable connections shall be checked before executing calibration procedure.

Schedule

```
11:12 [Service/Schedule/Day-Night]
Day mode
Night mode
*Auto mode
```

Symbol "*" indicates active or selected Day-Night mode.

–**day mode** – if day mode is selected by pressing the button “Menu”, day settings are activated to all fire detectors, until operator activates other option in this menu.

–**night mode** - if night mode is selected by pressing the button “Menu”, night settings are activated to all fire detectors, until operator activates another option in this menu

– **auto mode** - auto mode is default selected, when is used xml configuration. Day and night settings will be changed by schedule configured in xml file.

Addressing – by this menu all connected DIN Modules can be addressed by the fire panel.

Loop – this menu will address only loop's devices.

```
11:22 [Service/Addressing]
Loop
Modules
All
Save config
Restart
```

For example, **loop** is addressing – this is automatically operation done by the fire panel, when it's completed shows the total number of the addressed loop devices. (ex. **LD:150 pcs.**)

```
11:22 [Sevrice/Addressing/Loop]
LD:150 CL:16 BD:21
Configuration generated
```

To save system configuration go to the next menu “**Save Configuration**”.

Diagnostics – this menu is uses only from UniPOS maintenance service.

```
11:12 [Service/Diagnostics]
RS485-DIN
RS485-BUI
```

Maintenance – Default Pass (F1F1F2F2) – to connect with PC

```
11:12 [Service/Maintenance]
USB-Transfer
```

18. Menu Messages

In this menu can be displayed messages from technical inputs /general purpose inputs/

```
11:13      [Info Messages]      Total:02
01 Noncalibrated BIO 2 output 3
02 Noncalibrated BIO 2 output 4
          F3:Confirm
```

Example:

Non-calibrated BIO outputs or activated I/O or BIO inputs are shown in Messages

Message is blinking when it isn't confirmed, to confirm select and press button



19. Pre-installation

19.1 Location

The Fire Alarm Control Panel or Operator Panel must be in, or nearby, the entrance according to local regulations and in consultation with the fire brigade.

Environmental Requirements

The equipment complies with environmental conditions of EN 60721-3-3:1995, class 3k5 (refer to EN 54-2, chapter 12.1.6).

Operation temperature:	-5°C to +40°C
Storage temperature:	+5°C to +35°C
Transportation temperature:	-10°C to +50°C

Humidity

storage	– up to 80%
operational	– up to 93%

Cabinet size	420x260x220mm
---------------------	---------------

Transportation:

The CIE shall be transported by vehicle, in factory packaging, in the above stated environmental conditions and at sinusoidal vibrations with acceleration amplitude not more than $4,9\text{m/s}^2$ in frequency range 10 to 150Hz.

Degree of protection: IP30

19.2 Warranty

The manufacturer guarantees compliance of the unit with EN 54-2: 1997/ A1:2006/AC: 2009, EN 54- 4:1997/A2: 2006/AC 2009. The warrant period is 24 months from the date of the purchase, providing that - the conditions of storage and transportation have been observed; - the startup has been done by authorized personnel only; - the requirements for operation stated herein have been observed.

19.3 Mounting Height / Space Requirement for Control Panel

To ensure optimal readability of the Fire Alarm Control Panel's display, the recommended mounting height of this cabinet top is approximately 175(/150) cm above the floor. Other panels should be mounted accordingly.

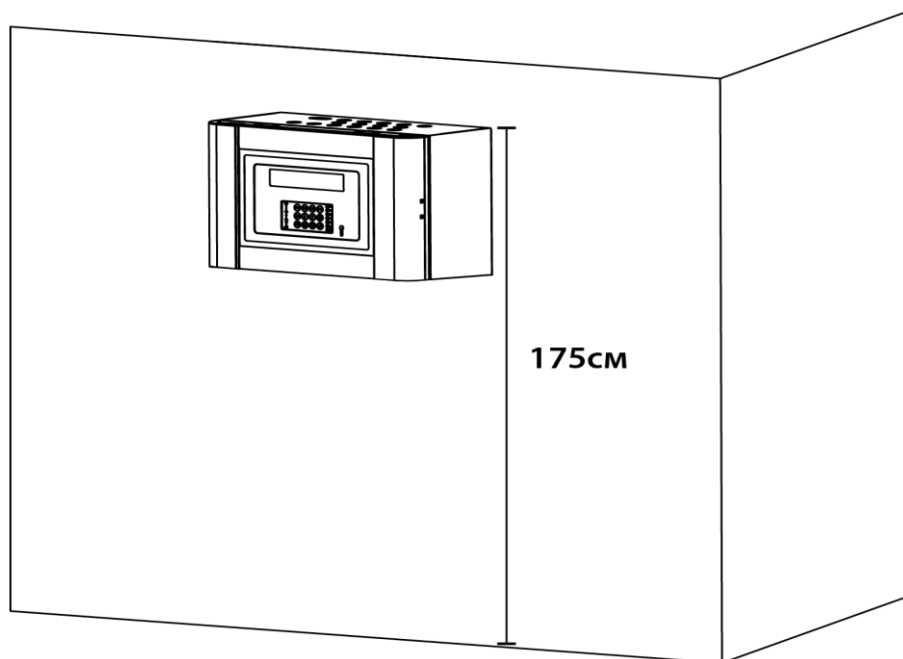

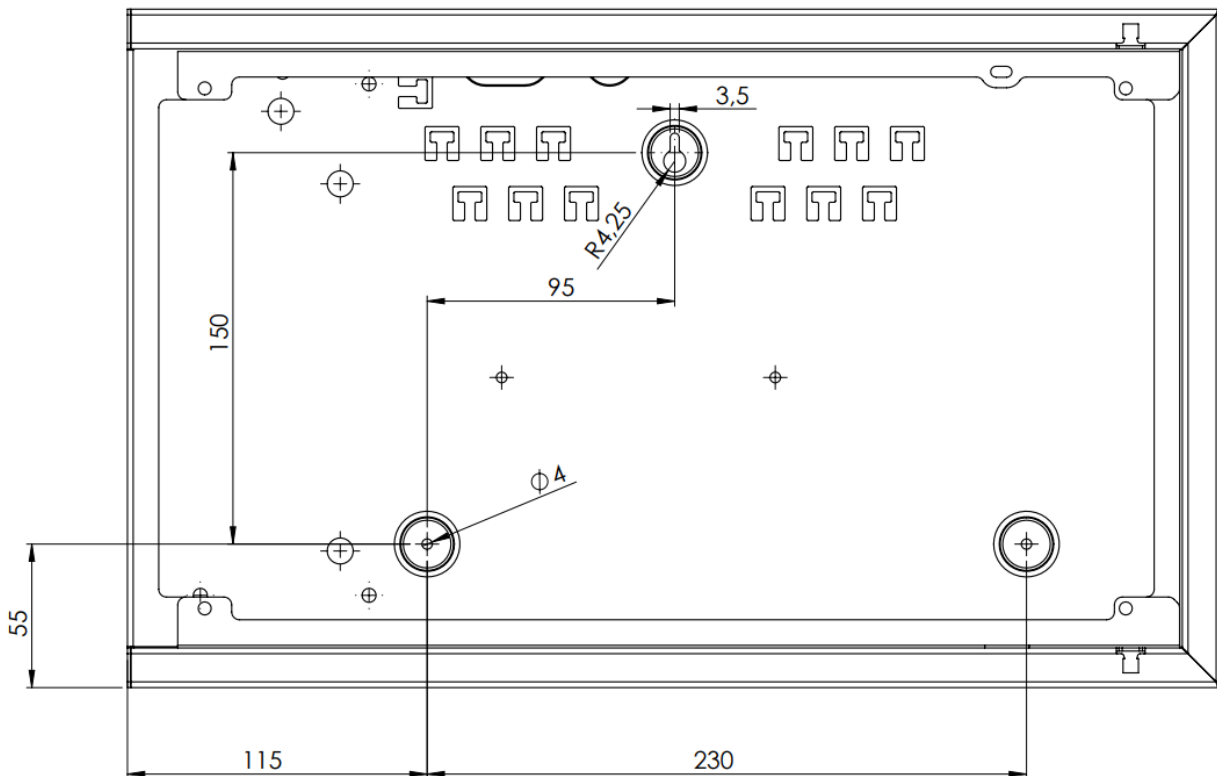

Mounting Fire Alarm Control Panel 7000-1MC

Depending on the type of wall, please use suitable fasteners with a minimum load capacity of 140N each. Distribute the load on each of the fasteners evenly.

- Mark and drill the 3 holes according to the following scheme
- Partly fasten the upper screw
- Hang the cabinet onto the upper screw
- Partly fasten the bottom screws
- Tighten all screws

Accessing DIN rail module inside the Control Panel

1. Use screwdriver to unscrew hood screws and open both hoods.
2. Find openings side of the panel
3. Unscrew both screws and open the metal hood gives access to DIN modules and power supply unit.

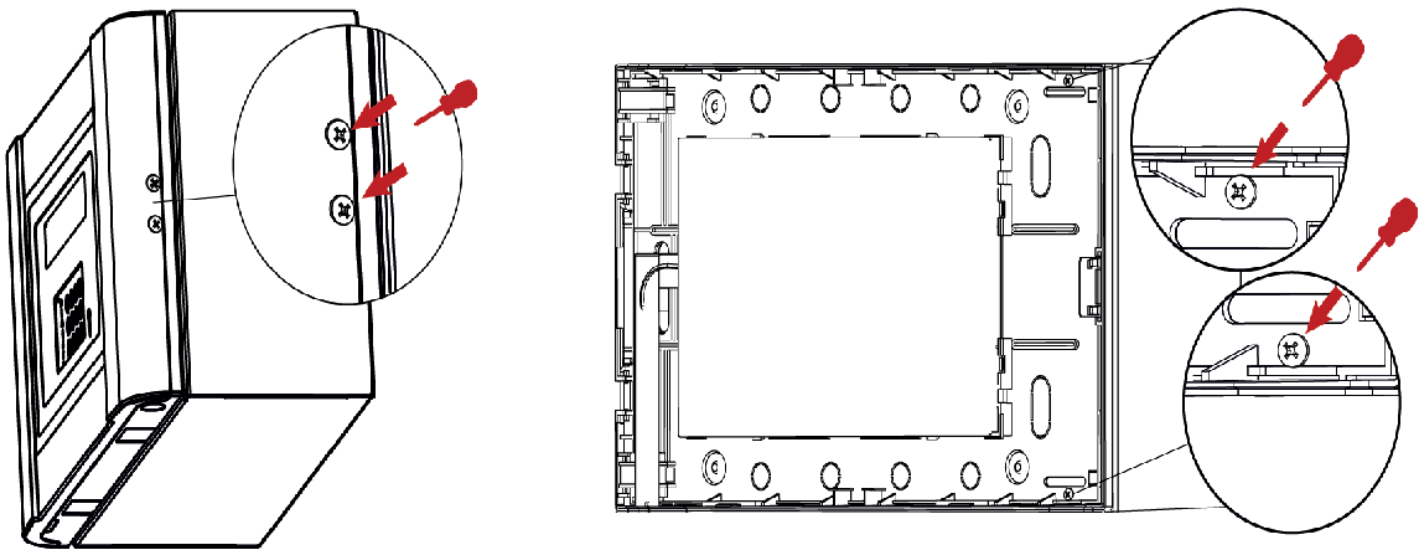

19.4 Power Supply Unit (PSU)

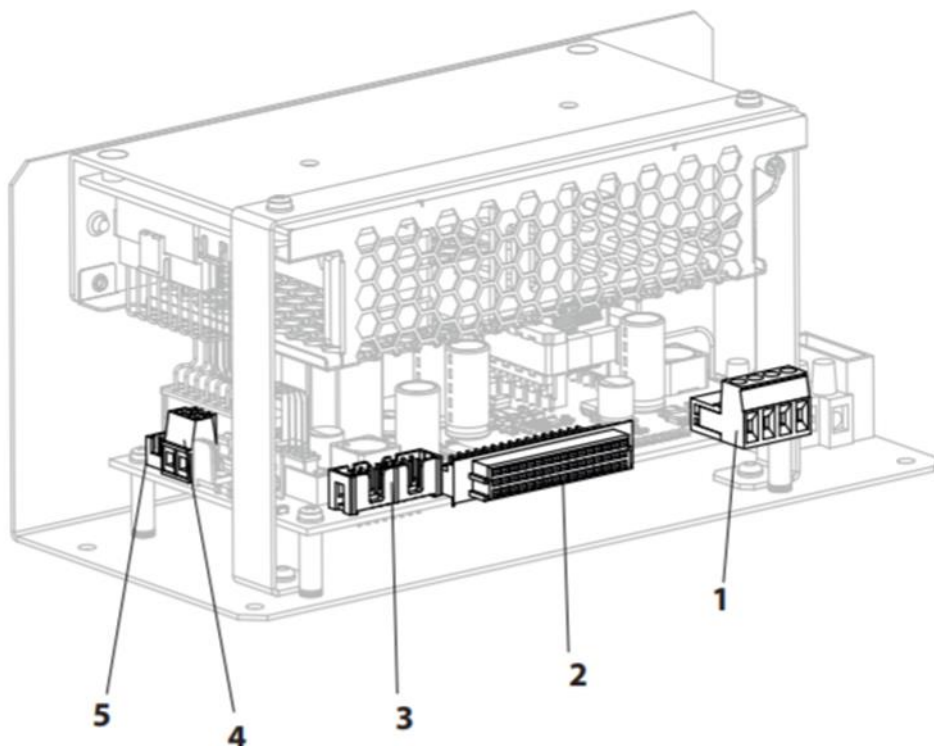

- 1 – Two user Outputs 27.6VDC/0.7A – permanently supplied – used for power supply of repeaters and extended zonal indications
- 2 – DIN rail connector
- 3 – BUI power-communication cable
- 4 – Battery connector

5 – Battery Temperature sensor

There is an information sticker on the top of the PSU.

19.5 Battery installation

The panel requires two 12V/12A batteries for standby operation.
OBSERVE THE POLARITY OF CONNECTIONS!

Place the batteries in the bottom of the enclosure and connect the 'Red' lead to the positive (+) terminal of battery #1 and the 'Black' lead to the negative (-) terminal of battery #2. Connect the negative of battery #1 to the positive of battery #2 using the supplied link cable.

Ensure that the battery terminals do not short out against any part of the enclosure, circuit board or chassis plate.

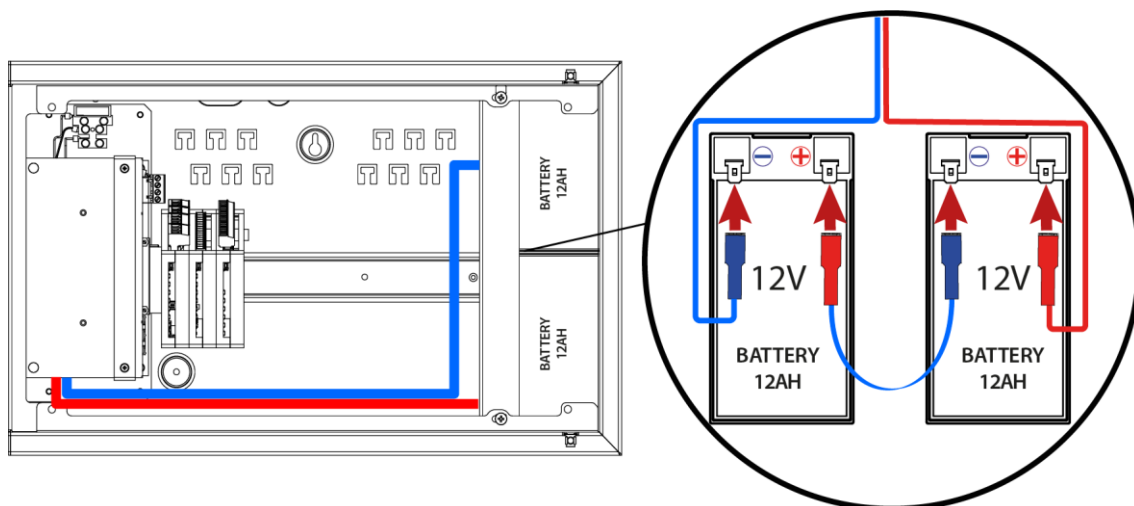

Do not make the final battery connections until the installation wiring is completed and the system is powered up.

Always connect the **AC Mains** input before connecting the **battery unit**.

19.6 Panel - Repeater Connection (RS-485)

Every panel maintained one repeater connection realized by RS485 communication protocol. The maximum distance Panel - Repeater is 100 meters.

Repeater (BUI1) and External zonal indication (BUI2) share one network address which can be set by 4 position DIP switch. 7000-1MC have one repeater the position of the DIP switch DIP1-ON

Example: Setting address 1 can be set from DIP1 to DIP4 as ON, OFF, OFF, OFF.

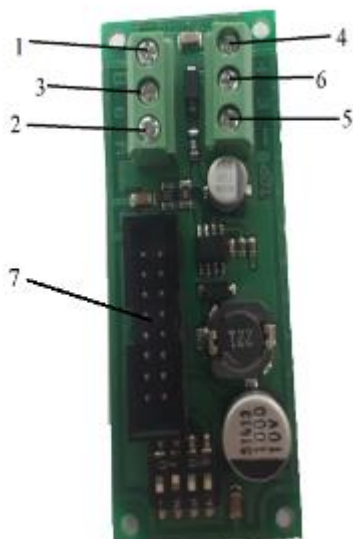
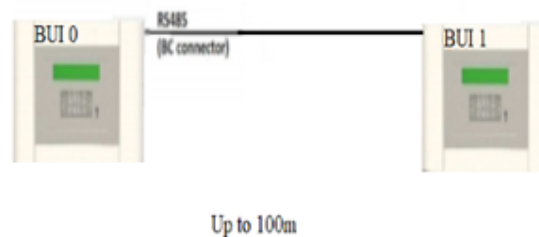

- 1 – RS 485 B
- 2 – Panel GND
- 3 – RS 485 A
- 4 – +28V
- 5 – -28V
- 6 – Earth
- 7 – Ribbon cable connection to keyboard and display

This board must be connected to Base controller RS485 and 7000M-PSU-160 User Output.

RS485 termination shall be done on both sides of the communication bus. Termination from the control panel side is preset by default. At the Repeater must be placed resistance 120Ω on 1 – RS 485 B and 3 – RS 485 A (if there is no zonal indication in configuration).

If 7000M-R (Repeater) has external 7000M-L (zonal LED indication) must be terminated by 2 position DIP switch (at the last repeater) where position 1 is termination and position 2 is configuration of left and right LED board (this LEFT/RIGHT position is preconfigured by the manufacturer). The right LED board (when the LED board box is not open) must set DIP 1-ON and LED board left DIP1-OFF. (Please NOTE when the LED board is disassembled position left and right are changed).

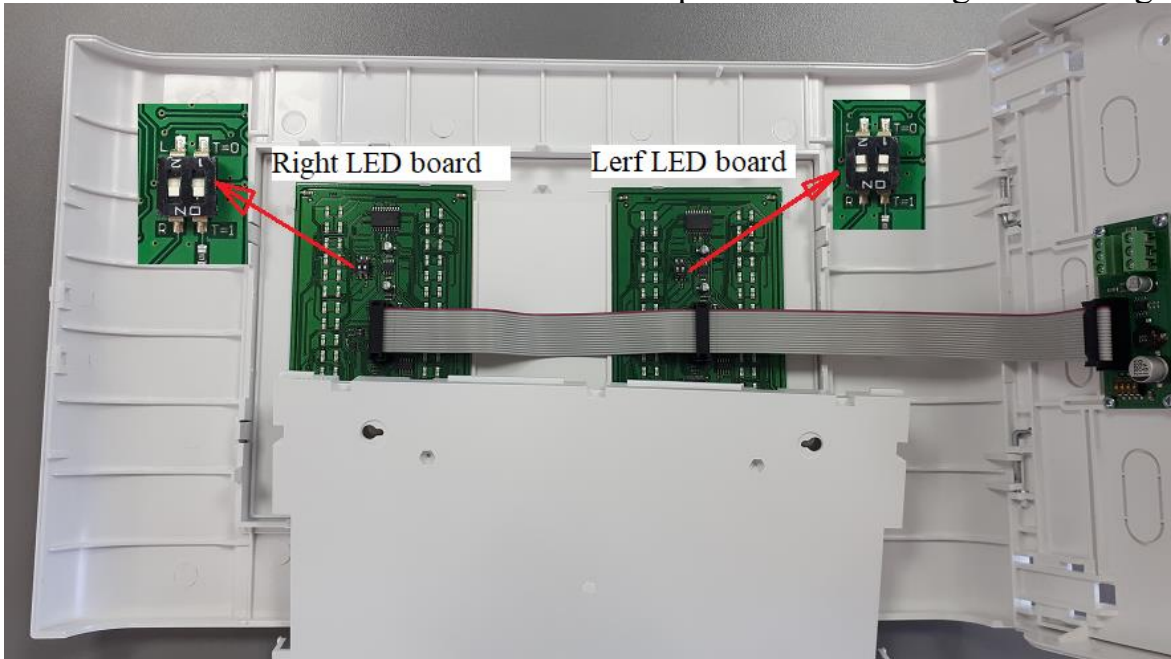

When the External zonal indication is connected to the repeater - the DIP switch of the extension board must be with the same address as the repeater.

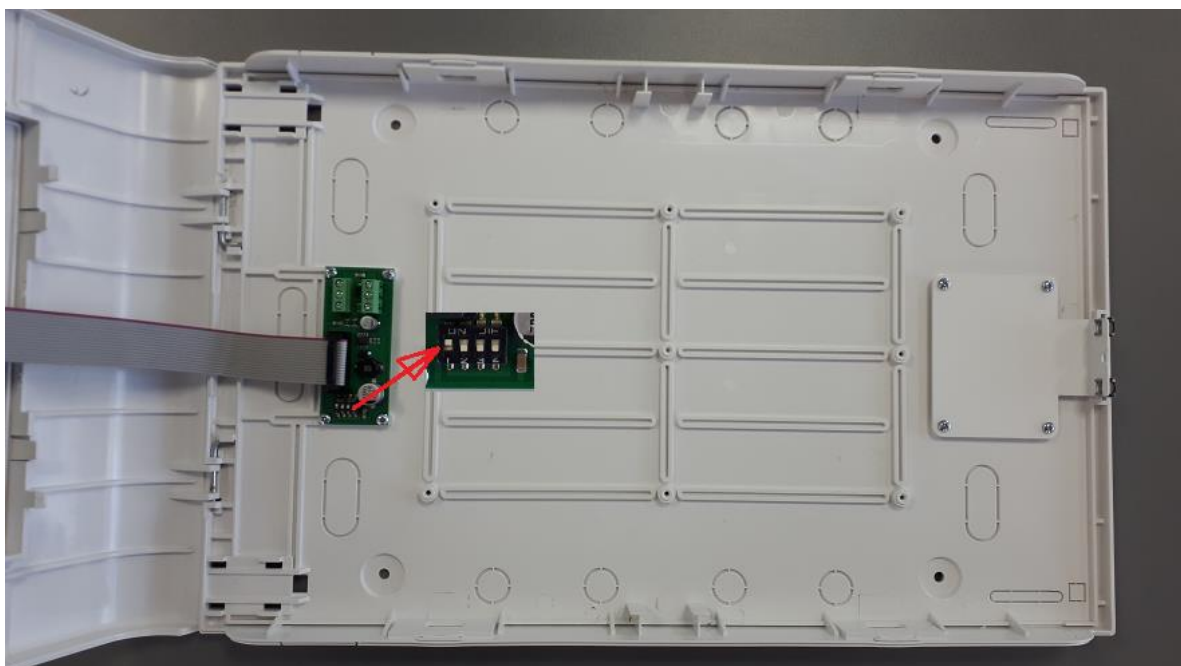

Integrity of transmission paths: RS485 does not support redundant communication. In case of a single fault communication could be disturbed, which will be indicated in a proper way on the Control panel.

20. System information

From menu **System** -> **Information** can be acquired information about firmware version.

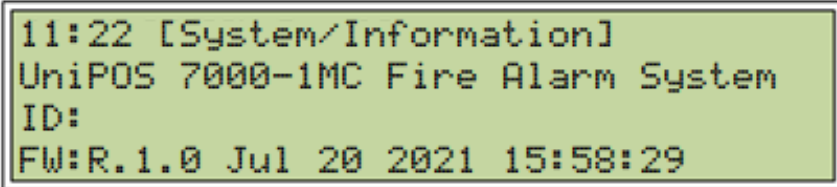

```
11:22 [System/Information]
UniPOS 7000-1MC Fire Alarm System
ID:
FW:R.1.0 Jul 20 2021 15:58:29
```

21. Initialization of Loop devices

Initialization is a verification process in which a check is started to compare the devices in the loop and the configuration file, to detect exchanged or replaced with new devices. The check is done by typing and ID.

Detections of differences during initialization are saved in the log file of the panel. The logo shows the expected and new device ID, which can be exchanged or replaced with a new one for the loop. In this way, devices are replaced with new, of the same or different type, defective devices.

21.1 Exchange or replacement of devices of the same type

21.1.1 Replacement a devices of the same type

After initialization, the loop retains its operability and the devices are in standby mode, the new device that replaced the old one is initialized and is in operable mode.

After starting the panel is in "**Fault mode**" and an information message appears:

```
7000-1MC Test Company
7000-1MC Test Site
Normal Operation
Wed 01-01-21 11:22:00 Day
```

Information message:

```
11:12 [Messages] Total:01
Loop 1 devices changes - see log

F3:Confirm
```

Messages in archive:

```
11:12 [System/Events/All] 5-3147
01-01 11:12 Stop buzzer by BIO
01-01 11:12 Position changed point 8
01-01 11:12 Position changed point 7
```

```
11:12 [System/Events/All] 4
01-01-21 11:12:00 Position changed
point 8 L1 (Smoke Detector) (Smoke
Detector 8) (LC)
```

```
11:12 [System/Events/All] 5
01-01-21 11:12:00 Position changed
point 7 L1 (Smoke Detector) (Smoke
Detector 7) (LC)
```

Panel in "Fault mode":

```
11:12 [Fault Mode] All:02
01 =T-Smoke Detector-7
02 =T-Smoke Detector-8
```

Symbol "=" changed / exchanged device

Clearing the fault:

The panel is in "Fault Mode" and has a "Messages" indication. The log file records the expected and found ID of the swapped/swapped devices. Through the UniConfig

software, the configuration file must be updated (replace the old one with the new device ID) and load the XML configuration back into the panel.

21.1.2 Swapped devices of the same type

In the case of exchanged devices, it is necessary to restart the panel, when switching to standby mode and in "Damage mode", the exchanged devices do not have verified positions - they are not in working mode.

The display shows:

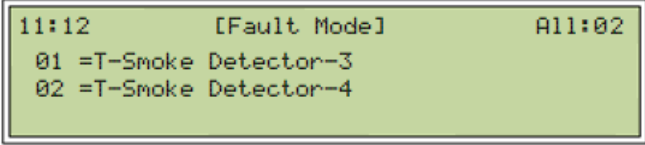

```
11:12      [Fault Mode]      A11:02
01 =T-Smoke Detector-3
02 =T-Smoke Detector-4
```

"=" symbol replaced/exchanged device

Clear the fault:

The swapped positions of the devices are recorded in the logs:

```
eveng.log
Loop 1 device 3 changed (ID DF356A16 -> 34366A16)
Loop 1 device 4 changed (ID 1D301B94 -> DF356A16)
```

They are returned to their positions corresponding to the XML configuration. A panel restart is required.

21.2 Swapped devices of different types

After loop initialization, only swapped devices of a different type are not initialized - they are not operational. From the entry in the log file, the swapped devices are determined and returned to their positions in the loop corresponding to the XML configuration.

21.3 Replacing devices of different types

After initializing the loop from the log file, the ID of the replaced with the new device is taken, deleted in the configuration XML via UniConfig the old device in the loop, a new device is created and configured which must have the same sequence number in the loop as the deleted device. After saving the changes, the XML file is loaded into the panel.

22. Manufacturer of re-initialization of fire alarm counter



Reset of fire alarm counter can be done only from authorized personnel on Access level 4.

Through the Windows “Command Prompt” app make USB connection with panel 7000-1MC.

(Go to menu System/Maintenance (see p.76) and activate USB – connection.)

Open **dfuprog.exe**

write following command: **dfuprog -v -j -r**

Send it to the panel.

The fire counter will be reset, (**also all stored settings example as disables**) and panel will restart.