

**Contents**

<b>UniConfig – Configuration Steps</b> .....	<b>2</b>
<b>1. System Configuration:</b> .....	<b>5</b>
<b>2. Panel Settings:</b> .....	<b>10</b>
<b>2.1 Smoke Detector -FD7130M:</b> .....	<b>13</b>
<b>2.3 Heat Detector -FD7120M:</b> .....	<b>16</b>
<b>2.4 Input Output module -7203M:</b> .....	<b>18</b>
<b>2.5 Addressable Sounder -7206M:</b> .....	<b>20</b>
<b>2.6 Manual Call Point -FD7150M:</b> .....	<b>20</b>
<b>2.7 Conventional line Adapter -7201M:</b> .....	<b>21</b>
<b>3. Zones</b> .....	<b>22</b>
<b>3.1 Detection zones</b> .....	<b>22</b>
<b>3.2 Alarm zones</b> .....	<b>23</b>
<b>3.3 Protection zones</b> .....	<b>26</b>
<b>4. Basic Input Output (BIO) module configuration</b> .....	<b>27</b>
<b>4.1 Relay Output 1/2– BIO device 1/2:</b> .....	<b>28</b>
<b>4.2 Monitored Output 3/4 – BIO device 3/4:</b> .....	<b>29</b>
<b>4.3 Monitored Input 5/6 – BIO device 5/6:</b> .....	<b>32</b>
<b>4.4 User Output 7 – BIO device 7:</b> .....	<b>34</b>
<b>5. Fixed logic – Coincidence (CI) modes settings:</b> .....	<b>35</b>
<b>5.1 CI-mode A:</b> .....	<b>36</b>
<b>5.2 CI-mode B:</b> .....	<b>37</b>
<b>5.3 CI-mode C:</b> .....	<b>38</b>
<b>6. Repeater configuration (BUI and BUI1 devices)*</b> .....	<b>39</b>
<b>7. Script configuration</b> .....	<b>43</b>
<b>8. Conventional line DIN8CL module. (Available only for system 7000-1MC)</b> .....	<b>48</b>
<b>9. Minimal Configuration</b> .....	<b>50</b>
<b>10. PC Regional Setting:</b> .....	<b>57</b>
<b>11. Add new fire devices to XML configuration</b> .....	<b>58</b>
<b>12. CAN network configuration</b> .....	<b>59</b>
<b>13. 7000-1MC/7000M-1L – USB driver installation</b> .....	<b>62</b>

# UniConfig



Revision 3.0 05/03/26

# UniConfig – Configuration Steps

This manual contains instructions on how to setup correctly all components of addressable fire alarm panel 7000M / 7000-1MC / 7000M-1L using configuration tool UniConfig.

UniConfig tool is applicable only for Windows operational systems. Download and install *UniConfig.exe* from UniPOS website - <http://unipos-bg.com/>.

Configuration software works in web browser environment. Usage of Chrome browser is highly recommended. Please use the mouse for easier navigation through the program.

Start *UniConfig* and select system you will working with.

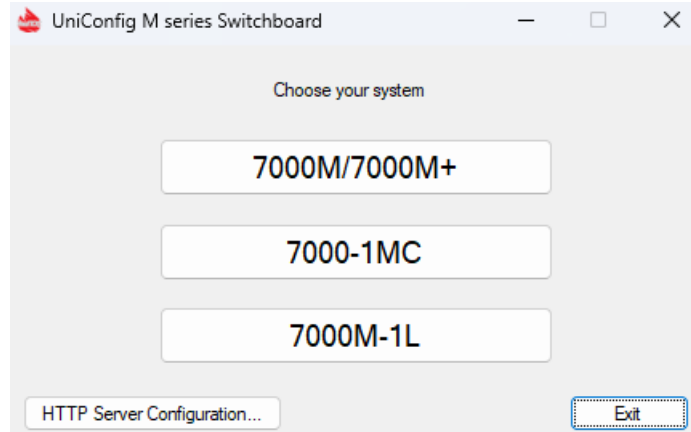

Press button “*Open*”

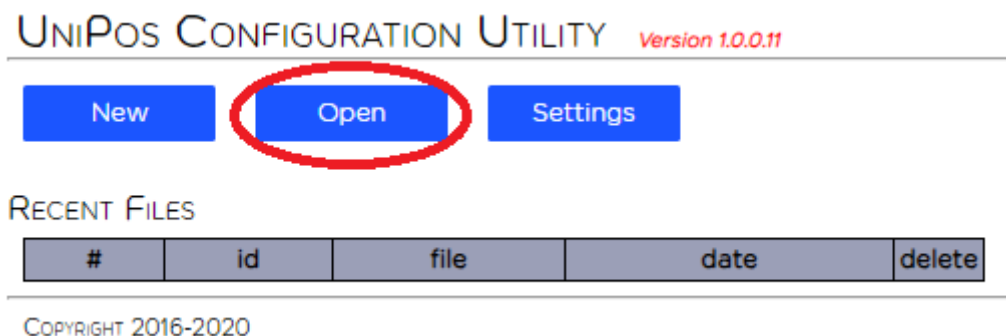

From the open dialog window select the xml file you need to configure. This file is loaded from the fire alarm panel, subjected to configuration.

For the purposes to generate xml file, please follow steps in Chapter 5 from the 7000M Instruction Manual.

*Example of configuration loaded from the panel for the first time:* All components from the system are depicted hierarchically starting with global system options, through network panels, panel modules, loop modules, BIO modules, loop devices and others.

„???“ – means that the system expects user actions for that element.

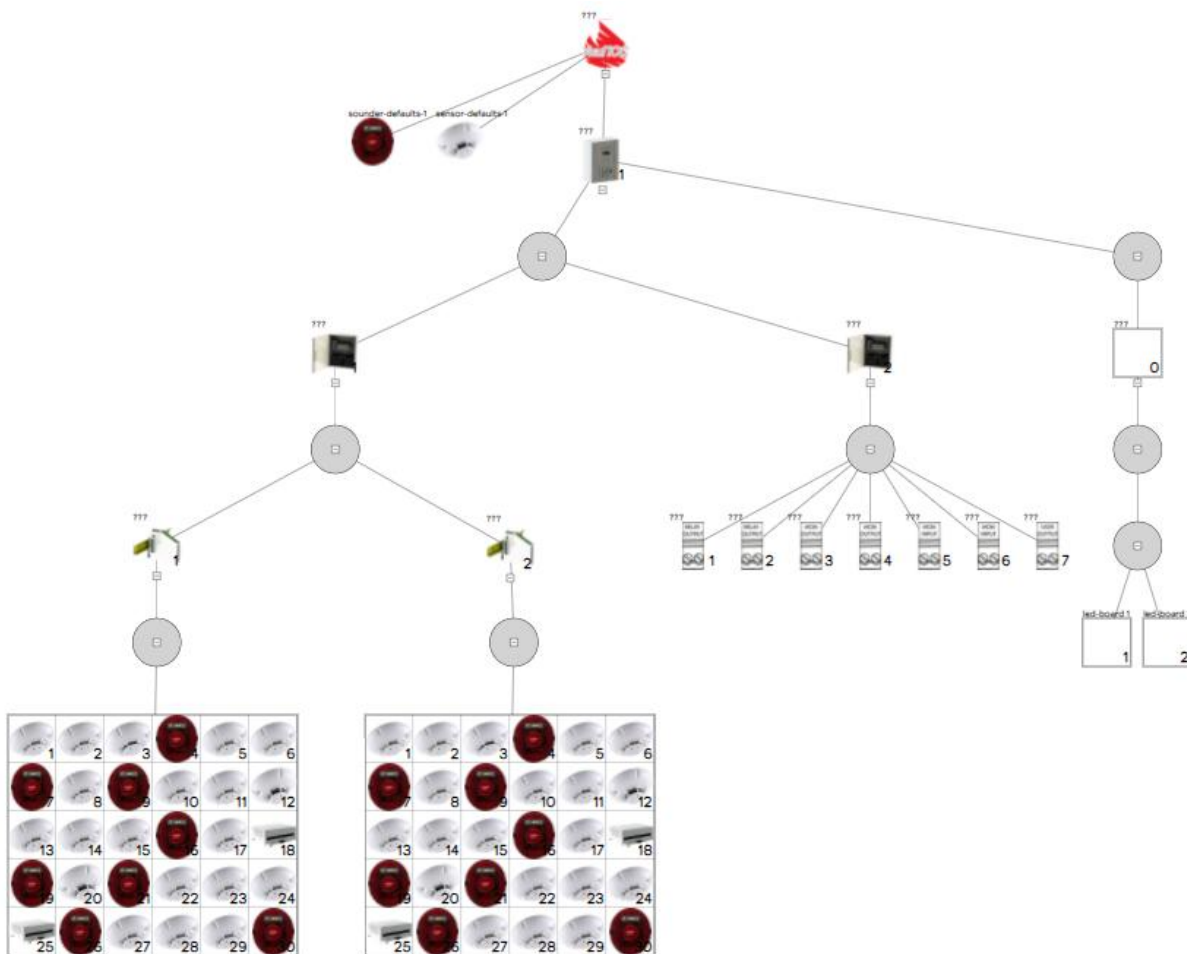

### Navigations:

Pointing with the mouse over the element will show a green notification window with all settings for the selected element.

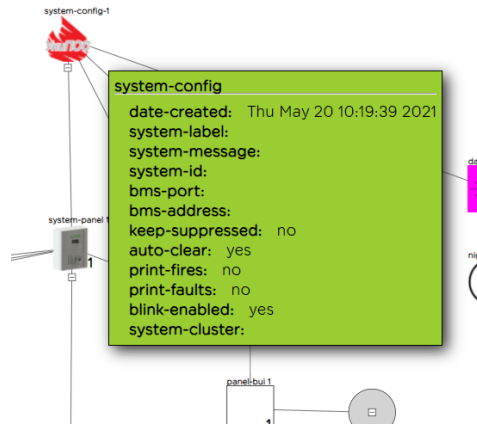

Edit of the element can be done with double click on it.

Always check the bottom part of the window for validation messages. In case of proper configuration this field will be empty. Otherwise, more user actions are required. For more information about possible messages, please check the table at the end of this manual.

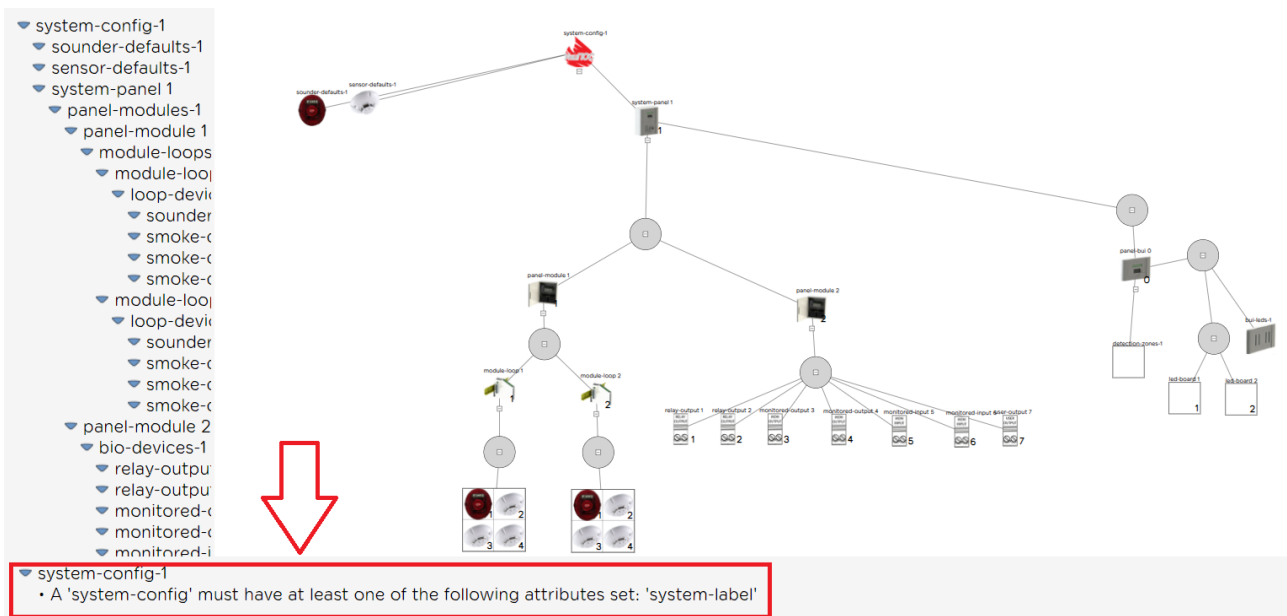

# 1. System Configuration:



**SYSTEM-CONFIG**

date-created:

system-label:

system-message:

system-id:

software-version:

bms-port:

bms-address:

keep-suppressed:  ▼

print-fires:  ▼

print-faults:  ▼

blink-enabled:  ▼

system-cluster:

*Date created:* configuration creation date

*System Label:* system name - user label text. This label is always presented on the display of the panel;

*System Message:* user label text. This label is always presented on the display of the panel. Can be used for maintenance company details-telephone, address etc.

*System id* – panel unique name

*Software-version:* software unique version

*BMS port* is pre-defined to 502.

*BMS-address:* IP address of BMS host

\* *IP address set* – only the set IP address can have access to the panel

\* *IP address not set* – every IP address can have access to the panel

*keep suppressed* – if option *yes* is selected, the second fire event will not re-enable already suppressed sounders from the first fire event.

If option *no* is selected, the second fire event will re-sound all already suppressed sounders from the first fire event.

*auto-clear* – if option *yes* is selected, then all faults which are already recovered can be reset without additional user confirmation

*print fires, print faults* – in case of printer attached to the fire panel, printer can print the chosen type of events.

*blink enabled* – global setting for all loop devices in the fire alarm system. Every 16 sec. the device red LED will blink shortly. Every device can have ownblink setting which override the global/system one.

*system cluster*

– in case that the configuration includes panels which shall work in network configuration, this option shall be selected. Up to 15 panels can be configured in one network.

## 1.1 Sounder Defaults:

sounder-defaults-1



**SOUNDER-DEFAULTS**

sounder-alarm:

sounder-warning:

“*Sounder Defaults*” set alarm and warning sound to all Sounders in the system. If an Alarm zone (see Alarm zone Settings) has set an alarm and warning sound those settings will be with priority over the settings at “*Sounder Defaults*”.

Sounder Sounds: slow whoop (alarm sound) and USA temporal (warning sound) are available.

## 1.2 *Sensor Defaults:*

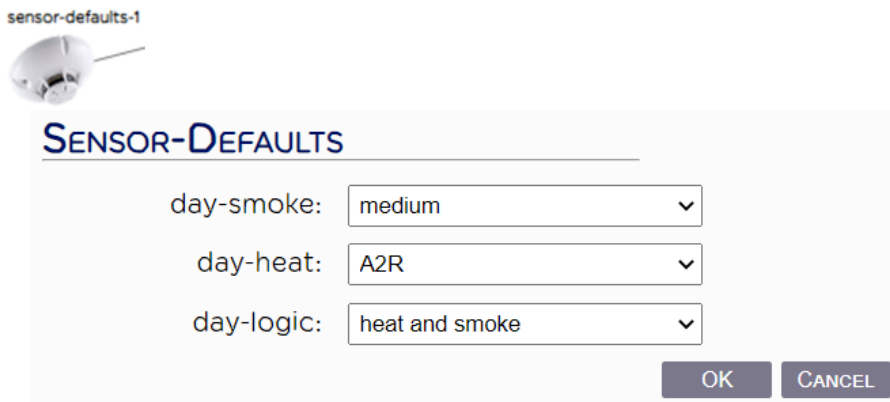

„*Sensor-Defaults*” – set settings as day-smoke, day-heat, and day-logic. Those settings are global for all detectors in the system and are set by default. In case the user wants to change these settings for each specific detector or zone - this can be applied accordingly for any detection zone or detectors;

*Day-Smoke settings:* **Low, Medium, High.** Default value for each smoke detector is **Medium** and can be increased or decreased with 10% using **Low** or **High** settings. These settings are global but can be change for any detection zone or detectors;

*Day-heat settings:* **A2R** - Detector activates by temperature increasing  
**A2S** - Detector do not respond below 54°C

Default value for every heat detector is A2R and can be changed to A2S. Those settings are global but can be changed for any detection zone or detectors;

*Day-logic settings:* **only heat; only smoke; heat and smoke and heat or smoke.**

**only heat** – combined detector is set to rise alarm only from temperature part;

**only smoke** – combined detector is set to rise alarm only from optical-smoke part;

**heat and smoke** – combined detector is set to rise alarm only when both sensor parts are triggered;  
**heat or smoke** – combined detector is set to rise alarm on temperature or optical-smoke part;

This setting is applicable only for Combine detectors. Default value – **heat and smoke**. Detectors or Zone setting of this parameter overrides “*Day-logic settings*”

### 1.4 Day Settings:

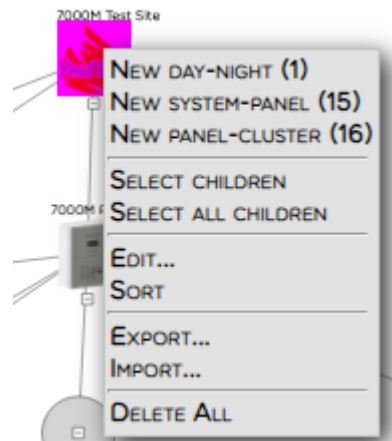

#### DAY-NIGHT

---

day-indicator:

day-delay:

night-delay:

week-days: M T W T F S S

day-start:

day-length:

*day-indicator*: if *yes* Control panel and Repeater led 4 will be always set ON during pre-set day interval.

*day-delay*: add delay time to all Alarm zones. This time is added to each alarm/protection-zone, parameter output delay. Default delay is 0.

For example: Day delay set to 60seconds.

Output delay for Alarm/Protection zone1 – 120 seconds, during day period this delay will be extended to 120 seconds + 60 seconds = 180 seconds.

**Note**: When output-delay parameter for Alarm/Protection-zone is 0 than zone will activate immediately ignoring day-delay value;

*Week-days*: list of week days, marked ones are with active *day-start* and *day-length* settings.

*Day-start*: time period from which the *day-night* settings will be active

*Day-length*: time period during which the *day-night* settings will be active. Period could not be longer than end of the same day. For example: Day-length is 12hours and day start is at 13:00 o'clock is not allowed setting.

*night-delay*: If “yes” selected individually time delay set of each Alarm/Protection zone will be active during night mode, if “no” selected Alarm zones will be activated immediately, the set delay will be not active. Protection zones individually time delay set will be active.

**Example (pic. above):**

BUI led 4 is set to ON (day-indicator);

Time delay of 60 sec. will be added to time delay of all Alarm zones at day mode.

During the night, there will be not add time delay activation of all Alarm zones.

During Saturday and Sunday will be active only *night* settings there won't be changing of *day* and *night* settings.

## 1.5 Night settings:



**NIGHT-DEFAULTS**

night-smoke:  ▼

night-heat:  ▼

night-logic:  ▼

*Night-smoke:* **Low; Medium or High.**

*Night-heat:* **A2R** Detector activates by temperature increasing  
**A2S** Detector do not respond below 54C

*Night-logic:* **only heat; only smoke; heat and smoke and heat or smoke.**

*Night-defaults:* settings will be active during *night* hours (after *day-length* time is over).

## 2. Panel Settings:

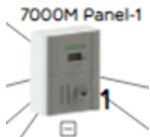

*Panel number:* panel number in CAN network. Can be set between 1-15.

*PSU type:* 160W (by default)

*Panel password:* set own password for level access 3, default – 1122. Can be between 4-16 digits long. Password is entered over functional buttons F1-F4. (Which are corresponding 1 to 4, panel password can contain only digits from 1 to 4)

*Panel label:* panel name - user text defined. Used as identification of the panel.

*panel-printer*: set *yes* if printer is attached to panel

*print-fires*: set *yes* for printing fires. This setting overrides *print-fires* setting on a system level – System-Config.

*print-faults*: set *yes* for printing faults. This setting overrides *print-faults* setting on a system level – System-Config.

*check-earth*: set *yes* to enable or *no* to disable the earth check

*FBRE delay*: set activation delay time for **Fire Brigade Routing Equipment output** after panel receives fire alarm event from any Detection zone (up to 600sec). Default – 30 seconds.

*FWRE delay*: set activation delay time for **Fault Warning Routing Equipment output** after panel receives fault event and enters Fault mode (up to 600sec). Default – 30 seconds.

*FBRE timeout*: set timeout for FBRE confirmation (up to 300 sec). Default value is set to 10 seconds.

BIO mon. Input must be set as *FBRE confirm*

*FWRE timeout*: set timeout for FWRE confirmation (up to 300 sec). Default value is set to 10 seconds.

BIO mon. Input must be set as *FWRE confirm*

## **Setting up loop devices**

Addressing of all loop devices, comes unattached to any zones. This organization task shall be completed before loading final configuration to the panel.

All Loop detectors need to be attached in new created Detection zones

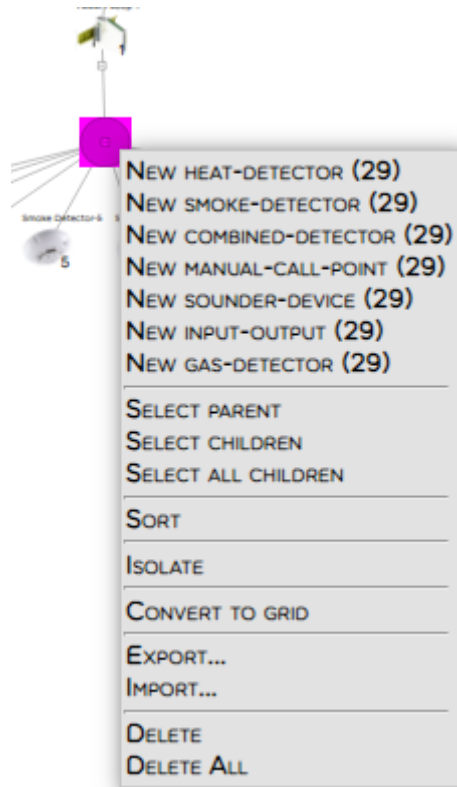

Select *Convert to grid* - all detectors will be visualized in grid structure.



Select one by one loop devices to configure. Double click on the icon of the device will open configuration form:

## 2.1 Smoke Detector -FD7130M:



**SMOKE-DETECTOR**

device-number:

device-label:

device-id:

device-blink:  **yes/no**

device-branch:  **yes/no**

smoke-sensitivity:  **low/medium/high**

detection-zone:

ri-disabled:

attached-sounder:

alarm-zone:

*device-number*: serial number of the device in the loop. This setting is automatically filled in case that the loop was addressed before configuration.

*device-label*: user text for device label. This label will be included in all events in which the device is participates – fire, fault and others.

*device-id*: unique identification factory number. Should not be change.

*device-blink*: set *yes* for blink. Device blinks periodically on every 12 seconds

*device-branch*: set to *yes* if the device is in branch connection

*smoke-sensitivity*: set smoke-sensitivity as **Low/Medium** or **High**

*detection-zone*: place the configured device as detectors or Inputs of BIO modules or I/O modules in detection zone, as set a detection zone number

*ri-disabled* - if setting is selected and checked - device remote indicator is disabled.

ri-disabled:

Remote indicator can be: LED indicator or Buzzer indicator.

*attached-sounder* - if setting is selected and checked - there is attached base sounder to the device. Base sounder 7206M

attached-sounder:

*alarm zone*: alarm zone of the base sounder.

## 2.2 Combine Detector -FD7160M:



**COMBINED-DETECTOR**

device-number:

device-label:

device-id:

device-blink:  ▼

device-branch:  ▼

heat-sensitivity:  ▼ **A2R/A2S**

smoke-sensitivity:  ▼ **low/medium/high**

sensor-logic:  ▼ **only heat/only smoke/heat and smoke/heat or smoke**

detection-zone:

ri-disabled:

attached-sounder:

alarm-zone:

*device-number*: serial number of the device in the loop. This setting is automatically filled in case that the loop was addressed before configuration.

*device-label*: user text for device label. This label will be included in all events in which the device is participates – fire, fault and others.

*device-id*: unique identification factory number. Should not be change.

*device-blink*: set *yes* for blink. Device blinks periodically on every 16 seconds

*device-branch*: set to *yes* if the device is in branch connection

*heat-sensitivity*: set heat-sensitivity depend on site fire plan:

*A2R* – Detector activates by temperature increasing

*A2S* – Detector do not respond below 54°C

*smoke-sensitivity*: set smoke-sensitivity as **Low/Medium** or **High**

*sensor-logic*: combine detector can work in those modes:

**Only heat detection** - smoke detector part does not work

**Only smoke detection** – heat detector part does not work

**Smoke or Heat detection** - combine detector goes into fire mode when either smoke or heat detector are activated

**Both** - combine detector goes into fire mode when smoke and heat detector are activated

*detection-zone*: place the configured device as detectors or Inputs of BIO modules or I/O modules in detection zone, as set a detection zone number

*ri-disabled* - if setting is:

ri-disabled:

Device remote indicator is disabled. Remote indicator can be: LED indicator or Buzzer indicator.

*attached-sounder* - if setting is:

attached-sounder:

There is attach base sounder to the device. Base sounder 7206M  
*alarm zone*:

## 2.3 Heat Detector -FD7120M:



**HEAT-DETECTOR**

device-number:

device-label:

device-id:

device-blink:

device-branch:

heat-sensitivity:

detection-zone:

ri-disabled:

attached-sounder:

alarm-zone:

*device-number*: serial number of the device in the loop. This setting is automatically filled in case that the loop was addressed before configuration.

*device-label*: user text for device label. This label will be included in all events in which the device is participates – fire, fault and others.

*device-id*: unique identification factory number. Should not be change.

*device-blink*: set *yes* for blink. Device blinks periodically on every 16 seconds

*device-branch*: set to *yes* if the device is in branch connection

*heat-sensitivity*: set heat-sensitivity depend site fire plan:

**A2R** – Detector activates by temperature increasing

**A2S** – Detector do not respond below 54°C

*detection-zone*: place the configured device as detectors or Inputs of BIO modules or I/O modules in detection zone, as set a detection zone number

*ri-disabled* - if setting is:

ri-disabled:

Device remote indicator is disabled. Remote indicator can be: LED indicator or Buzzer indicator.

*attached-sounder* - if setting is:

attached-sounder:

There is attach base sounder to the device. Base sounder 7206M  
*alarm zone*:

## 2.4 Input Output module -7203M:



**INPUT-OUTPUT**

device-number:

device-label:

device-id:

device-blink:  **yes/no**

device-branch:  **yes/no**

external-powered:  **yes/no**

control-output:  **yes/no**

default-on:

initial-delay:  **time /sec**

pulse-length:  **time /sec**

pulse-pause:  **time sec**

output-fad:   **Fire Alarm**

alarm-zone:

output-fpe:   **Fire Suppress**

protection-zone:

general-output:   **Common Purpose**

input-fire:   **Fire indication**

detection-zone:

input-fault:   **Fault indication**

input-general:   **General input**

input-pattern:  **latched/Auto input**

input-message:  **text message**

### Output activation behavior

*external powered:* if *yes*, I/O module’s relay output is powered by external power supply or powered by loop. Please follow instruction manual of 7203M for proper connection of external power supply.

*control-output:* *yes* – 7203M output works as monitored output *no* –

7203M output works as relay output;

*Default-on*: set the default state of the device output (default state is OFF)

*initial delay*: delay before activating of the output. Default: 0 – immediate activation.

*pulse-length*: time-period in which the output is active. Default: 0 – continuous activation - latched.

*pulse-pause*: time-period in which the output is inactive. Default: 0 – no pause.

For more details please read instruction manual of 7203M.

## Output type configuration

*output-fad*: output is configured as Fire Alarm Device and shall be distributed in Alarm zone

*alarm zone*: set an Alarm zone number. When alarm zone is activated from the panel, device output will be activated too

*output-fpe*: configured as Fire Protection Equipment

*protection-zone*: set a Protection zone number. When protection zone is activated from the panel, device output will be activated too

*general-output*: if configured as General output, it will be activate by logic rules.

## Input type configuration

*input-fire*: configure device input as fire device (activation of the device input will activate the set detection zone)

*detection-zone*: set device input in detection zone

*input-fault*: Activation of device input will set panel in “Fault Mode”

*input-general*: Activation of the device input will activate user defined logic rules

*input-pattern:auto* – this option monitors the input signal and according its state changes the input mode - activated or not activate. *Latched* – once activated, input stays active until reset command from the panel is received.

*input-message*: set a text for message, when is device input is activating a message text will show.

## 2.5 Addressable Sounder -7206M:



**SOUNDER-DEVICE**

device-number:

device-label:

device-id:

device-blink:  yes/no

device-branch:  yes/no

alarm-zone:

*alarm zone*: place the configured device as sounders or Outputs of BIO modules or I/O modules in Alarm zone, as set an Alarm zone number.

## 2.6 Manual Call Point -FD7150M:

If *priority-alarm* is set to *yes*, manual-call point activation set panel in fire mode. If the setting is *no*, all programmable logic (CI modes) and time delays are applicable.

**MANUAL-CALL-POINT**

device-number:

device-label:

device-id:

device-blink:

device-branch:

priority-alarm:

detection-zone:

## 2.7 Conventional line Adapter -7201M:

**CONVENTIONAL-ADAPTER**

device-number:

device-label:

device-id:

device-blink:

device-branch:

sensor-removal:

line-fire2:

line-fire1:

detection-zone:

*Sensor-removal:* if set *yes* must be used diode bases.

*line-fire2:* set value fire current for fire stage 2 – default 24 mA

*line-fire1:* set value fire current for fire stage 1 - default 14 mA

Conventional line can support up to 3 conventional detectors, needed EOL-2, (C-10 $\mu$ F; R-5,6k $\Omega$ ). Loop can support up to 5 psc. (**depends on other loop devices**) conventional adapters 7201M.

**Installation tip:** After connecting of Conventional line detectors and system 7000M is started with the configuration go to menu “Status – Components – Adapters” – choose the adaptor and press button “menu” – system will displayed the current of Conventional line. Double check it

with the settings already set in the conventional line adaptor.

**Note:** When using conventional Manual Call Point 7050, must set the current to 40mA.

**Note:** Conventional detection zones can not be part of CI-modes.

### 3. Zones

#### 3.1 Detection zones

(right click on Panel icon)

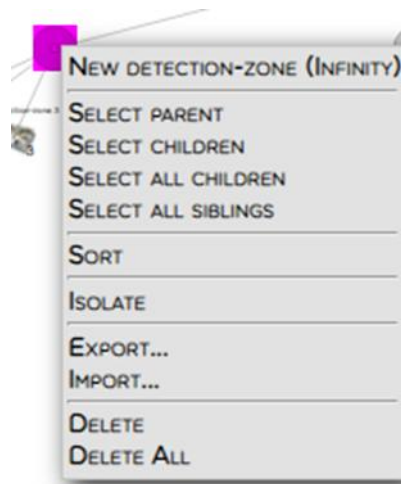
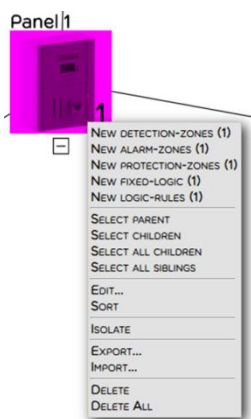

**DETECTION-ZONE**

zone-number:

zone-label:

OK CANCEL

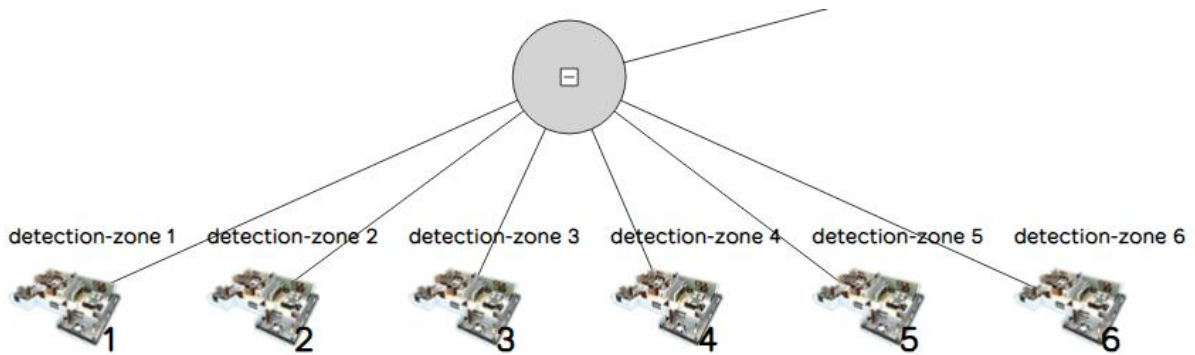

Number of D-zones per system: 1023. Each D-zone can contain up to 32 detectors, manual call points or fire inputs.

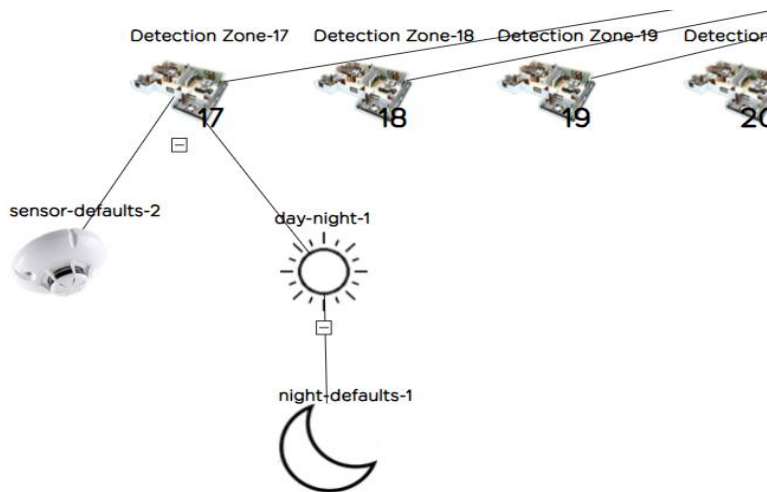

Each *Detection zone* can have independently set *day-night* and *sensor defaults* settings, that overrides global settings “*Sensor Defaults*” and “*day-night*”.

(right click on selected D-zone and add elements “*sensor-defaults*”, “*day-night*” and “*night defaults*”)

### 3.2 Alarm zones

At *A-zones* are attached sirens and Fire alarm Devices configured outputs of BIO devices and I/O loop devices. All of those outputs have to be share out according site fire plan.

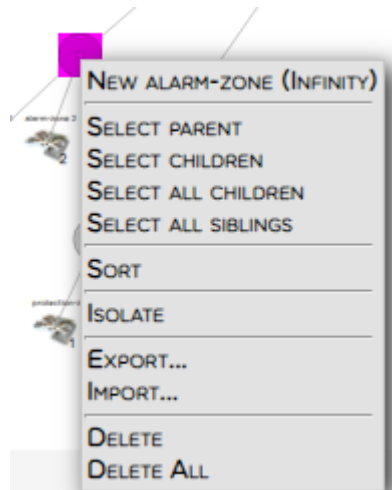

**ALARM-ZONE**

zone-number:

zone-label:

output-delay:

alarm-pattern:  ▼

warning-pattern:  ▼

Maximum output-delay activation after D-zone fire alarm event is 600 seconds.

Each *Alarm zone* can be set with different alarm sound and output delay. In that case *Sounder Default* settings will be not valid for that *A zone* and output delay will be added to value *day-delay* time at *Day-Night* settings.

Add detection zones that activates the *Alarm zone* – right click on the grey circle and select “New detection-zone”.

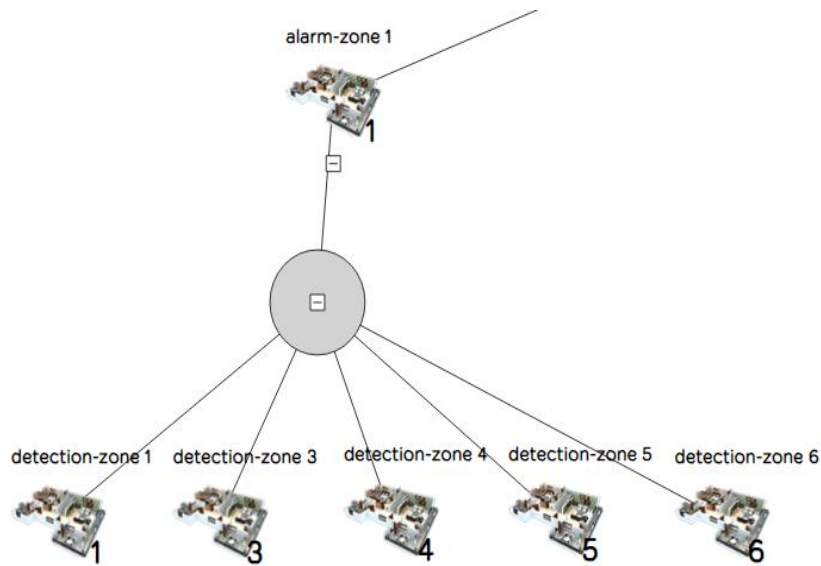

Number of A-zones per system: 1023

No limitations about maximum number of D-zones attached to A-zones.

Each A-zone can have up to 8 Next zones. Next zone will be activated with its warning sound in case of alarm activation of A-zone.

It is allowed that Alarm and Warning sound patterns to be same.

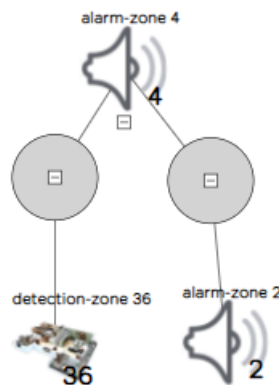

### 3.3 Protection zones

Maximum output-delay activation after D-zone fire alarm event is 600 seconds.

All Fire protection devices shall be distributed (FPE) in *P-zones* –Fire Protected Equipment of BIO I/O loop devices. When P zone is activated all grouped devices are activated as well.

Number of P-zones per system: 1023

No limitations about maximum number of D-zones attached to P-zones.

Add detection zones that activate the *Protection zone* – right click on the grey circle and select “New detection-zone”.

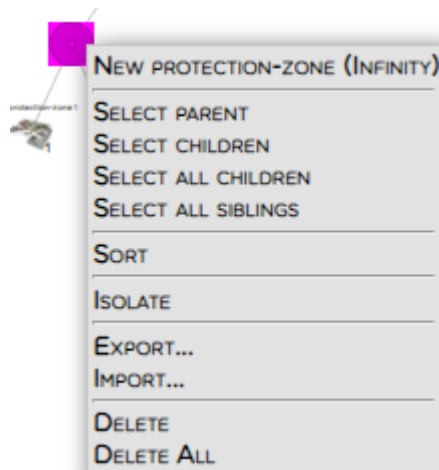

**PROTECTION-ZONE**

zone-number:

zone-label:

output-delay:

OK CANCEL

Add Detection zones to *Protection zone*.

**DETECTION-ZONE**

zone-number:

OK CANCEL



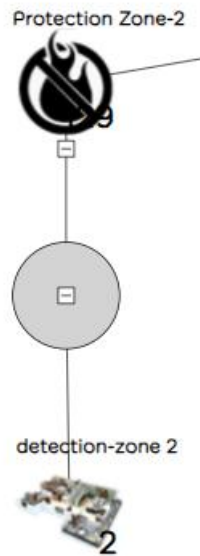

### 4. Basic Input Output (BIO) module configuration

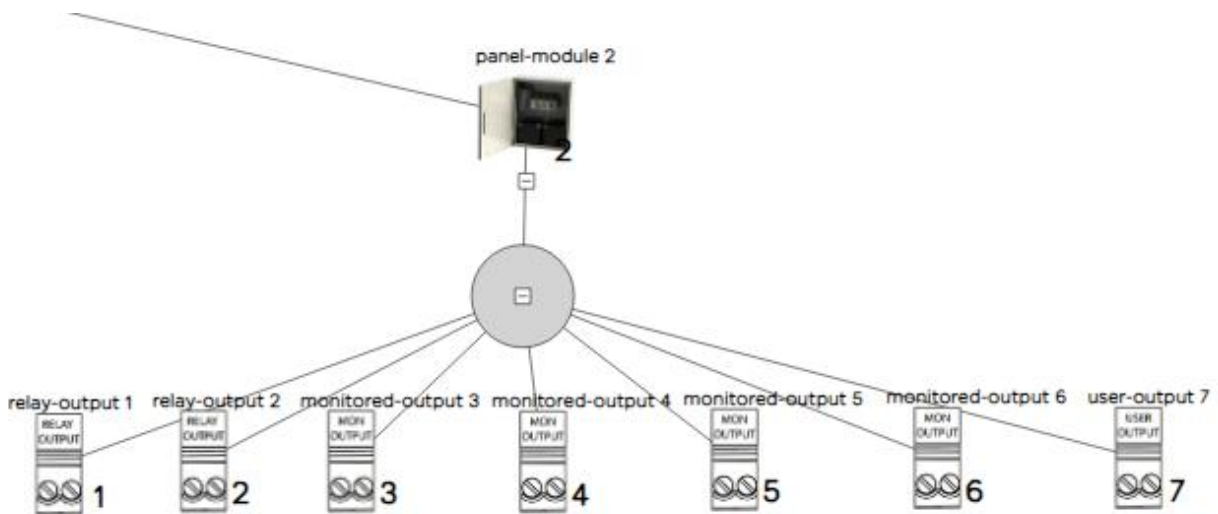

BIO module has 7 devices – 2pcs relay outputs – device 1 and 2, 2pcs monitored outputs – device 3 and 4, 2pcs monitored inputs – device 5 and 6 and 1pcs user output – device 7. All these devices shall be configured and distributed in zones or assigned as FBRE or FWRE to ensure proper configuration of BIO module.

## 4.1 Relay Output 1/2– BIO device 1/2:

The screenshot shows the 'RELAY-OUTPUT' configuration window. At the top, there is a small icon of a relay output device labeled 'relay-output 1'. Below the icon, the configuration fields are as follows:

- device-number:
- device-label:
- output-fad:  (dropdown menu)
- alarm-zone:
- output-fpe:  (dropdown menu) with a radio button and a red arrow pointing to the text 'Fire Suppress'.
- protection-zone:
- output-common:  (dropdown menu) with a radio button and a red arrow pointing to the text 'Common purpose'.
- default-on:

At the bottom of the dialog are 'OK' and 'CANCEL' buttons.

Relay output device is non-potential switching device.

*device-number*: always set relay output pos. 1 to device number 1 and relay output pos. 2 to device number 2;

*device-label*: set user defined device label – up to 34 symbols;

*output-fad*: set BIO device output as Fire Alarm Device:

- *alarm-zone*: distribute device in alarm zone. Selected alarm zone that activates relay output;

*output-fpe*: set BIO device output as Fire Protection Equipment:

- *protection-zone*: distribute device in protection zone. Selected protection zone activates relay output;

*output-common*: set BIO device to be activated by Logic rule (see Chapter 7 Script Configuration);

*default-on*: set the default state of the device relay (default state is OFF);

## 4.2 Monitored Output 3/4 – BIO device 3/4:



**MONITORED-OUTPUT**

device-number:

device-label:

output-fad:

alarm-zone:

fad-feature:

output-fpe:

protection-zone:

fpe-feature:

output-fbre:

fbre-feature:

output-fwre:

fwre-feature:

output-common:

default-on:

output-feature:

Monitored Output device is potential switching device with creepage and fault control. This type of output can be programmed as Fire Alarm Device (output-fad), Fire Protection Equipment (output-fpe), Fire Brigade Routing Equipment (output-fbre)<sup>1</sup>, Fault Warning Equipment (output-fwre)<sup>2</sup>. Radio button is used for selection of the desired output type.

<sup>1,2</sup> This output type can be configured only in last BIO module device 3 for FBRE and device 4 for FWRE

**Note:** In case that the panel enters System fault and Fire event is registered at that moment than device 3 in all BIO modules will be activated automatically (hardware designed) regardless the current output configuration. Recommended configuration for Monitored output is output-fbre (if required), output-fad or output-fpe.

This output need to be calibrated after its first start after configuration (menu Service/Calibration). Output can be calibrated only in case that the

EOL and load are connected properly without any detected faults from the module.

*device-number*: always set mon. output pos. 3 to device number 3 and mon. output pos. 4 to device number 4;

*device-label*: set user defined device label – up to 34 symbols;

*output-fad*: set BIO device output as Fire Alarm Device:

- *alarm-zone*: distribute device in alarm zone. Selected alarm zone that activates the monitored output;
- *fad-feature* – select EOL type that has to be used:
  - if C-EN54-2 option is selected, 1.5k termination resistor needs to be connected at the end of the line of the monitored output.
  - if EOL-EN54-13 option is selected, special EOL element shall be used to ensure requirements according EN54-13 (can be ordered on special client request. Not part of the regular equipment of the BIO module);

*output-fpe*: set BIO device output as Fire Protection Equipment:

- *protection-zone*: distribute device in protection zone. Selected protection zone activates the monitored output;
- *fpe-feature*:
  - if G-EN54-2 option is selected, 1.5k termination resistor is needed to be connected at the end of the line of the monitored output.
  - if EOL-EN54-13 option is selected, special EOL element shall be used to ensure requirements according EN54-13 (can be ordered on special client request. Not part of the regular equipment of the BIO module);

*output-fbre*: set BIO device output as Fire Brigade Routing Equipment. Output will be activated when the panel enters “Fire Mode” and configured fbre-delay from system-panel has expired:

NOTE:

- *fbre-feature*:
  - if E-EN54-2 option is selected, 1.5k termination resistor is needed to be connected at the end of the line of the monitored output.
  - if EOL-EN54-13 option is selected, special EOL element shall be used to ensure requirements according EN54-13 (can be ordered on special client request. Not part of the regular equipment of the BIO module);

*output-fwre*: set BIO device output as Fault Warning Routing Equipment  
This output is always energized when panel is in Normal mode – no active faults. In case of any fault received in the panel or in the panel network, output will be de-energized after fwre-delay from system-panel has expired.

*fwre-feature*:

- if J-EN54-2 option is selected, 1.5k termination resistor is needed to be connected at the end of the line of the monitored output.
- if EOL-EN54-13 option is selected, special EOL element shall be used to ensure requirements according EN54-13 (can be ordered on special client request. Not part of the regular equipment of the BIO module);

*output-common*: set BIO device output to be activated by Logic rule (see Chapter 7 Script Configuration);

- *default-on*: set the default state of the BIO device (default state is OFF);
- *output-feature*: meaningless parameter;

### 4.3 Monitored Input 5/6 – BIO device 5/6:

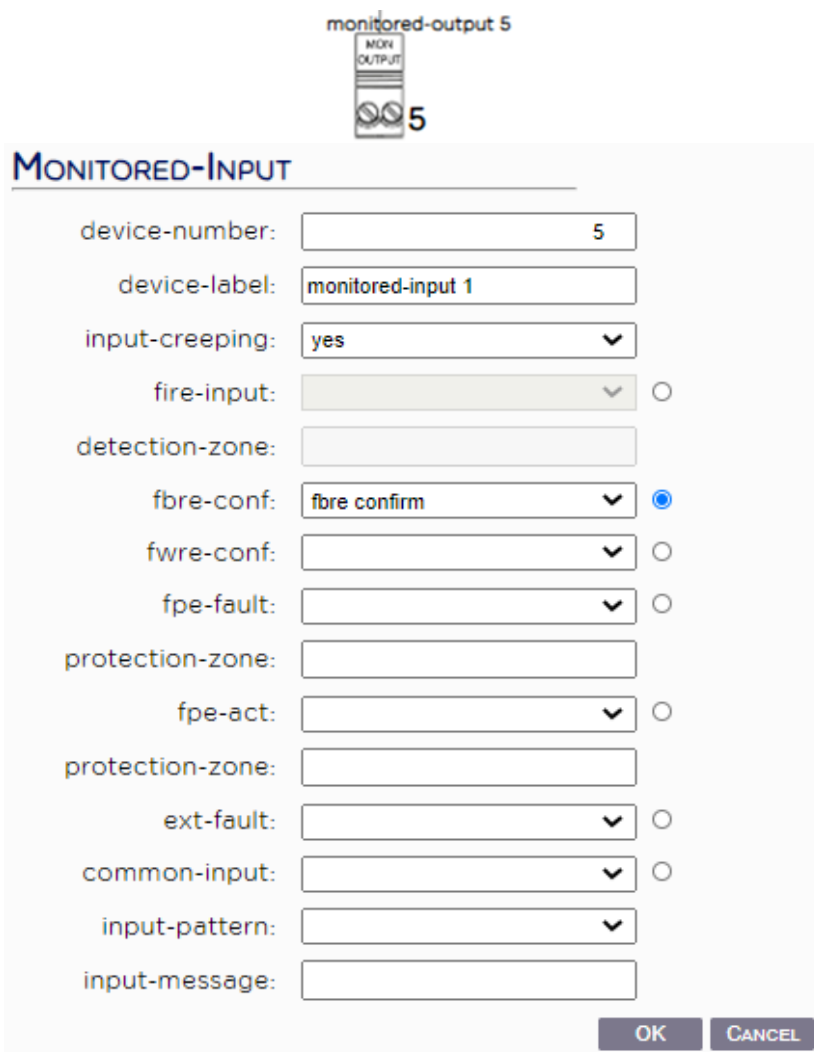

monitored-output 5

MON  
OUTPUT  
5

**MONITORED-INPUT**

device-number:

device-label:

input-creeping:  ▼

fire-input:  ▼

detection-zone:

fibre-conf:  ▼

fwre-conf:  ▼

fpe-fault:  ▼

protection-zone:

fpe-act:  ▼

protection-zone:

ext-fault:  ▼

common-input:  ▼

input-pattern:

input-message:

OK CANCEL

Monitored Input device is part of BIO device set and has 2 pcs inputs. Input can be configured as fire device input, fibre confirmation input, fibre confirmation input, fibre activation confirmatory input, fibre fault input.

*device-number*: always set mon. input pos. 5 to device number 5 and mon. input pos. 6 to device number 6;

*device-label*: set user defined device label – up to 34 symbols;

*input-creeping*:

- *yes* - check resistance of cables connected is active, by the time if this resistance has changed a notification message will appear on the panel;

- *no* – input is monitored only for faults – open load and short circuit;

*fire-input*: configure device input as fire device (activation of the device input will activate detection zone):

- *detection-zone*: distribute device in detection zone. Selected detection zone will be activated in case of fire input activation;

*fbre-conf*: Option for Fire brigade confirmation input. After activation of FBRE output, a confirmation input can be created. Confirmation input is activated from remote equipment and confirms that the signal from FBRE output has been received. A timeout for confirmation of receiving confirmation signal can be set –*fbre-timeout* from system-panel setting. In case of no confirmation of the remote side a fault for FBRE confirmation will arise.

*fwre-conf*: Option for Fault warning routing equipment confirmation input. After activation of FWRE output, a confirmation input can be created. Confirmation input is activated from remote equipment and confirms that the signal from FWRE output has been received. A timeout for confirmation of receiving confirmation signal can be set –*fwre-timeout* from system-panel setting. In case of no confirmation of the remote side a fault for FWRE confirmation will arise.

*fpe-fault*: Option for configuring confirmation input for fault indication in protection zone. Monitored input shall be activated remotely from a fault monitoring device:

- *protection-zone*: set protection zone number which is monitored;

*fpe-act*: Option for configuring FPE confirmation activation input. Input will confirm activation of BIO mon. Output set as Fire Protection Equipment.

- *protection-zone*: set protection zone number which shall be confirmed;

*ext-fault*: Option for configuring monitored input as device reporting fault in external monitored device. Activation of this input will enter panel in Fault mode;

*common-input*: Activation of the BIO device input will be activate by *logic rule*.

- *input-pattern*:  
*auto* – considered as activated or deactivated depending on the monitored input stimulus.  
*latch* – once activated, input stays in activated mode without further monitoring the state of the input;
- *input-message*: set a text message which will appear in case of appearing / disappearing event from common-input device;

## 4.4 User Output 7 – BIO device 7:



**USER-OUTPUT**

device-number:

device-label:

output-user:

default-on:

activation-delay:

activation-duration:

repeat-delay:

activation-trigger:

User output device is powerful non-controllable potential output.

Can be used as general-purpose output which is activated during different events.

*device-number*: always set user output pos. 7 to device number 7;

*device-label*: set user defined device label – up to 34 symbols;

*default-on*: when this option is selected – output will be energized in its inactive state and will be de-energized until its activation;

A different control parameter can be used to control output behavior:

*activation-delay*: delay for activating of the user output. Maximum delay 600 sec.;

*activation-duration*: time period in which the user output is in active state;

*repeat-delay*: time period in which the output repeats programmed pattern;

*activation-trigger* events: Choose event that activates user output - *fire enter*; *fire leave*; *fault enter* and *fault leave*;

## 5. Fixed logic – Coincidence (CI) modes settings:

(right click on panel icon)

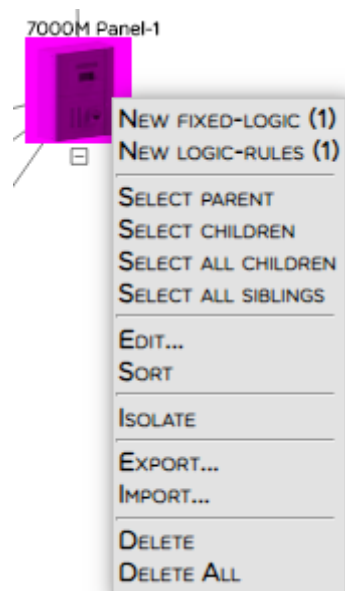

Right click on the created fixed logic node and select needed mode – CI-mode type A, CI-mode type B or CI-mode type C according EN54-2 p.7.12 – Dependencies on more than one alarm signal. More information

about CI functionalities please refers p.6 Coincidence modes from 7000M Instruction Manual.

**Note:** Conventional detection zones can not be part of CI-modes.

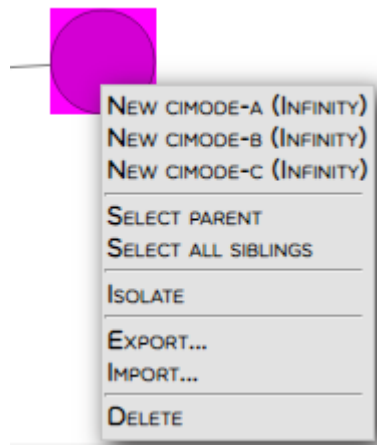

## 5.1 CI-mode A:



Fire detector from the selected detection zone detects fire, after 60 sec. the detector will be reset automatically and then start running programmable *fire-timeout*. During this time if the same detector or other detector from the same detection zone detects fire, the panel enter “Fire mode”.

If the time *fire-timeout* is run over and there is not detected a fire the *CI-mode A* logic is reset.

Alarm and Protection zones/outputs will be activated when CI-A is activated the Panel is in “Fire Mode” without time delay, however is programmed as output-delay.

## 5.2 CI-mode B:

**CIMODE-B**

fire-timeout:

alarm-silent:

OK CANCEL

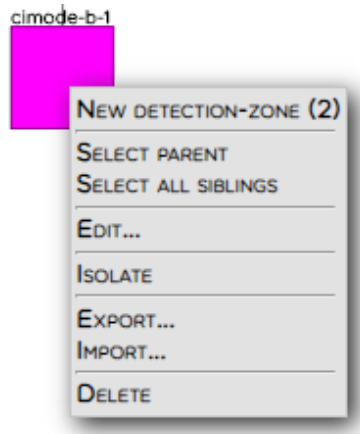

**DETECTION-ZONE**

zone-number:

OK CANCEL

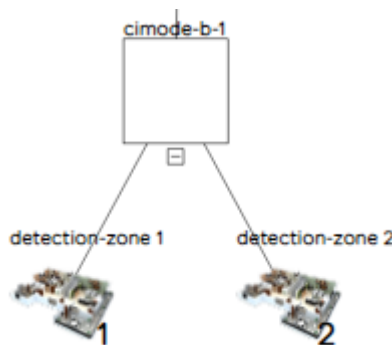

Select one or two detection zones working in CI mode B together. First alarm from some of the detection zones will enter panel in Pre-alarm state.

The duration of this state is defined by *fire-timeout* – investigation time for confirming fire alarm event. In case that the event is confirmed – all alarm zones change/start its notification sound to Alarm.

The corresponding Alarm zone can be activated with configured *warning-pattern* during Pre-alarm state in case that *alarm-silent* parameter is set to *yes* from the CI-B mode settings.

In case that the fire is not confirmed – panel enters Normal mode;  
In case that the fire is confirmed – panel enters Fire mode and activates corresponding Alarm zones with configured *alarm-pattern*.

Alarm and Protection zones/outputs will be activated when CI-B is activated the Panel is in “Fire Mode”, without time delay (however is programmed as output-delay).

### 5.3 CI-mode C:

**CIMODE-C**

unlimited-delay:

inspection-delay:

**DETECTION-ZONE**

zone-number:

Add two detection zones which will be with *CI-mode C* logic.

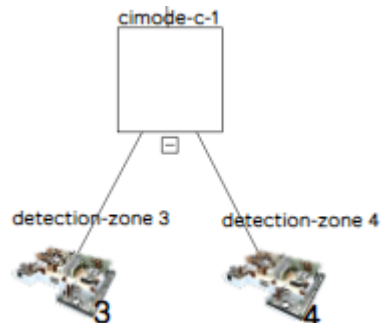

If one of the two detection zones is activated, panel goes in fire mode, sounders are not active until *inspection-delay* (exp. 300sec.) does expire or second fire does appear.

During *inspection-delay* a panel button *Investigate time* can extend delay up to 600 seconds with 60 seconds delay.

In case that the *unlimited-delay* parameter is set to *yes* each press of button will increase *inspection-delay* time with 60 sec., and up to 600 sec. *Unlimited-delay* is set to *yes*, pressing button *Inspection* will increase *inspection-delay* time to unlimited.

Alarm zones/outputs will be activated when CI-C mode is activated the Panel is in “Fire Mode”, without time delay however is programmed as output-delay, Protection zones/outputs will be activated after end of output-delay and day-delay if calendar mode is active.

**Note:** Detection zones involved in CI-C should be the only triggering A/P zones. It does not allow any other D-zones activating these A /P zones

## 6. Repeater configuration (BUI and BUI1 devices)\*

\*BUI – basic user interface

Control panel and its zonal indication usually come in the configuration after first addressing of the panel.

Each panel can have up to 15 Repeaters (7000M+ and 7000M) and up to 64 zonal indications configured as local zonal indications (7000M+ only).

Control panel is indicated from element *panel-bui* always represented from *bui-number 0*. Please note that the BUI numbers in the system configuration should match with the address set by the 4 position DIP switch inside the BUI repeaters.

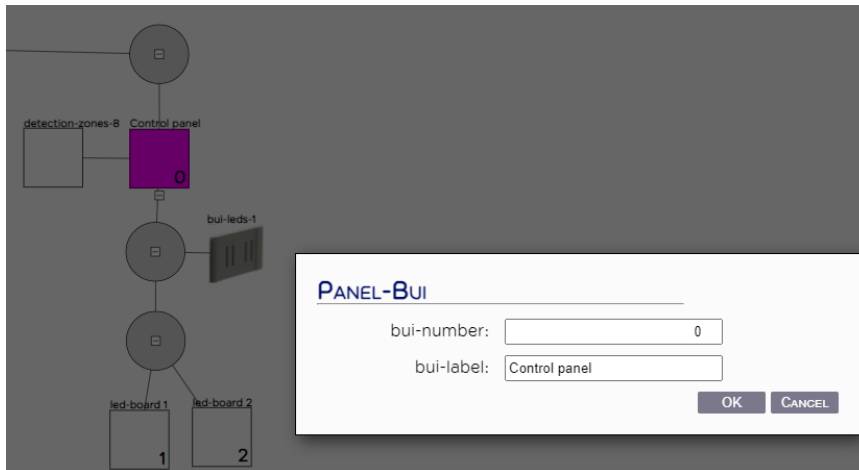

Typically panel comes with one (when panel is purchased with printer module) or two sets of zonal indications (*led-boards*). One set covers 32 zones.

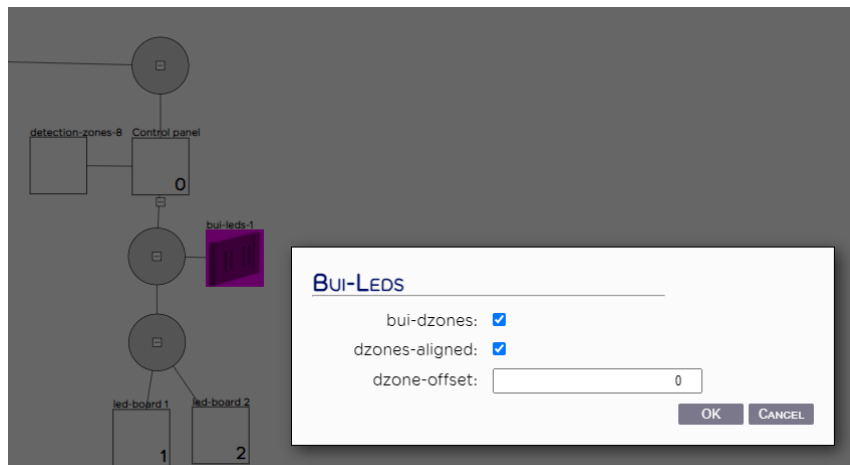

Zonal indication is a sub-element of *panel-bui* element and is indicated with *bui-leds* elements and *led-board*.

*bui-leds* – all

- *bui-dzones* – *yes* – Zone indications are follow Control Panel zones;  
*no* – Zone indications does not follow Control Panel zones;
- *dzones-aligned* – means that the indicated zones will be consecutive;
- *dzone-offset* – set zone offset for

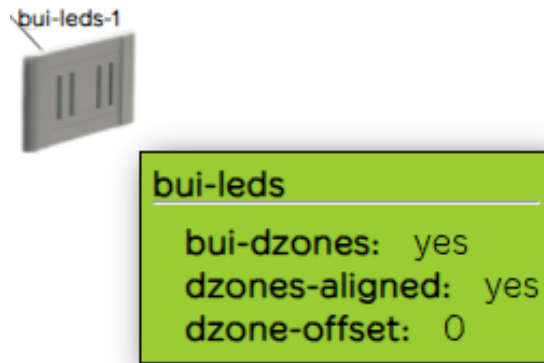

Additionally can be purchased only RS485 addressing PCB with cable set for the purposes of zonal extender connection only.

Possible addresses from 1-15.

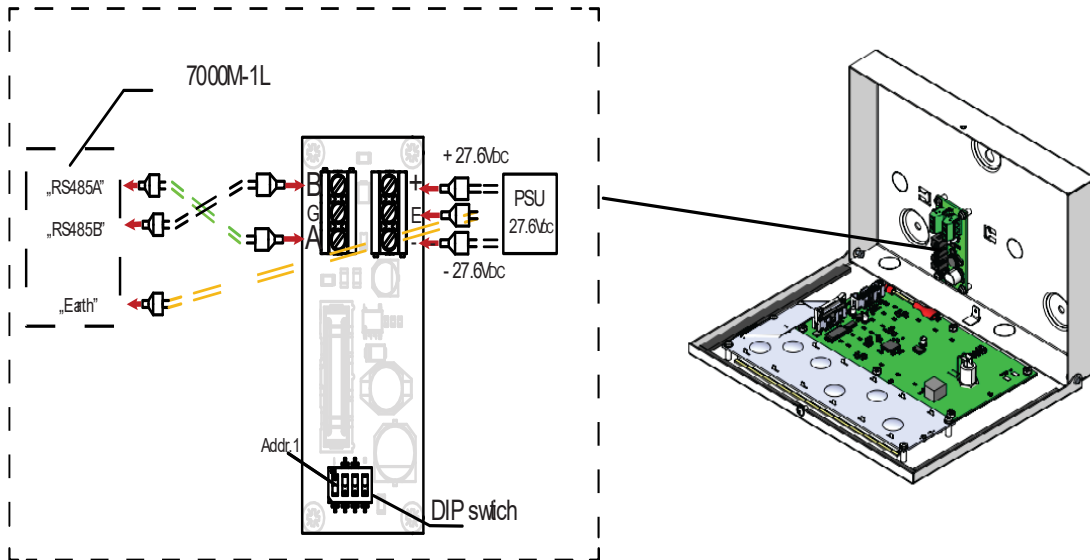

Element *detection-zones* have *panel-dzones* option – always checked (yes).

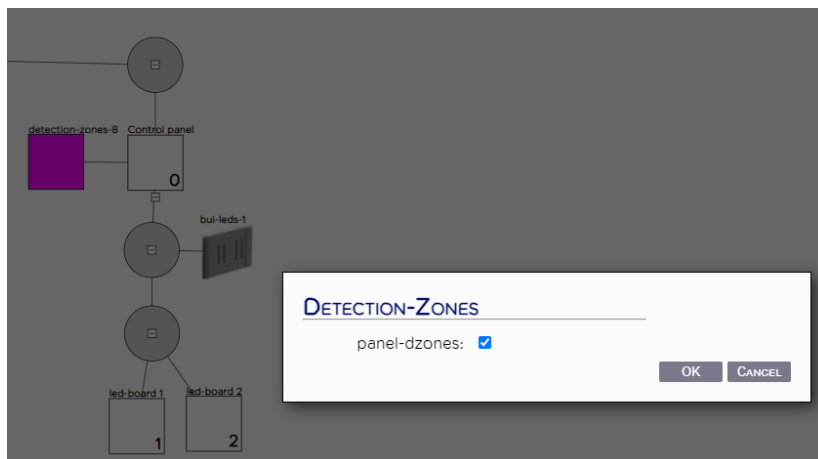

**Adding new BUI panel as repeater:**

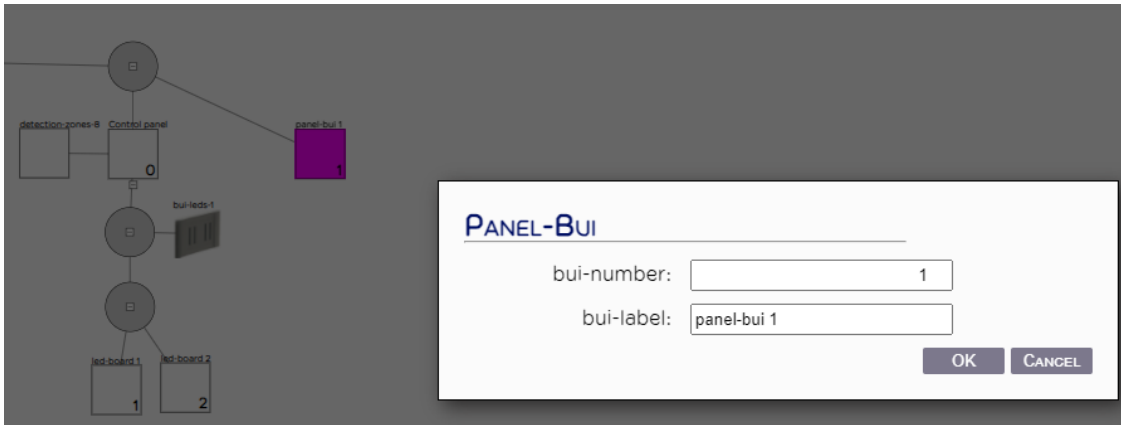
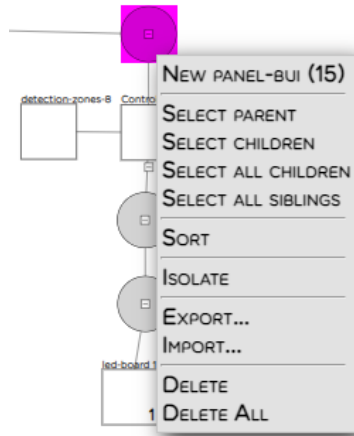

*bui-number* - set same number as the configured address;

*bui-label* - user label (text) can be up to 34 symbols;

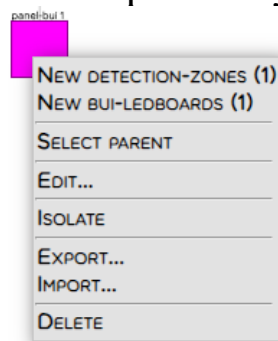

*panel-dzones* shall be checked for all BUI elements.



## 7. Script configuration

Systems 7000M+ and 7000M provides a very flexible feature that allows user to design its own script logics that can be executed independently from the base algorithms of the fire alarm control panel.

**Please note that integrator of the script logic is fully responsible to the rule behavior and UniPOS does not bear any responsibility in case that some logic is in contradiction with EN54-2 or EN54-4 standards!**

All Control Panel comes without any programmed logic.

Ideology is based on a simple rule - if something happens (becomes TRUE) than execute some action (DO that). Reset if the SET rule is not valid anymore or something other happens.

System can support up to 500 custom defined rules!

To create a new logic rule right click on the control panel icon where rule shall take effect: New logic-rule->New rule-def

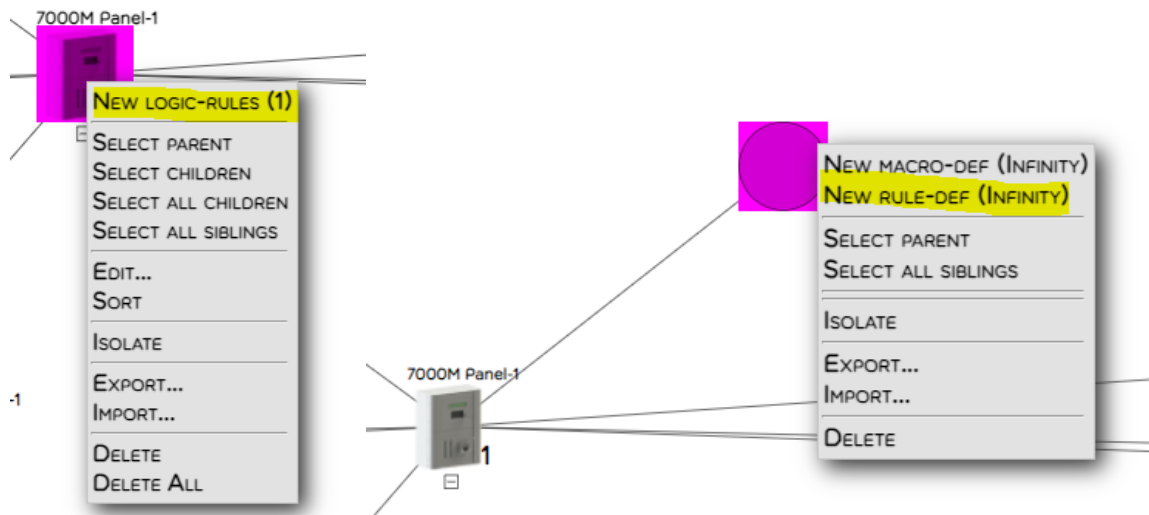

**RULE-DEF**

rule-number:

rule-name:

rule-disabled:

rule-message:

macro-call:

scripts:

```
OccursIf ( ... . DZone ( 17 ) x )
OccursAction (
...
  Activate ( BioDevice ( 2 , 1 ) x ) x .
  Activate ( LED ( non-blinking . red . 6 ) x ) x .
...
)
ResetIf ( ... , Reset x )
ResetAction ( Reset x , ... )
```

Z17:AM2B1.AR6;R;R

OK CANCEL

*rule-number*: number of the rule

*rule-name*: rule user label

*rule-disabled*: can be “yes” – rule will be not executed  
 “no” – rule is active

*rule-message*: rule message text. When rule is executed in Menu “Messages” will appear rule message text.

*macro-call*: not used

*Occursif*: Choose from dropdown menu activation event.

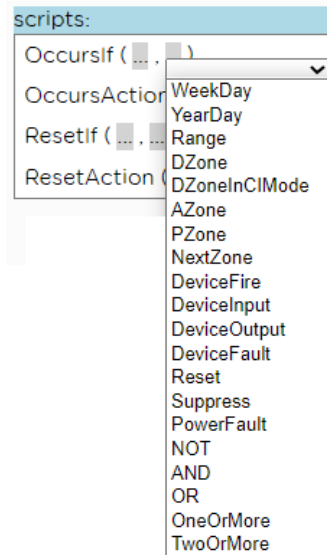

**Example:**

In *OccursIf* field, choose D-zone. Then select the number of Detection zone from drop down menu. When D-zone is in fire, rule will start execution of *OccursAction* statement.

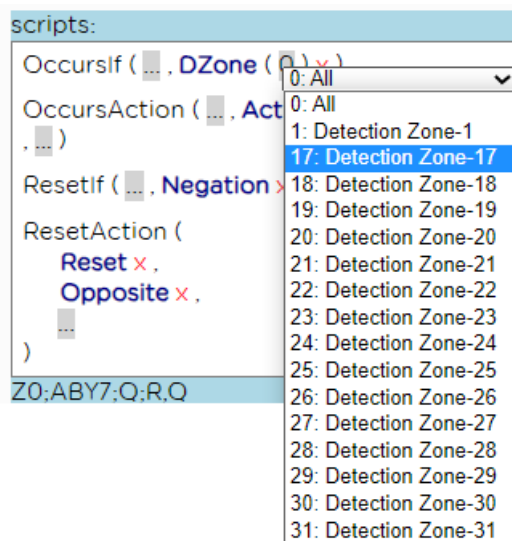

**OccursAction:** This will happen when D-zone 17 is in fire.

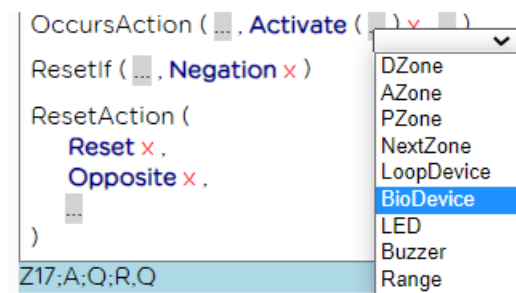
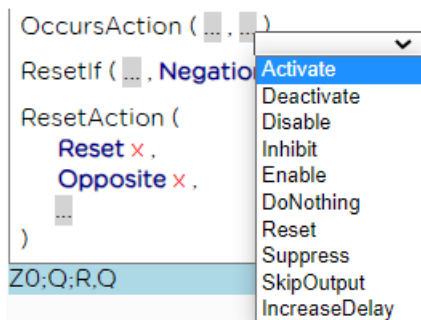

```
OccursAction ( ..., Activate ( BioDevice ( 0 ) x ) x , ... )
ResetIf ( ..., Negation x )
ResetAction (
    Reset x ,
```

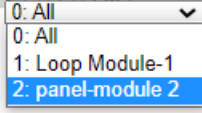

**Activate** BIO module (panel module 2 – user label)

```
OccursAction ( ..., Activate ( BioDevice ( 2 , 0 ) x ) x , ... )
ResetIf ( ..., Negation x )
ResetAction (
    Reset x ,
    Opposite x ,
    ...
)
```



Then select the BIO device you wish to activate - in the shown example is selected “*relay-output 1*”.

There is an option to add more **OccursActions** - LED 6 on the keypad of the panel:

```
Activate ( BioDevice ( 2 , 0 ) x ) x ,
Activate ( LED ( non-blinking , yellow , 1 ) x ) x ,
...
```

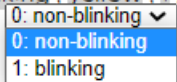

**Choose:** blinking or non-blinking

```
Activate ( BioDevice ( 2 , 0 ) x ) x ,
Activate ( LED ( non-blinking , yellow , 1 ) x ) x ,
...
```

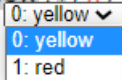

**Choose:** red or yellow color

```
Activate ( BioDevice ( 2 , 0 ) x ) x ,
Activate ( LED ( non-blinking , red , 7 ) x ) x ,
...
```

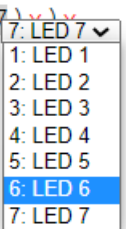

**Choose:** LED number

**ResetIf:** select from the dropdown menu reset event – *Reset*.

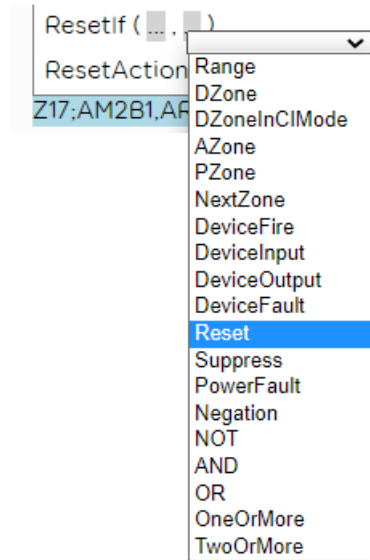

**ResetAction:** reset action could be more than one event depend from fire scheme.

ResetAction: *Reset* and *Opposite*.

That mean all *OccursActions* will be stopped due to Reset Fire event from the control panel.

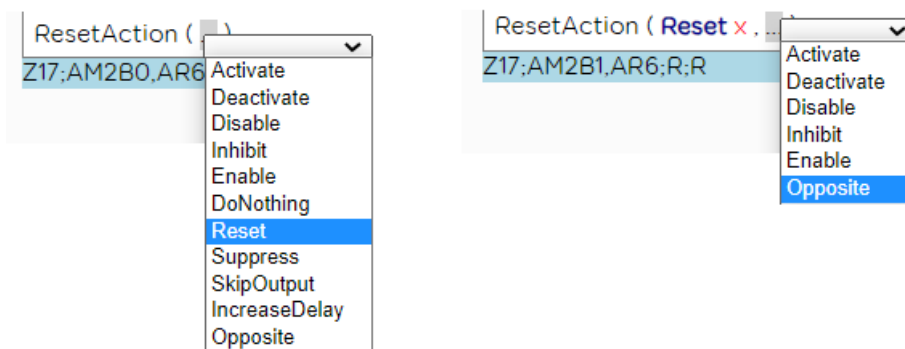

After the script is ready automatically UniConfig’s validator checks it for wrong syntax.

**Short scenario:**

Activating of D-zone 17 will activate BIO Relay 1 and LED diode 6 of keypad as non-blinking. Then in menu “Messages” will display “Test BIO Relay”

Script will be reset if panel resets.

**8. Conventional line DIN8CL module. (Available only for system 7000-1MC)**

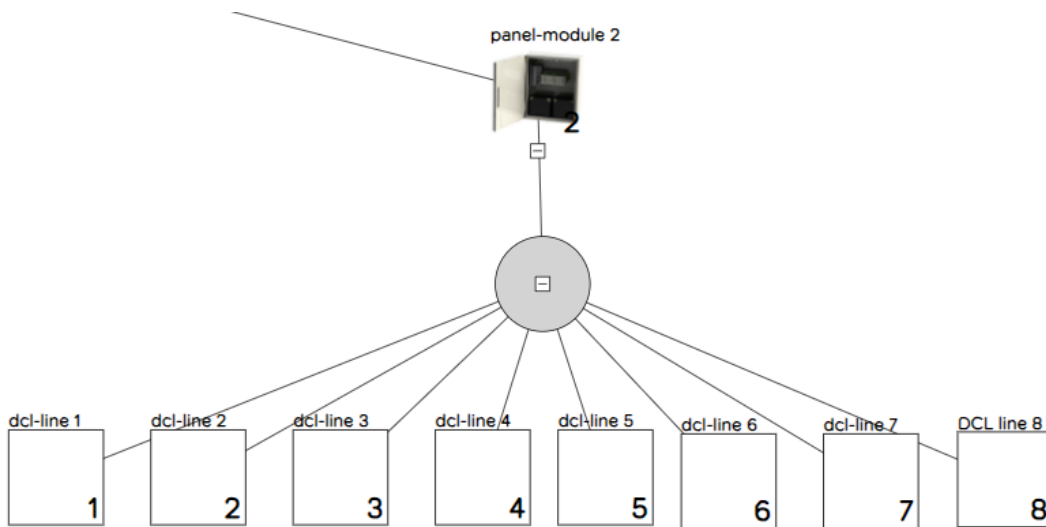

**DCL-LINE**

line-number:

line-label:

number-checks:

sensor-removal:

line-short:

line-fire2:

line-fire1:

line-open:

detection-zone:

Conventional module contains 8 inputs. Every Input can have up to 32 pcs conventional detectors.

Conventional line is pre-configured:

*Line number* – number of the line

*Line label* – user label

*Number-checks* – number of resets of the zone before enter fire state.

number-checks:  - equiqal to CI-modeA (double knock)

*Sensor removal* – if “yes” there is need to be place a shottky diode on the detector base and EOL at the end of the line. If detector is removed panel displays it in menu messages.

If “no” line needs only 3kohm for end of line termination.

Line-short: set the comsuption of the line in mA before goes in fault.

Line-fire 2: set the line current before goes on Fire mode

Line –fire1: set the line current before goes in Pre Fire

Line – open: set the current in line before goes on Fault

**Note 1:** Please do not change pre set parameters **line-short, line-fire, line-fire2, line fire1 and line-open.**

**Note 2:** Conventional D-zones are forbidden to be part of Fixed Logics (CI-modeA; CI-modeB and CI-modeC).

*Detection-zone:* set conventional line detection zone

## 9. Minimal Configuration

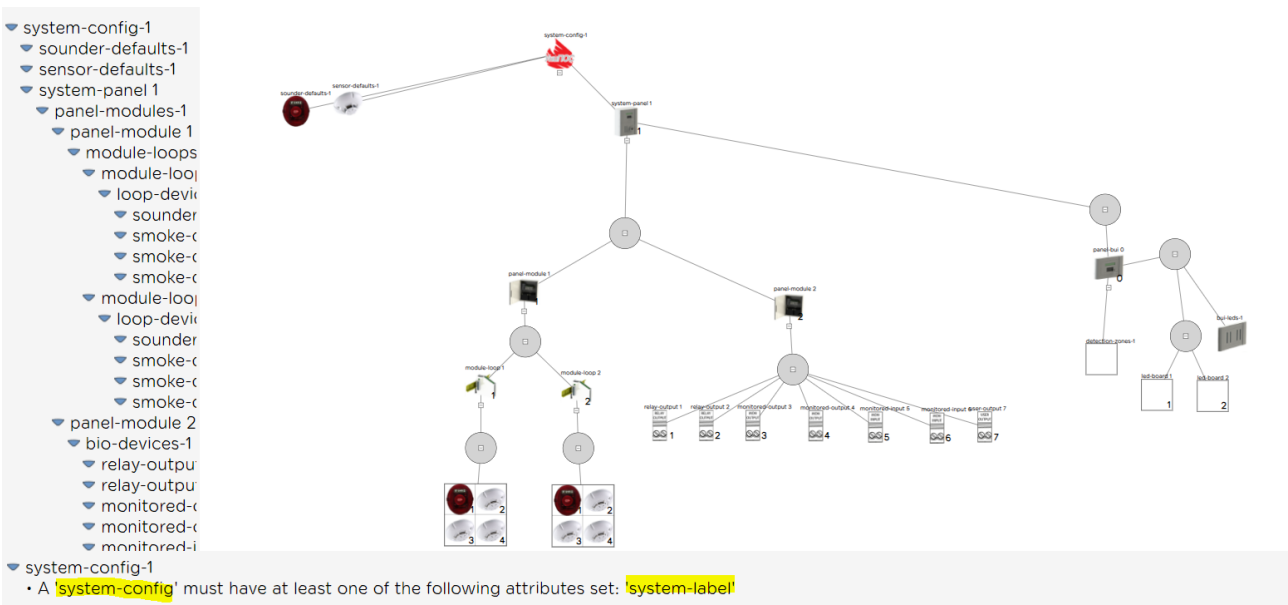

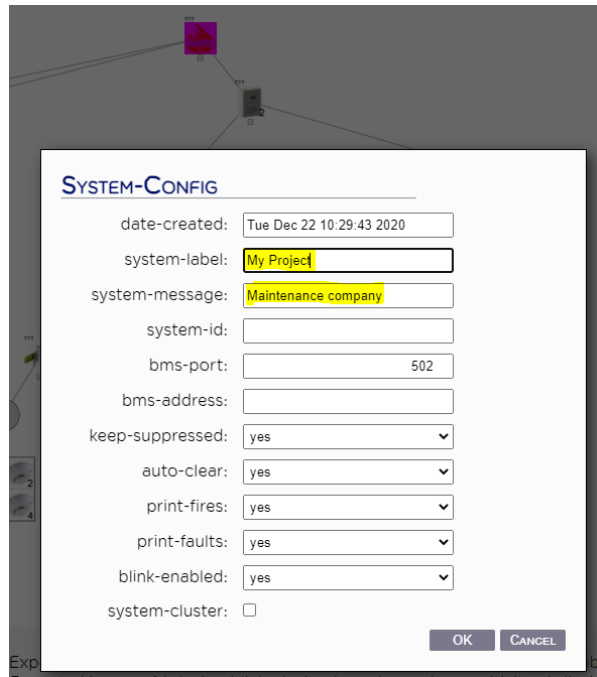

**SYSTEM-CONFIG**

date-created: Tue Dec 22 10:29:43 2020

system-label: My Project

system-message: Maintenance company

system-id:

bms-port: 502

bms-address:

keep-suppressed: yes

auto-clear: yes

print-fires: yes

print-faults: yes

blink-enabled: yes

system-cluster:

OK CANCEL

- From *System-Config* set *system-label* and *system-message* elements

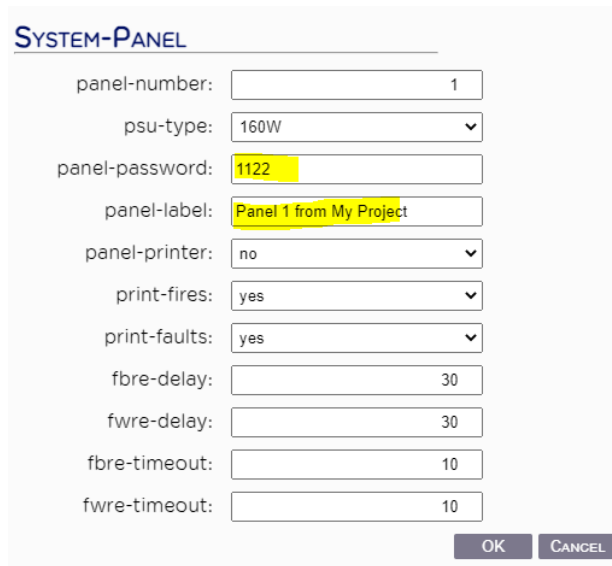

**SYSTEM-PANEL**

panel-number: 1

psu-type: 160W

panel-password: 1122

panel-label: Panel 1 from My Project

panel-printer: no

print-fires: yes

print-faults: yes

fbre-delay: 30

fwre-delay: 30

fbre-timeout: 10

fwre-timeout: 10

OK CANCEL

- From *System-Panel* set element *panel-password* and *panel-label*

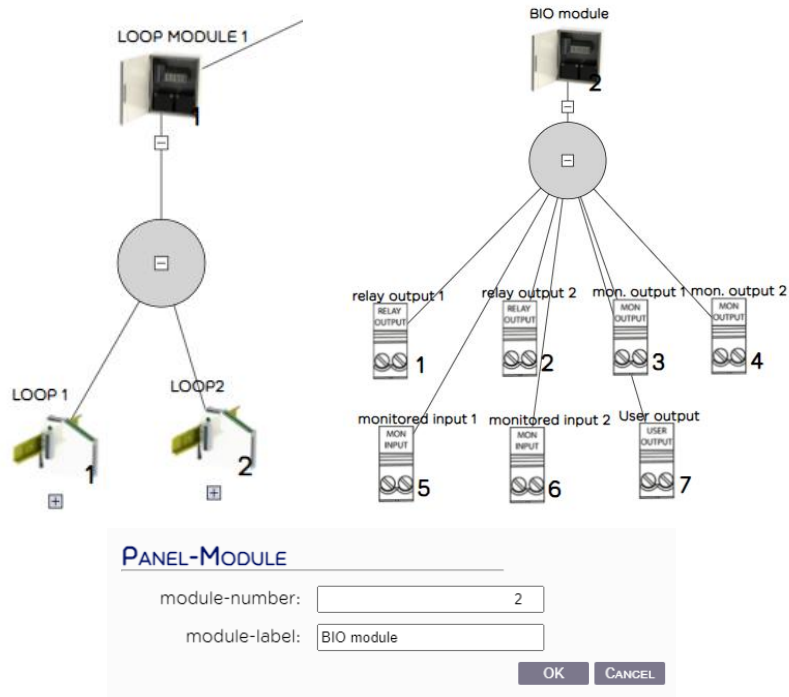

- Set *Panel-Module* labels and device labels of BIO module

- As minimum assign *detection-zones* and *device-labels* to all sensor elements – *smoke-detector*, *heat-detector*, *combined-detector*, *manual-call-point*, *input-output* and *gas-detector*;

**SOUNDER-DEVICE**

device-number:

device-label:

device-id:

device-blink:

device-branch:

alarm-zone:

- As minimum assign *alarm-zone* and *device-label* to all *Sounder-Device* elements;
- Creation of Detection zone, Alarm zone, Protection zone

Select panel of icon, right click and create *detection-zone*, *alarm-zone* and *protection-zone* elements. In our example we are considering configuration without Protection zones.

Please note that for purposes of configuring BIO device all set *detection-zone*, *alarm-zone* and *protection-zone* shall be different from those of loop devices - in our example *alarm-zone* 3 and *detection-zone* 3.

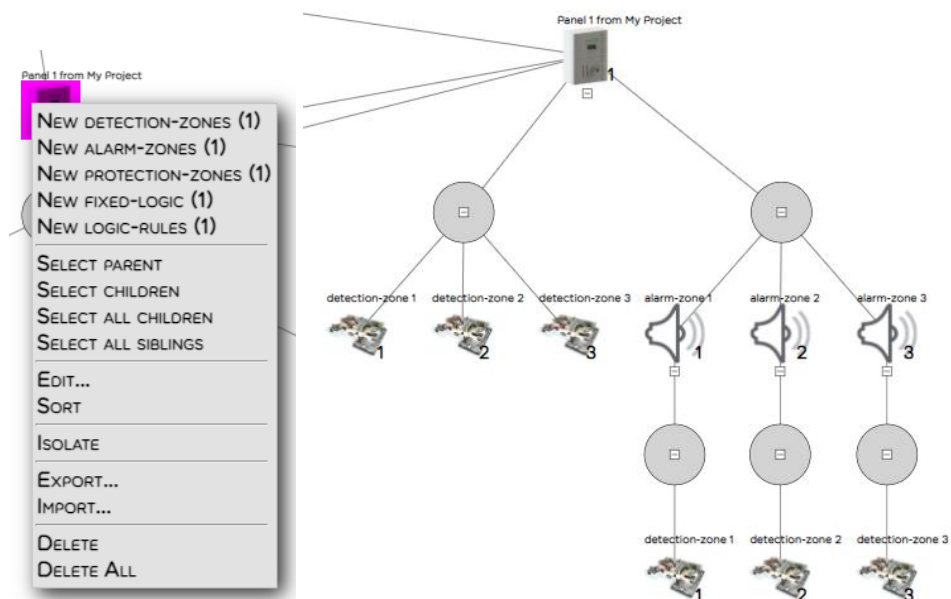

- Configuring BIO devices

*Relay-Output* - selected for *common-purpose* output – this setting will allow this output to be used from Script logic

**RELAY-OUTPUT**

device-number:

device-label:

output-fad:

alarm-zone:

output-fpe:

protection-zone:

**output-common:**

default-on:

OK CANCEL

*Monitored-Output* - selected for *output-fad* (fire alarm device), *fad-feature* – selects EOL element type and *alarm-zone* from where the output will be activated

**MONITORED-OUTPUT**

device-number:

device-label:

output-fad:

alarm-zone:

fad-feature:

output-fpe:

protection-zone:

fpe-feature:

output-fbre:

fbre-feature:

output-fwre:

fwre-feature:

output-common:

default-on:

output-feature:

*Monitored-Input* - selected for *fire-input* and set *detection-zone* that will be activated after fire input triggering

**MONITORED-INPUT**

device-number:

device-label:

input-creeping:

fire-input:

detection-zone:

fbre-conf:

fwre-conf:

fpe-fault:

protection-zone:

fpe-act:

protection-zone:

ext-fault:

common-input:

input-pattern:

input-message:

When all is set press “Validate” button to check configuration.



In case of any error you will have information about the error at the bottom part of the configurator

In the shown case below you can see that alarm-zone 1 haven't assigned detection-zone

My Project

- sounder-defaults-1
- sensor-defaults-1
- day-night-1
- night-defaults-1
- My Project
  - detection-zones-1
    - detection-zone
    - detection-zone
    - detection-zone
  - alarm-zones-1
    - alarm-zone 1
    - alarm-zone 2
    - detection-zor
    - alarm-zone 3
    - detection-zor
    - detection-z
  - panel-modules-1

My Project

Dzone 1 has no A/Pzone and is not referenced by rule  
Dzone 1 check fails for loop 1  
Module 1 config check fails for panel 1

After assigning detection zone 1 to alarm zone 1

My Project

- sounder-defaults-1
- sensor-defaults-1
- Panel 1 from My Project
  - panel-modules-1
  - panel-buis-1
  - detection-zones-1
    - detection-zone 1
    - detection-zone 2
    - detection-zone 3
  - alarm-zones-1
    - alarm-zone 1
      - detection-zones-5
        - detection-zone 1
    - alarm-zone 2
      - detection-zones-3
        - detection-zone 2
    - alarm-zone 3
      - detection-zones-4
        - detection-zone 3

UNICONFIG

Validation succeeded

OK

Then save your configuration xml and upload it into the Control Panel

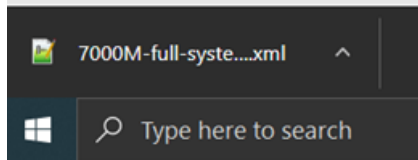
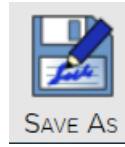

## 10. PC Regional Setting:

There is need to be checked *UTF-8 Unicode language support*

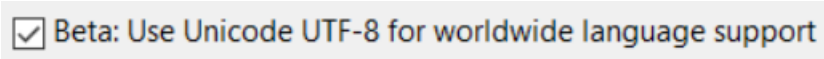

Location: “*Region*”

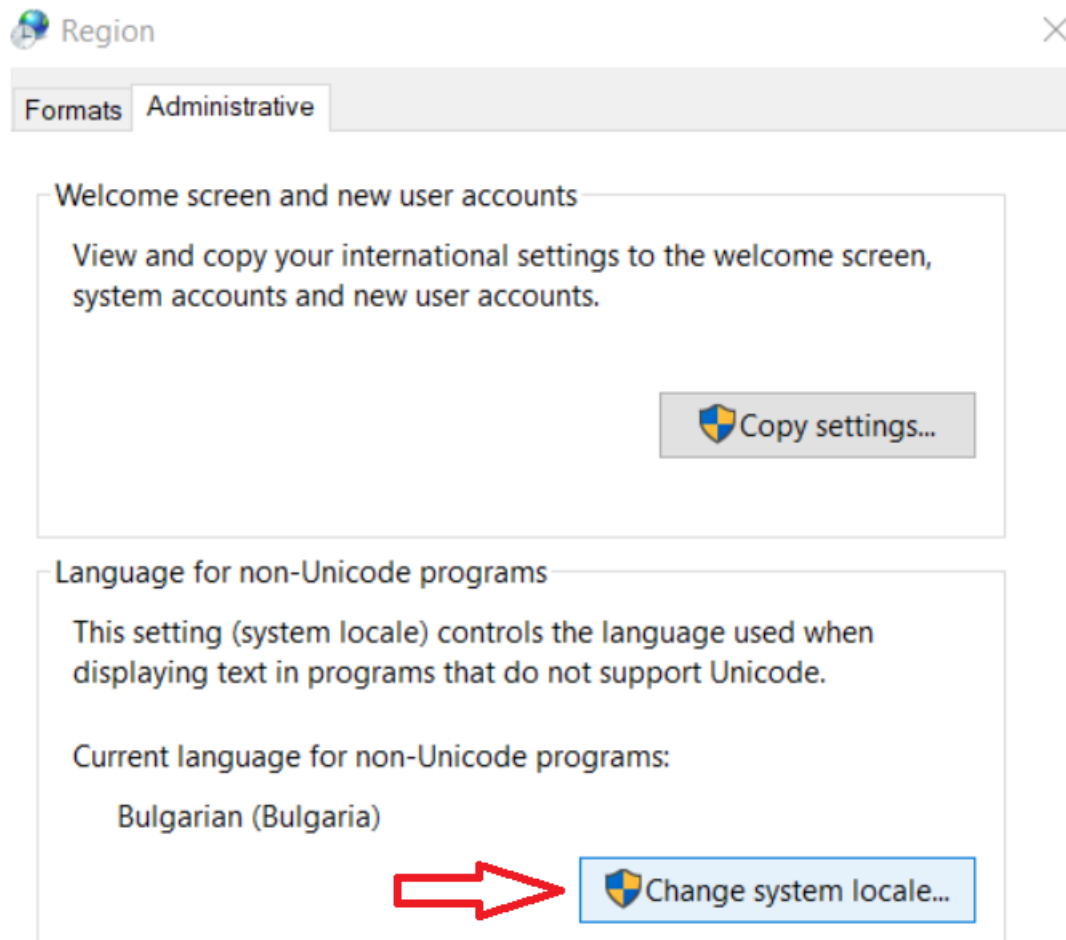

Go to: **“Change system locale settings”**

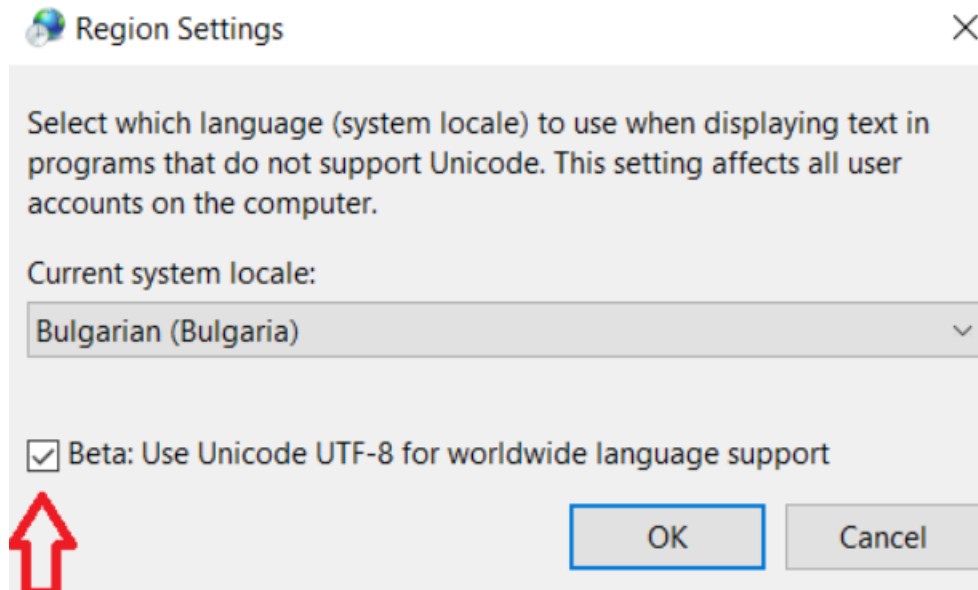

## 11. Add new fire devices to XML configuration

In case of adding a new loop or new loop controller, use option of addressing only the new elements of the fire system. Generated partial 7000M-p-1-m-1-loop-2-AUTO.xml file can be added to the existing xml configuration by configuration software WinUniConfig using option **“Export/Import”**.

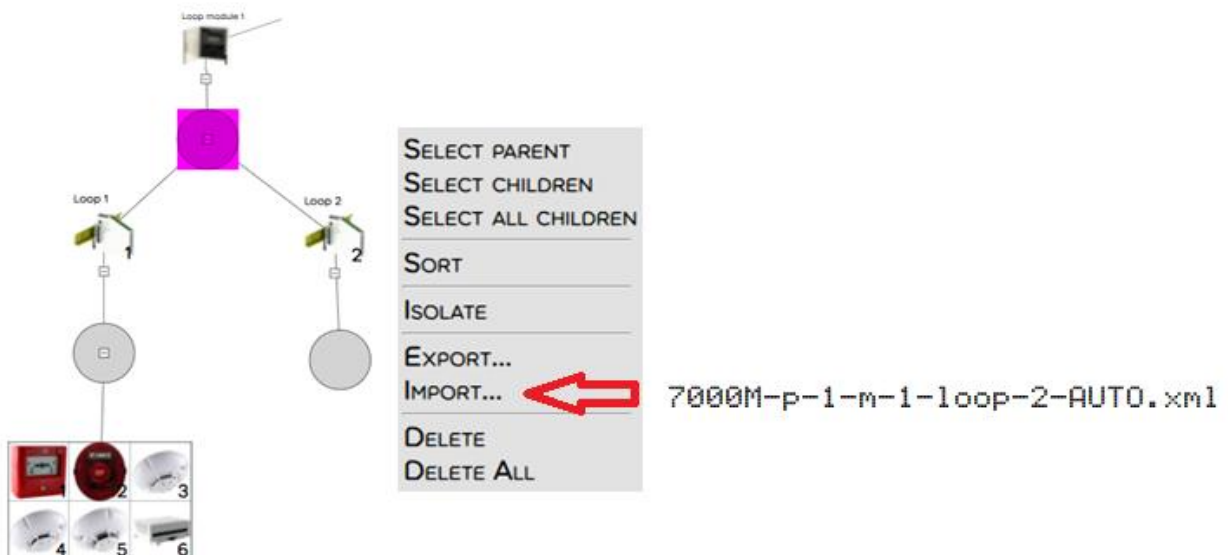

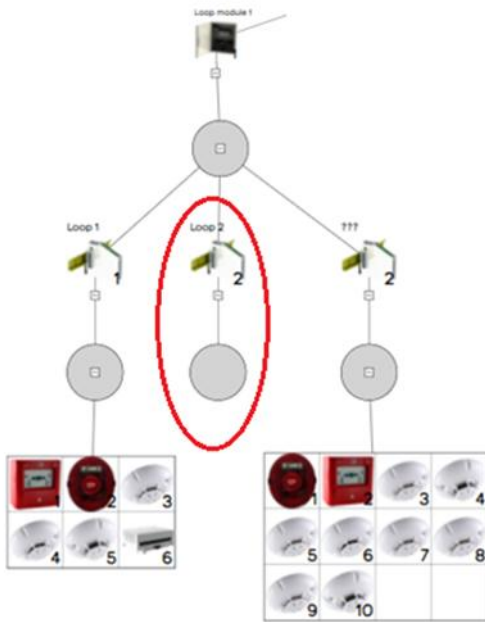

### Delete old loop 2

Now, the new loop 2 is added to existing xml file and it's ready for configuration.

**Note: Do not mix 7000M and 7000-1MC or 7000M-1L configuration elements, when using “Export/Import” function!**

## 12. CAN network configuration

Configuration of panels in a network is established over unifying the XML file of all panel configurations connected in one CAN network.

After the Addressing of the contours of the panels involved in

The CAN network (e.g. 3 panels – the other two are added to the first XML and unique numbers 1, 2, 3 are placed on the panels). The addition is done with the Export function at the panel level:

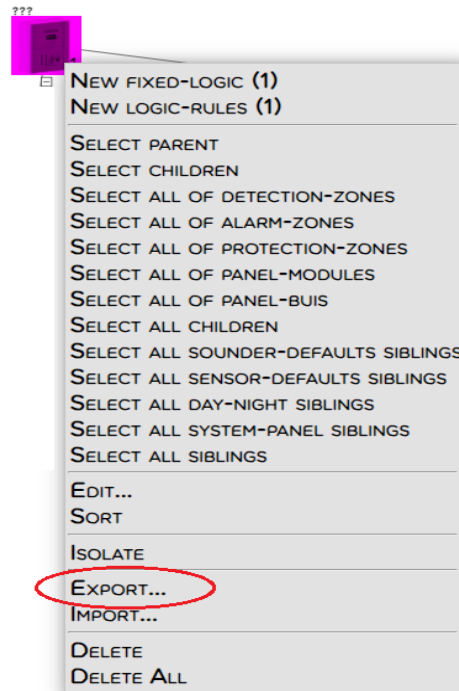

Repeat for the third panel.

Now the export information from the second and third panels must be imported into the configuration of the first panel. Performed by level: "System config":

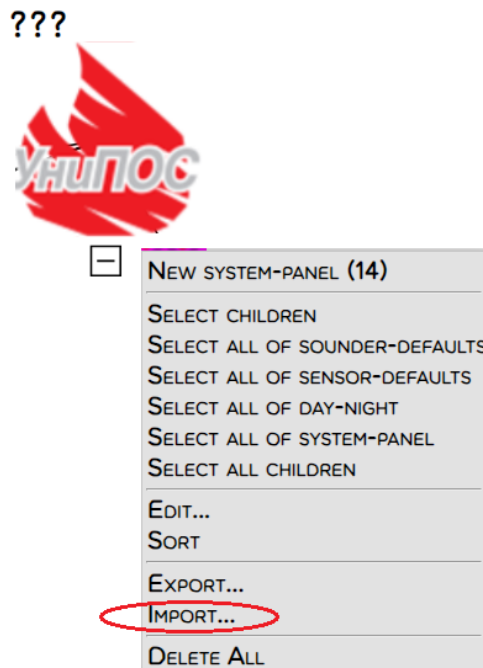

In this way, a common XML configuration file of the panels participating in a CAN network is assembled.

**Important:**

1. There should be no duplication of D/A/P zone numbers.
2. Each D-zone to participate in the operation of the A and P-zones only on loop level. Please don't mix relations of D/A/P zones between loops in one panel or between different panels.
3. Each panel must have a unique number.

After the configuration of the panels in a network is completed, a separate 7000M.sh file must be generated. Please note that each 7000M.sh file is unique for each panel according to the unique panel number in the configuration.

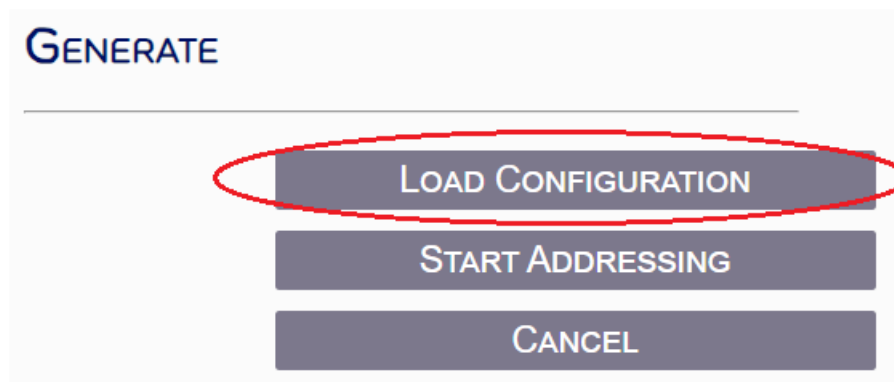
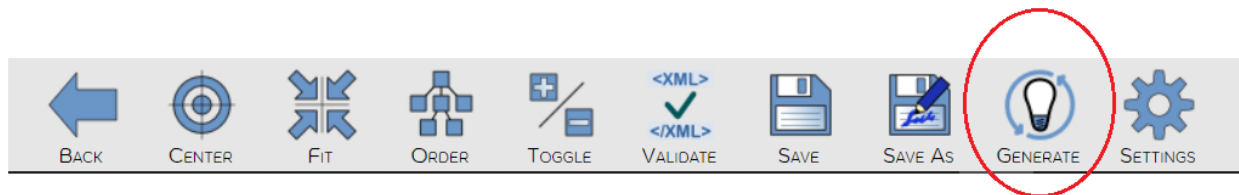

A zip file is generated containing the 7000M.sh files for each panel of the configuration.

Important: 7000M.sh and 7000M-full-system.xml files are saved in each panel with a flash drive via the System->USB-copy->Update menu.

(eg: From the Panel 1 folder, the file 7000M.sh is copied and together with 7000M-full-system.xml are copied to panel 1 of the configuration).

### 13. 7000-1MC/7000M-1L – USB driver installation

In case when Windows can't find the 7000-1MC/7000M-1L USB driver, please visit

<https://unipos-bg.com/> section /Driver download/ and get the driver's patch. Go to menu Device Manager:

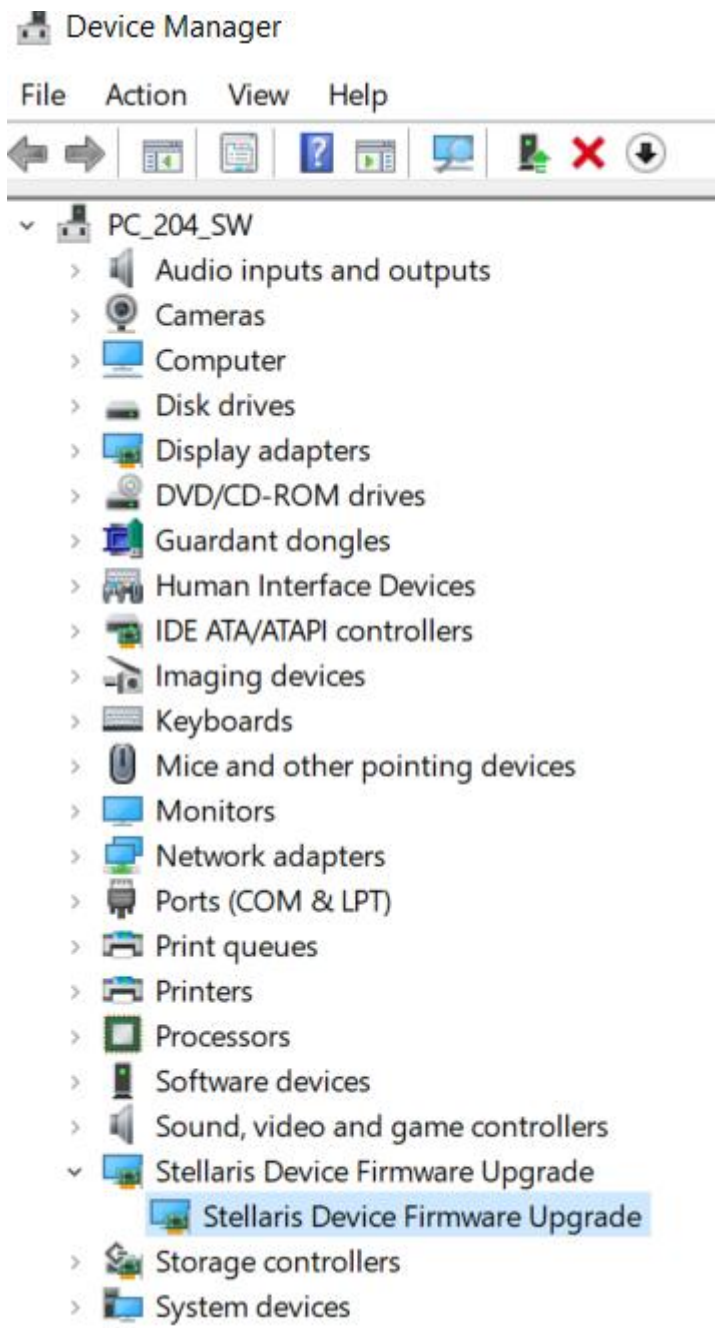

## Use the patch to update “Stellaris Device”

